

SILAMPOS

SINCE
1951



eco
COOK

MADE IN
PORTUGAL

CATÁLOGO DE PRODUCTOS • PRODUCT CATALOGUE

ÍNDICE

INTRODUÇÃO INTRODUCTION

Toda a vida For a lifetime	006
Marcos Históricos History Timeline	008
Fabricado em Portugal com paixão Made in Portugal with passion	012
A Escolha dos Chefs Chefs' Choice	014
Silamos com Arte Silamos & Art	016
Estilo mediterrânico Mediterranean spirit	020
Conceito Eco cook Eco cook concept	024
Especificações técnicas Technical specifications	028
Tecnologia Technology	030
Utilização Use	032
Garantia Warranty	034

LOUÇA DE COZINHA COOKWARE 037

PREMIUM

Supreme Essence	040
Supreme Prof	046

SELECTION

Heritage	054
Comfort	056
Comfort Glass	060
Comfort Glass Black	062
Comfort Glass Bege	064
Yumi	066
Yumi Glass	068
Atlântico Glass	070
Nautilus	072
Nautilus Glass	076
Oceanus Satin Glass	080
Professional Tejo 2000	082
Professional Tejo	086

TRADITION

Domus	092
Europa	094

BASIC

Low Cost Essential	100
Low Cost Essential Glass	102
Low Cost Classic	104
Low Cost Classic Glass	106

HORECA

GrandHotel	110
------------	-----

FAÇA O SEU CONJUNTO

Caixas Packaging	118
Kit Embalagem Box Kit	119
Mangas de Frigideiras Cookware sleeves	121

COZINHA NO MUNDO WORLD CUISINE 123

Frigideiras Fry Pans	124
Cataplanas	126
Woks	128
Frigideiras/Fritadeiras Fry Pans/Chip Pans	132
Caçarolas/Fritadeiras Casseroles/Chip Pans	134
Grelhadores Quadrados Square Grills	136
Grelhadores Circulares Round Grills	137
Paellera Paella Pan	138
Cozer a Vapor Steamers	140
Couscoussier	142
Tutti-Pasta	144
Panela Escorredora Straining Pot	148
Fondues	150
Grelhador de Pedra Stone Grill	153
Tabuleiros Oven Tray	154
Escoadores Colanders	158
Cafeteira Siena Siena Teapot	160

ANTIADERENTES NON STICK COOKWARE 162

Antiaderentes Vénus Vénus Non Stick Cookware	164
--	-----

PANELAS DE PRESSÃO PRESSURE COOKERS 166

Startwist	168
Open Control	174
Tradicional Aço Inox Traditional Stainless Steel	176
Tradicional Aço Inox Vermelha Red Traditional Stainless Steel	178
Tradicional Alumínio Traditional Aluminium	182
Easy	186

FAQUEIROS CUTLERY SET 190

RECEITA RECIPE 192

ARROZ DE CAMARÕES, TOMATE, AIPO E HORTELÃ PRAWN, TOMATOES, CELERY AND MINT RICE

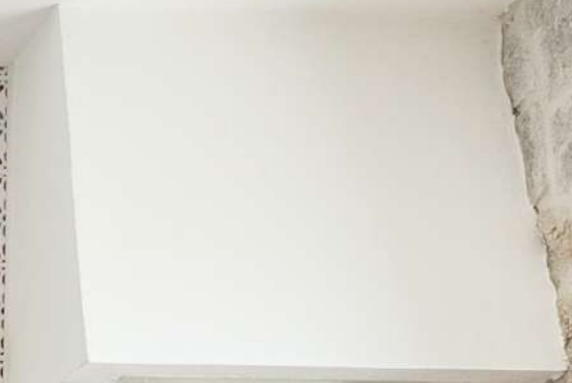

TODA A VIDA

FOR A LIFETIME

Enquanto fabricante português, assumimos a influência das tendências Europeias no Design e produção de utensílios que se destacam pela sua qualidade, destinados à casa e em particular à cozinha, como resposta de excelência aos seus vários momentos que incluem preparar, confeccionar e servir à mesa, em contexto doméstico ou profissional.

A liderança do mercado português aliada ao prestígio internacional que a marca tem vivenciado em mais de 50 países reflete a vontade dos utilizadores mais sofisticados, informados e exigentes em acompanharem as novas tendências de mercado.

Hoje com a perceção de um mundo mais pequeno, sentimos que a nossa identidade estimula inspiração por toda a parte.

Muitas vezes contamos a nossa história com base em acontecimentos quase exclusivamente associados à introdução de inovação, quer seja nos processos tecnológicos, nos modelos de negócio ou nos nossos produtos. Desde a sua fundação em 1951, data em que iniciamos o fabrico de louça metálica, temos consciência da importância de todos os fatores que contribuíram para afirmar a diferenciação da Silampos face aos seus mais diretos concorrentes. Nos últimos 70 anos procuramos antecipar as necessidades dos nossos clientes e dotar as nossas infra-estruturas de meios tecnológicos atualizados, que permitiram evoluir no sentido de darmos uma resposta mais eficiente e concordante com os ideais de elevada qualidade estética, funcional e técnica. Entendemos a inovação como um processo, mais do que um resultado. Beneficiamos de uma forte imagem de marca, sobretudo porque fomos capazes de merecer a confiança dos clientes e consumidores ao longo dos anos.

Queremos afirmar e ampliar a nossa notoriedade, reforçar o design de comunicação e as atividades de desenvolvimento de produto como meio de incorporar mais valias pelo reforço da sua capacidade de diferenciação em ambientes concorrenciais, num quadro de globalização.

Conscientes de que a ideia de “experiência” e de “identificação” é cada vez mais valorizada pelos consumidores, e nessa perspetiva, temos de rever sistematicamente os modelos de desenvolvimento de produto e da marca. Queremos que os produtos comuniquem os nossos valores e possam fazer parte da vida de todas as pessoas, proporcionando-lhes boas experiências.

As a Portuguese manufacturer, we assume the influences of European trends in the design and manufacture of utensils that stand out for their quality, intended for the home and the kitchen in particular, as a response of excellence to its several stages, including preparing, cooking and serving food, whether in a domestic or professional context.

The market leader position in Portugal and in the UK, as well as the international recognition that the brand has experienced in over 50 countries, reflects the willingness of the most sophisticated, informed and demanding costumers to follow new market trends.

Today, with the perception of a smaller world, we feel that our identity stimulates inspiration everywhere.

We often tell our story based on events almost exclusively associated with the introduction of innovation, whether in the technological processes, the business models or in our products. Since our foundation in 1951, when we started manufacturing metal cookware, we are aware of the importance of all the factors that have contributed to strengthening the differentiation of Silampos from its most direct competitors. In the last 70 years we have tried to anticipate the needs of our customers and have equipped our infrastructures with up-to-date technological means, which allowed us to evolve in order to provide a more efficient response, always following ideals of high aesthetic, functional and technical quality. We see innovation as a process, more than as a result. We now enjoy a strong brand image, mainly because we were able to earn the trust of customers and consumers alike over the years.

We want to confirm and expand our recognition, to reinforce the communication design and the product development activities as a means of incorporating added value, by strengthening our capacity for differentiation in competitive environments, within a context of globalisation.

Aware that the idea of “experience” and “identification” is increasingly valued by consumers, we need to systematically revise our product and brand development models. We want the products to communicate our values and for them to be part of the lives of all people, offering them great experiences.



ANÍBAL CAMPOS
Administrador Silampos
Silampos manager



JULIETA CAMPOS
Administradora Silampos
Silampos manager

70
1951
2021
ANOS · YEARS
SILAMPOS

Na comemoração deste longo percurso de 70 anos é o caminho de futuro que temos de partilhar. Tal como outrora, a Silampos assume-se e projeta-se nos anos vindouros como fabricantes de utensílios destinados à cozinha e mesa, disponibilizando uma resposta de excelência aos vários momentos que incluem preparar, confeccionar e servir à mesa no canal doméstico e horeca. Os principais produtos são a louça para cozinhar em aço inoxidável, as panelas de pressão, o must da empresa, e a gama para hotelaria, concebida para responder às necessidades dos chefs de cozinha. Prevemos crescer em vendas e alcançar nível de atividade e negócio consistente com a estrutura técnica e sustentabilidade económica e financeira, assentes em valores sociais coerentes com os princípios e o legado do passado e acomodando preocupações de hoje, designadamente ambientais. A estratégia assenta no bom posicionamento da marca em mercados-alvo, no reforço de parcerias que procuram a produção de qualidade e Made in Portugal. A gratidão é impossível de traduzir em palavras, mas assinalar os 70 anos da empresa é também a oportunidade para reafirmar o agradecimento aos que nos antecederam, aos nossos colaboradores, clientes, fornecedores e demais parceiros, e afirmar o orgulho do seu legado, levando ou criando condições para levar mais longe o que há 70 anos foi iniciado.

In memory of this long journey of 70 years, it is the path to the future that we must share. As previously, Silampos assumes and projects itself in the years to come as a manufacturer of kitchen and table articles, providing an excellent response to the various moments that include preparing, cooking, and serving at the table in the domestic and horeca channel. The main products are the stainless steel cookware, pressure cookers, the company's must, and the horeca range, made to meet the needs of chefs. We plan to grow in sales and reach a level of business activity consistent with the technical structure and economic and financial sustainability, based on social values matching with the principles and legacy of the past and accommodating today's concerns, namely environmental. The strategy is based on good brand positioning in target markets, strengthening partnerships that seek quality production and made in Portugal. Gratitude is impossible to translate into words but marking the company's 70th anniversary is also an opportunity to reaffirm gratitude to those who preceded us, to our employees, customers, suppliers, and other partners, and to affirm pride in what we have left behind, creating conditions to take further what was started 70 years ago.

MARCOS HISTÓRICOS

HISTORY TIMELINE



1951

A Silampos foi fundada no ano de 1951 em Cesar, no concelho de Oliveira de Azeméis.

Silampos has been started in 1951, in Cesar (Oliveira de Azeméis - Portugal).

1961

Produziu na década de 60 a primeira panela de pressão em Portugal, produto pelo qual a marca Silampos ficou reconhecida a nível nacional e internacional.

Produced back in the 60's, the first pressure cooker in Portugal, which brought nationwide fame and recognition to the company.

Finais da década de 70

Especializou-se na produção de louça em aço inoxidável, desenvolvendo desde então todo um know-how que posiciona atualmente a Silampos no topo da tecnologia na fileira industrial de louça metálica.

Back in early 70's

Silampos became specialist in the production of stainless steel cookware, and developed since then its current product range.

1978

Ocorreu a alteração do pacto social que transformou a empresa em sociedade unifamiliar, permitindo a convergência da gestão e o delinear de um programa de reatracamento que garantiu a prossecução do escopo capacidade/produzitividade/qualidade, necessário à consolidação da Silampos no mercado interno e a entrada na exportação.

Campos family took the lead of Silampos and that has enabled the company restructuring and equipment acquisition with the aim to improve the capacity / productivity / quality trilogy needed to strengthen the position in the domestic market and break into the export markets. That move enabled Silampos to become the most important Portuguese company in the metallic cookware sector for residential use.

1993

Foi concluído o audacioso programa de investimento, que dotou a Silampos da mais avançada tecnologia então disponível-Impact Disc para fabrico de louça metálica.

The company has been investing systematically in technology in order to be up-to-date and in 1993 has bought namely the Impact Disc Plus system for metallic cookware production.

1996

Em 1996, a Silampos alcançou a certificação do seu sistema de Qualidade, implementado de acordo com a norma ISO 9001.

In 1996, Silampos achieved the certification of its Quality System, implemented in accordance with ISO 9001.

2000

A Silampos UK adquiriu em 2000 as empresas inglesas Horwood Homewares, Ltd e Kaufmann Ltd, as quais foram vendidas em 2016.

Silampos UK group acquired the British companies Horwood Homewares Ltd and Kaufmann Ltd, which were sold in 2016.

2001

Foi transformada em Sociedade Anónima, com capital social de 4.000.000,00€ controlado na totalidade pela família Campos, fundadora da empresa.

By the end of 2001, Silampos became a private limited company with a share of capital of 4.000.000.00 euros totally owned by Campos family who started the company.

2004

Verificou-se a entrada no mercado de hotelaria e restauração, através da produção de uma linha de louça industrial em aço inoxidável pensada para responder às principais exigências dos grandes Chefs de cozinha.

Silampos broke into the hotel and restaurant market with a customized stainless steel industrial cookware collection, designed to meet the major demands of the Chefs.

2005

Desenvolveu a louça Multidisc, linha topo de gama concretizando um salto tecnológico significativo em termos de consumos de energia, tempos e temperaturas de cozedura. A sofisticação do produto Multidisc dispensa o fundo térmico, mas acolhe as vantagens deste, extrapolando para todo o corpo da peça as respetivas características térmicas.

Silampos developed the Multidisc cookware, a top of the line collection, that enables significant energy consumption and time savings. This technology uses the most sophisticated thermal bases, thus enabling the entire piece to take full advantage of the benefits of the base.

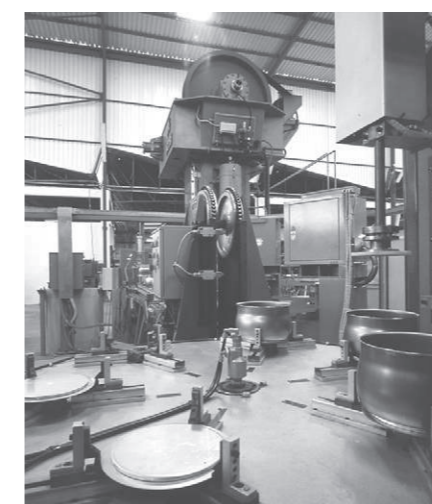

2006

Com o intuito de estar presente em todos os segmentos de mercado, criou em 2006 a marca Cook Silampos para atuar nas grandes superfícies.

In order to present in all market segments, the brand Cook Silampos was created to be sold in large retail stores.

2008

Encara outras oportunidades com afinidade tecnológica e produtiva da área "Cooking", com o desenvolvimento do Garden Grill, um grelhador de exterior a gás.

Silampos has been centring its activity in the cooking area, now it is time to consider other opportunities related to technological and production development for instance the Garden Grill, an outdoor gas grill.

2010

Criou uma marca dedicada ao mobiliário urbano, a Silampos Urban, que reflete a expansão da Silampos para diferentes áreas de negócio, tendo presente as suas raízes, os altos níveis de exigência e o conhecimento adquirido pela empresa para o desenvolvimento de produto. Envolve as atividades de Design, Engenharia de Produto e o Marketing da Silampos, concebe, desenvolve e comercializa produtos funcionais e emblemáticos reservados a espaços públicos, semi-públicos e privados, para interior e exterior.

Created a brand entirely dedicated to street furniture: Silampos Urban, which is the result of the expansion in different business areas, referring to its roots, high levels of demand and know-how acquired by the company for product development. It involves the activities of Design, Product Engineering and Marketing, which develop and sell functional and symbolic products for public, semi public and private spaces, indoor and outdoor.

2015

Em Março de 2015, a Silampos obteve a certificação ambiental ISO 14001. Faz parte dos únicos fabricantes de louça metálica no mundo a obter e o primeiro em Portugal a fazê-lo.

In March 2015, Silampos registered an ISO 14001 environmental certification. We are among the only manufacturers of cookware in the world to obtain and the first in Portugal.

Em Julho 2015, conseguiu a certificação da ISO 50001, correspondente à gestão de energia. Na prossecução da eficiência somos das primeiras empresas, a nível mundial, a conseguir a certificação da gestão de energia.

In July 2015, Silampos achieved ISO 50001 certification, corresponding to energy management. In pursuit of efficiency, we are one of the first companies worldwide to achieve energy management certification.



2019

Lançamento da Panela de Pressão Startwist. Apresenta um novo sistema de fecho e abertura por garras e distingue-se pela sua qualidade, estética, funcionalidade e de segurança.

Startwist Pressure Cooker launching. It has a new closing and opening clamp system and stands out for its quality, aesthetics, functionality and safety.



2023

Lançamento do Heritage, um modelo Retro Revival com revestimento exterior de cor verde e acessórios dourados com revestimento em titânio PVD.

Launch of the Heritage, a *Retro Revival* model with green exterior coating and golden solden handles with titanium coating PVD.



FABRICADO EM PORTUGAL COM *PAIXÃO*

MADE IN PORTUGAL WITH *PASSION*

Somos uma marca portuguesa com inspiração vinda da terra e do mar. Estes elementos que constroem a personalidade portuguesa são refletidos no desenvolvimento dos produtos da Silampos que ajudam as pessoas a confeccionarem as melhores receitas.

A costa portuguesa é extensa e formou belas praias, com variedade entre falésias e areais. As águas marinhas portuguesas são umas das mais ricas em biodiversidade do mundo. As espécies marinhas são na ordem dos milhares e incluem a sardinha, o atum e a cavala. Em Portugal também é possível observar o fenómeno de ressurgência, especialmente na costa oeste, que torna o mar extremamente rico em nutrientes e biodiversidade. O país é todo banhado pelo oceano Atlântico mas o Algarve, a região mais a sul do país está sob a influência do Mar Mediterrâneo.

Grandes e famosos Chefs, da Europa à Ásia, dos Estados Unidos ao Japão, reconhecem o nosso peixe como sendo o melhor do mundo.

É neste país com uma cultura, gastronomia e património únicos que fabricamos os nossos produtos com muita paixão.

We are a Portuguese brand inspired by the land and the sea. These elements that shape the Portuguese personality are only reflected in the development of Silampos products that help people prepare the best recipes.

The Portuguese coast is extensive and made up of beautiful beaches, with variety between coasts and beaches. Portuguese marine waters are one of the richest world biodiversity. Marine species number in the order of two thousand and include sardines, tuna and mackerel. In Portugal, it is also possible to observe the resurgence phenomenon, especially on the west coast, which makes the sea extremely rich in nutrients and biodiversity. The country is entirely bathed by the Atlantic Ocean but the Algarve, the country's southernmost region, is under the influence of the Mediterranean Sea.

Great and famous Chefs, from Europe to Asia, or United States to Japan, recognize our people as the best in the world.

In this country with a unique culture, gastronomy and heritage, we manufacture our products with a lot of passion.





Chef
Camilo Jaña

Chef
Vitor Sobral

Chef
Lígia Santos

Chef
Henrique Sá
Pessoa

Chef
Chakall

A ESCOLHA DOS CHEFES

CHEFS' CHOICE



SILAMPOS COM ARTE

SILAMPOS & ART

ARTISTA PLÁSTICA JOANA VASCONCELOS

Que significado pretende alcançar com a utilização nas suas obras de artefactos que remetem para arte tradicional portuguesa?

Tal como outros aspetos da minha subjetividade, o facto de ser Portuguesa condiciona a forma como me relaciono com o mundo. Contudo, este particularismo é apenas um ponto de partida para articular questões universais, porque o que me interessa é o diálogo entre tradições e experiências, entre o que é Português e o que é feito pelo mundo fora e esta justaposição de referências locais e globais. No fundo, o que é realmente importante é comunicar além fronteiras.

Qual o valor icónico do sapato feito com caçarolas da Silampos?

A série de sapatos feitos com caçarolas Silampos tem uma vasta carga simbólica, partindo mesmo dos títulos destas obras, que remetem a personagens femininas icónicas (Marilyn, Cinderela, etc) e passando pela associação improvável entre as caçarolas e o sapato de salto alto, justapondo assim os papéis contrastantes da Mulher na sociedade, independentemente da sua origem: o desempenho social e o doméstico. A grande familiaridade da marca Silampos serve também para o aproximar mais intimamente do público.

Enquanto utilizador o que lhe agrada mais na marca Silampos?

Tanto na habitual utilização doméstica como enquanto artista, admiro a forma como se imprimiu na memória coletiva dos portugueses e, mais do que uma marca, se tornou um sinónimo dos seus próprios produtos em Portugal.

Em 2007 a Silampos começou a fornecer à artista contemporânea Joana Vasconcelos as panelas que deram vida a uma série de sapatos com cerca de 3 metros de altura.

É a primeira artista portuguesa a expor no Palácio de Versalhes em Paris. Nesta exposição, que foi inaugurada no dia 19 de Setembro de 2012, decidiu "dialogar com a história e a estética do lugar, cruzando-as com as técnicas tradicionais portuguesas, uma homenagem às mulheres que lá viveram e mudaram o curso da história".

ARTIST JOANA VASCONCELOS

What meaning do you intend to accomplish in your own works by using artefacts that relate to traditional Portuguese art?

Like other aspects of my subjectivity, the fact of being Portuguese influences how I relate to the world. However, this particularity is only a point of departure to articulate universal issues, because what interests me is the dialog between traditions and experiences, between what is Portuguese and what is made around the world and this juxtaposition of local and global references. In the end, what is really important is to communicate across borders.

What is the iconic value of the shoe made with Silampos' casseroles?

The shoes' series made with Silampos's casseroles has a great symbolic significance, starting from the titles of these works, which refer to iconic female characters (Marilyn, Cinderella, etc.), and from the unlikely association between casseroles and high-heeled shoes, contrasting the roles of Women in society, regardless of their origin: the social performance and the domestic context. The wide recognition of the Silampos brand also serves to bring the public more closely to the work.

As a consumer, what do you like the most about the Silampos brand?

Both as a normal domestic user and as an artist, I admire the way that the brand has made itself part of the collective memory of the Portuguese people, and more than a brand, has become a synonym of its own products in Portugal.

In 2007, Silampos began providing the contemporary artist Joana Vasconcelos the pans that gave life to a series of approximately 3 meter high shoes.

Vasconcelos is the first Portuguese artist to exhibit at the Palace of Versailles in Paris. In this exhibition, which was inaugurated on the 19th of September 2012, the artist decided to "start a dialogue between the history and the aesthetics of the place, crossing them with traditional Portuguese techniques, a tribute to the women who lived there and changed the course of history".





Joana Vasconcelos é a primeira mulher a expor no Palácio de Versalhes em Paris depois do americano Jeff Koons, do japonês Takashi Murakami e dos franceses Xavier Veilhan e Bernar Venet.

Joana Vasconcelos is the first woman to hold an exhibition at the Palace of Versailles in Paris, after the American Jeff Koons, the Japanese Takashi Murakami and the French Xavier Veilhan and Bernar Venet.

Na Galerie des Glaces foi montada ao fundo, a poucos metros da porta que dá acesso ao Salão da Paz, uma das peças-chave da exposição: “Marilyn”, um gigantesco, cintilante e muito elegante par de sapatos de salto alto, que se integra com uma paradoxal desarmonia no fabuloso conjunto destinado a exaltar o poder absoluto do rei. Os sapatos, construídos com caçarolas de aço inoxidável da Silampos, associam o seu brilho fulgurante aos 357 espelhos do majestático salão e, como os de Dorothy (“Feiticeiro de Oz”), são mágicos. A sua simples presença no palco da soberania mais total conduz a uma estonteante metamorfose no visitante, que é transformado, de repente, em criança. O par de sapatos muda tudo no teatro de espelhos, pinturas exaltantes e ornamentos dourados: abre a porta ao mais maravilhoso dos feitiços e à viagem num mundo imaginário habitado por graciosas mulheres. Feminista e feminina, diz com fulgor especial junto às caçarolas que são motivos naturais tornados em luxo, é a mulher contemporânea dividida entre a casa, a família e a sua função pública; os sapatos são o símbolo das mulheres, do glamour, as caçarolas representam a vida tradicional.

At the end of the Galerie des Glaces, a few meters from the door leading to the Salon de la Paix, we can find one of the key pieces of the exhibition: “Marilyn”, a gigantic, scintillating and very stylish pair of high heeled shoes, integrated with a paradoxical disharmony in the fabulous set intended to exalt the absolute power of the King. The shoes, made with Silampos’ stainless steel casseroles, associate their blinding brightness to the 357 mirrors of the majestic room and, like Dorothy’s shoes (“Wizard of Oz”), are magical. Their mere presence on the stage of the most complete sovereignty leads to a stunning metamorphosis of the visitor, which is suddenly transformed into a child. The pair of shoes changes everything in the theatre of mirrors, exciting paintings and gold ornaments: it opens a door to the most wonderful of spells and to a voyage in an imaginary world inhabited by graceful women. Feminist and feminine - Vanconcelos says with special enthusiasm next to the casseroles that are natural motifs turned into luxury - is the contemporary woman divided between the home, the family and her public role; the shoes are the symbol of women, of glamour, and the casseroles represent the traditional life.



Luís Vasconcelos/©Unidade Infinita Projectos

ESTILO MEDITERRÂNICO

MEDITERRANEAN SPIRIT

O Mediterrâneo é a região turística mais visitada no mundo devido ao seu património histórico, cultural, natural e paisagístico.

Mas o mediterrâneo é mais do que um lugar. É um espírito que nos acompanha para todo o lado.

A dieta mediterrânica promove um padrão de ingestão alimentar baseado na diversidade, nos produtos locais e da época, na predominância de produtos vegetais frescos, a procura de sabores genuínos. Selecciona o azeite como gordura principal, estão presentes as leguminosas e o pão de qualidade, a água e o vinho.

É uma forma de nos alimentarmos bem, um estilo de viver bem!

The Mediterranean is the most visited tourism region in the world due to its historical, cultural, natural and landscape heritage.

But the Mediterranean is more than a place. It's a spirit that follows us everywhere.

The Mediterranean diet promotes a pattern of food intake based on diversity, on local and seasonal products, the predominance of fresh vegetables, the search for genuine flavours. It selects olive oil as the main source of fat, and includes vegetables and quality bread, as well as water and wine.

It's a way of eating well, a style of living well!



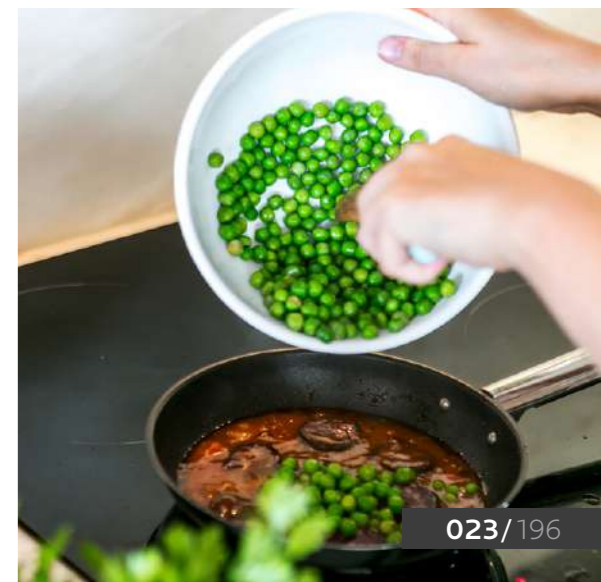

CONCEITO ECO COOK

ECO COOK CONCEPT

ECOCOOK E ECONOMIA CIRCULAR

ECOCOOK AND CIRCULAR ECONOMY

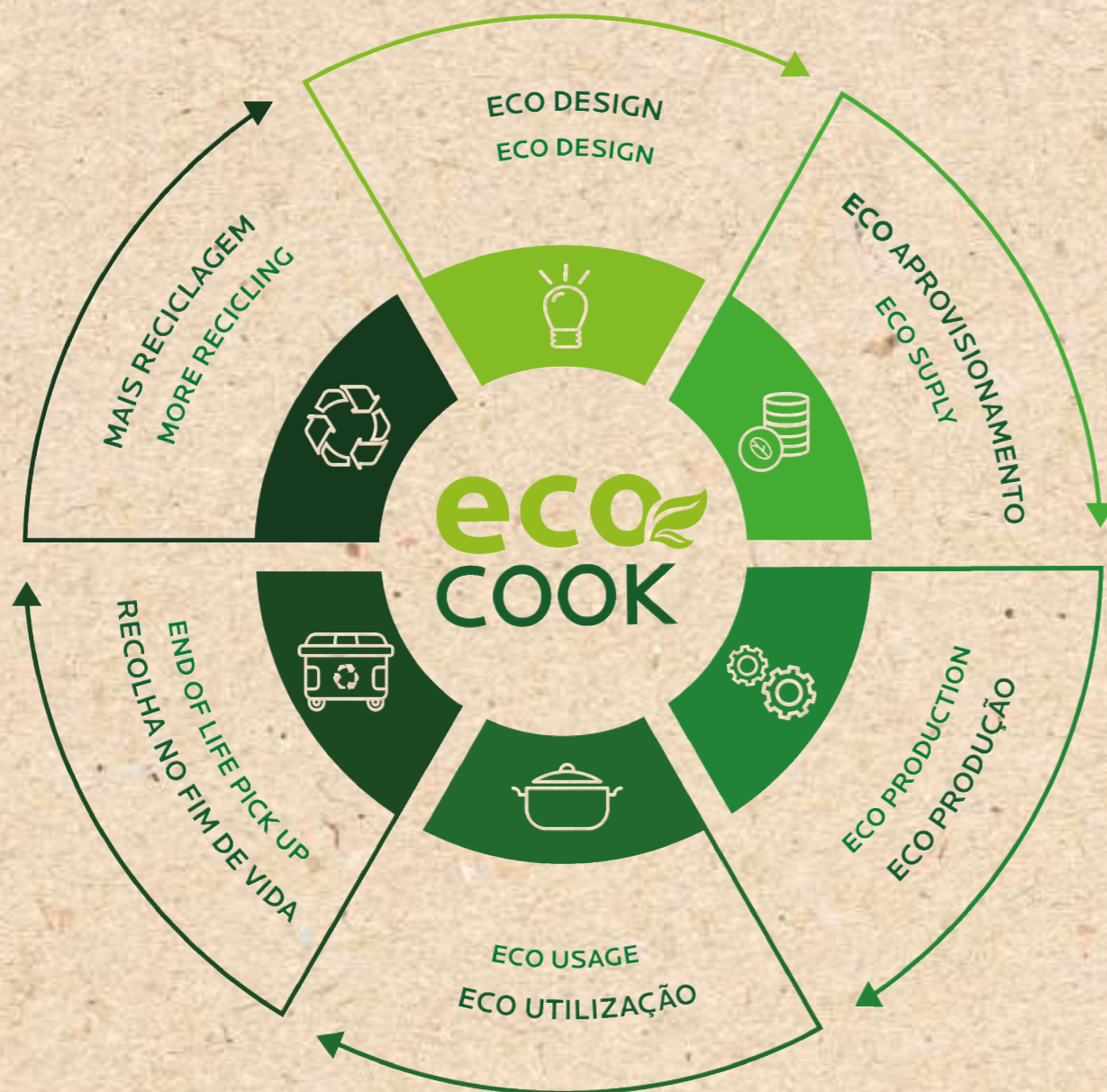

Eco Design

- Seleção de materiais com baixo impacto ambiental e menos poluentes
- *Selection of materials with low environmental impact and less polluting:*
- Decisão baseada em análise de ciclo de vida
- *Decision based on life cycle analysis*
- Seleção da embalagem com menor intensidade de plástico ou papel com proveniência sustentável
- *Selecting lower intensity packaging of proven sustainability plastic or paper*
- Otimização do tempo de vida útil: maior durabilidade; mais reparabilidade e mais modularidade
- *Lifetime optimization: increased utilization; more repairability and more modularity*
- Otimização do sistema de fim de vida
- *End-of-life system optimization*



Eco Aproveitamento Eco Supply

- Privilegiar Fornecedores de proximidade
- *Proximity Providers*
- Simbiose industrial em operações logísticas
- *Industrial symbiosis in logistics operations*
- Materiais reciclados
- *Recycled Materials*
- Materiais recicláveis
- *Recyclable materials*
- Materiais com menos poluentes
- *Materials with less pollutants*



Eco Produção Eco Production

- Tecnologias mais limpas
- *Cleaner Technologies*
- Tecnologias com maior eficiência energética
- *More energy efficient technologies*
- Recurso a energias renováveis
- *Use of renewable energy*
- Otimização das técnicas de produção
- *Optimization of production techniques*
- Mudança comportamental
- *Behavioural change*



Eco Utilização Eco Usage

- Prolongamento do tempo de vida útil
- *Extended Life*
- Conselhos de utilização e preservação do produto
- *Product use and storage advise*
- Serviço de AAV / Serviço ao consumidor
- *Post sales service/ Customer service*



Recolha em fim de vida End of Life Pick Up

- Informação ao consumidor em como proceder
- *Consumer information on how to proceed*



Mais reciclagem More recycling

- Mais reciclagem dos resíduos gerados.
- *More recycling of waste generated*
- Mais reciclagem das peças em fim de vida
- *More recycling of end-of-life parts*



CONCEITO ECO COOK

ECO COOK CONCEPT

A ORGANIZAÇÃO

THE ORGANISATION

A qualidade é um conceito transversal à organização Silamos, presente desde a criação dos seus produtos até ao apoio dado ao cliente/consumidor. Esta preocupação há muito que foi assumida como princípio fundamental de gestão tendo expressão formal na certificação do seu sistema de Qualidade desde 1996, implementado de acordo com a norma ISO 9001.

A Silamos faz parte dos únicos fabricantes de louça metálica no mundo a obter a certificação ambiental ISO 14001 e o primeiro em Portugal a fazê-lo.

Na prossecução da eficiência somos das primeiras empresas, a nível mundial, a conseguir a certificação da ISO 50001 correspondente à gestão de energia.

A aposta na utilização de matérias-primas de excelência, usando tecnologia de ponta e o conhecimento (know-how) dos seus colaboradores, nunca descuidando os princípios de preservação do meio ambiente e eficiência energética, tem contribuído para que, ao longo dos anos, a colocação no mercado de produtos que primam pelo seu desempenho funcional e qualidade seja uma constante.

A Silamos prossegue uma prática de cumprimento legal aplicável a qualquer domínio. Nesse sentido tem mecanismos implementados para responder de forma célere a questões associadas por exemplo:

- à compatibilidade alimentar dos materiais que utiliza no fabrico, cumprindo com as boas práticas existentes (Regulamento CE 1935/2004 e Regulamento CE 2023/2006).
- ao REACH, que visa melhorar a protecção da saúde humana e do ambiente; garantindo que os produtos que fabrica não contêm substâncias de elevada preocupação (SVHC - substances of very high concern).
- entre outros.

Quality is a cross-cutting concept to the entire Silamos organisation, present from the creation of its products to the support provided to customers/consumers.

This concern has long been taken as a basic principle of management, formally expressed in the certification of its Quality system since 1996, implemented in accordance with the ISO 9001 standard.

Silamos is part of the few cookware manufacturers in the world to obtain the ISO 14001 environmental certification and is the first in Portugal to do so.

In the pursuit of efficiency, we are among the first companies in the world to attain the ISO 50001 certification regarding energy management.

The investment in the use of raw materials of excellence, using cutting-edge technology and the knowledge (know-how) of its employees, never neglecting the principles for the preservation of the environment and energy efficiency, has contributed over the years to the introduction of products that excel by their functional performance and constant quality.

Silamos pursues a practice of legal compliance applicable to any domain. In this sense, it has mechanisms in place to quickly respond to issues related to, for example:

- the food compatibility of the materials used in manufacturing, by complying with existing good practices (Regulation EC 1935/2004 and Regulation EC 2023/2006)
- REACH, which aims to improve the protection of human health and the environment; ensuring that the products it manufactures do not contain substances of very high concern (SVHC).
- numerous others.

O PRODUTO

THE PRODUCT

Da constante aposta num design diferenciador resultam produtos funcionais, esteticamente apelativos e amigos do ambiente. O seu elevado desempenho garante mais rapidez na confeção dos alimentos, o que se reflete numa significativa poupança de energia e cozinhados saudáveis, características validadas regularmente através de ensaios realizados tanto no laboratório interno como em laboratórios externos acreditados para o efeito.

A louça para cozinhar da Silamos é fabricada em aço inoxidável 18/10 que apresenta uma elevada resistência à corrosão e permite o contacto direto com os alimentos, de acordo com as normas vigentes, garantindo mais higiene e durabilidade, sendo um material reciclável.

O fundo térmico aplicado possui excelentes propriedades de armazenamento e distribuição de calor, permitindo que os alimentos libertem naturalmente os seus sucos, proporcionando cozinhados saudáveis, sem que os alimentos fiquem agarrados ao fundo.

O revestimento antiaderente aplicado nas nossas frigideiras e grelhadores é de base PTFE e composto por três camadas micro-reforçado com partículas cerâmicas, de forma a assegurar a máxima durabilidade e relação entre as características de aderência e resistência à abrasão. Não contém quaisquer substâncias prejudiciais à saúde, nomeadamente PFOA, BPA, APEO, SVHCs.

Adicionalmente nas embalagens está patente a preocupação ambiental nomeadamente:

- A embalagem de transporte e caixa exterior são fabricadas em cartão 100% reciclável e impressas com tintas à base de água.
- Os sacos de plástico que envolvem os produtos são fabricados em PE, material 100% reciclável.
- Todas as embalagens utilizadas cumprem com a legislação em vigor relativamente à ausência de metais pesados, contribuindo para as metas nacionais de reciclagem.



The ongoing commitment in a unique design results in functional, aesthetically appealing and environmentally friendly products. Their high performance ensures a quicker preparation of food, which is reflected in significant energy savings and healthier cooked food, characteristics that are regularly validated through tests both performed internally and in external laboratories accredited for this purpose.

Silamos' cookware is manufactured in 18/10 stainless steel, which presents a high resistance to corrosion and allows direct contact with food, in accordance with current standards, ensuring more hygiene and durability, being manufactured in a recyclable material.

The thermal based applied to the cookware has excellent heat storage and distribution properties, allowing food to better release its juices and providing for healthier cooking, without the food sticking to the bottom.

The non-stick coating applied in our pans and grills is PTFE-based and is composed of three layers and reinforced with ceramic microparticles, so as to ensure maximum durability and the relation between the characteristics of adhesion and the resistance to abrasion. They do not contain any substances harmful to the human health, namely PFOA, BPA, APEOS, SVHCs.

Our packaging also shows our environmental concern, in particular:

- The transport package and outer box are made of 100% recyclable cardboard and printed with water-based inks.
- The plastic bags used to wrap the products are manufactured in PE, a 100% recyclable material.
- All the packaging used comply with the legislation in force regarding the absence of heavy metals, contributing to the national targets for recycling.



Empresa certificada na gestão de:







Qualidade: ISO 9001
Ambiente: ISO 14001
Energia: ISO 50001

Certified management company in:

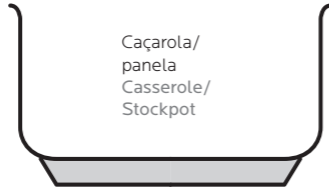
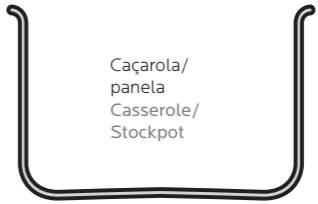
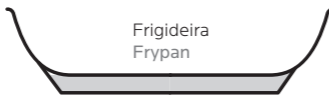
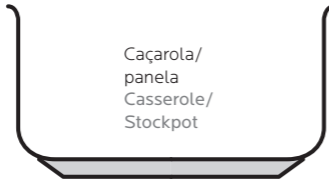
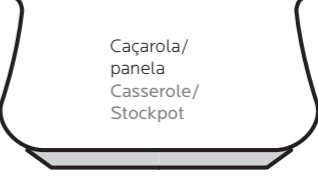
Quality: ISO 9001
Environment: ISO 14001
Energy: ISO 50001

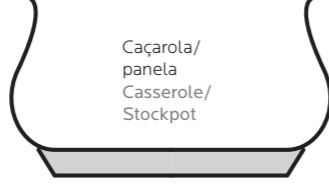
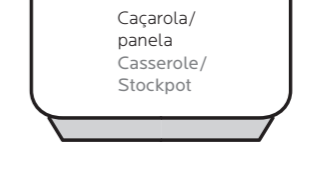
ESPECIFICAÇÕES TÉCNICAS

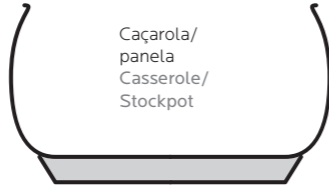
TECHNICAL SPECIFICATIONS

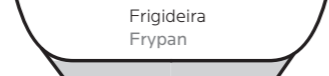
MODELO MODEL	LINHA LINE	FUNDO BOTTOM	DESENHO DRAWING	TECNOLOGIA IMPACT DISC PLUS	MODEL MODEL	LINHA LINE	FUNDO BOTTOM	DESENHO DRAWING	TECNOLOGIA MULTIDISC 3 PLY
ATLÂNTICO GLASS COMFORT COMFORT GLASS COMFORT GLASS BLACK COMFORT GLASS BEGE EUROPA HERITAGE NAUTILUS NAUTILUS GLASS PROFISSIONAL TEJO PROFISSIONAL TEJO 2000	A	6mm	 Caçarola/ panela Casserole/ Stockpot		SUPREME PROF SUPREME ESSENCE	F	2,3mm	 Caçarola/ panela Casserole/ Stockpot	
		4,7mm	 Frigideira Frypan					2,3mm	
LOW COST ESSENTIAL LOW COST ESSENTIAL GLASS	A1	4,7mm	 Caçarola/ panela Casserole/ Stockpot		LOW COST CLASSIC LOW COST CLASSIC GLASS	I	4,7mm	 Caçarola/ panela Casserole/ Stockpot	TECNOLOGIA IMPACT DISC PLUS
		4,7mm	 Frigideira Frypan					4,7mm	
DOMUS	B	6mm	 Caçarola/ panela Casserole/ Stockpot		GRAND HOTEL (</= Ø32cm)	H	6mm	 Caçarola/ panela Casserole/ Stockpot	TECNOLOGIA IMPACT DISC PLUS
		4,7mm	 Frigideira Frypan			GRAND HOTEL (> Ø32cm)		6mm	
OCEANUS SATIN GLASS YUMI YUMI GLASS	E	6mm	 Caçarola/ panela Casserole/ Stockpot		GRAND HOTEL (</= Ø32cm)		6mm	 Frigideira Frypan	
		4,7mm	 Frigideira Frypan			GRAND HOTEL		2,3mm	

A TECNOLOGIA

THE TECHNOLOGY

IMPACT DISC PLUS

FUNDO TÉRMICO COM TECNOLOGIA IMPACT DISC PLUS

A louça IMPACT DISC PLUS é o resultado de um processo de conceção e desenvolvimento de um fundo térmico versátil, com excelentes propriedades de armazenamento e condução do calor, durabilidade e resistência à corrosão.

THERMIC BOTTOM WITH IMPACT DISC PLUS TECHNOLOGY

The Impact Disc Plus cookware is the result of a design and development process for a versatile thermal base, with excellent heat storage and conduction properties, durability and resistance to corrosion.



FUNDO TÉRMICO COM DISTRIBUIÇÃO UNIFORME DE CALOR
THERMAL BASE WITH UNIFORM HEAT DISTRIBUTION

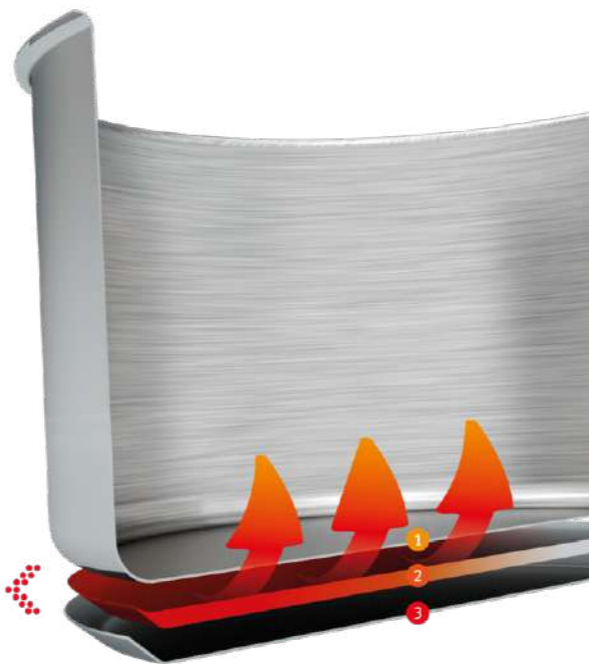

MULTIDISC 3 PLY

TECNOLOGIA MULTIDISC APLICADA AO CORPO

Com a utilização do material Multidisc é possível extrapolar para todo o corpo da peça as vantagens do fundo térmico Silamos.

- Aquecimento uniforme por toda a peça.
- Não arrefece tão rapidamente quanto a louça de cozinha tradicional.
- As camadas exteriores em aço inoxidável previnem e retardam a dissipação do calor gerado pelas camadas intermédias.

MULTIDISC TECHNOLOGY APPLIED TO THE BODY PIECE

With the use of the Multidisc technology it is now possible to extrapolate the advantages of Silamos thermal base to the entire body of the piece.

- Uniform heating throughout the piece.
- Does not cool down as quickly as traditional cookware.
- The outer layers in stainless steel prevent and delay the dissipation of the heat generated by the intermediate layers.



ELEVADA CONDUÇÃO TÉRMICA FUNDO + PAREDES TÉRMICAS
HIGH THERMAL CONDUCTIVITY THERMIC BASE + SIDE WALLS

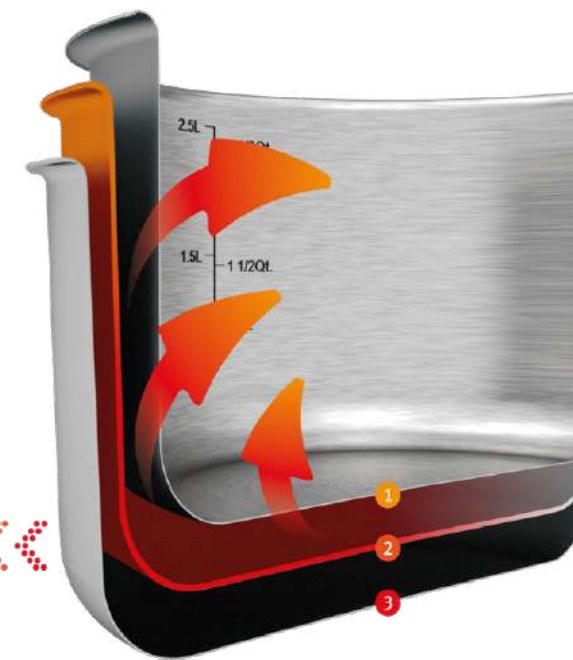

UTILIZAÇÃO

USE



A louça metálica da Silampos poupa tempo e energia

- Use calor médio nos minutos iniciais de confeção.
- Aguarde até que os líquidos comecem a ferver e os alimentos fiquem dourados.
- Depois reduza para o mínimo.
- Antes de terminar a cozedura, desligue a fonte de calor.

Qualquer que seja a fonte de calor utilizada não necessita de a usar no máximo, poupando assim energia.

O fundo térmico aplicado na louça Silampos em aço inoxidável possui excelentes propriedades de armazenamento de calor.

OS ALIMENTOS LIBERTAM MELHOR OS SEUS SUCOS PROPORCIONANDO COZINHADOS SAUDÁVEIS. A COMIDA NÃO FICA AGARRADA AO FUNDO.

Silampos cookware saves time and energy

- Use medium heat in the initial moments of the cooking.
- Wait until the liquid begins to boil and the food is lightly browned.
- At this moment use minimum heat.
- Before finishing the cooking, turn off the heat source.

Whatever the heat source used you will save energy, as there is no need to use the maximum setting.

The thermal base applied to the Silampos stainless steel cookware has excellent heat storage properties.

THE FOOD RELEASES ITS JUICES BETTER, ALLOWING FOR HEALTHIER COOKING. THE FOOD DOES NOT STICK TO THE BOTTOM.

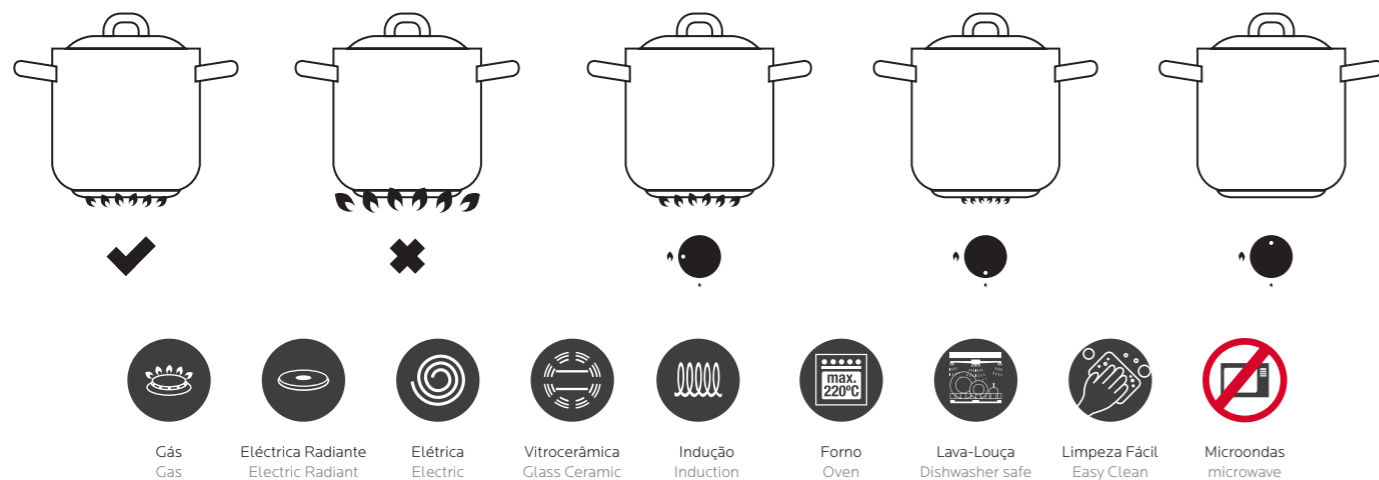

PRODUTO LIMPEZA SILAMPOS
CAIXA DE 10 UNIDADES
SILAMPOS CLEANER
10 UNITS BOX

Alt.(cm)	Capac.(ml)	Artigo
Hgh(cm)	Capac.(ml)	Article
20	250	415909019200

Para remover as manchas mais difíceis e restaurar o brilho da louça metálica

For removing stubborn stains and restoring the shine of metal cookware.



Chef Lígia Santos

Chef Henrique Sá Pessoa
2 Estrelas/ Michelin Stars

Chef Vitor Sobral

GARANTIA

WARRANTY

PRODUTO PRODUCT	MODELO MODEL	GARANTIA PRODUTO PRODUCT WARRANTY	GARANTIA FUNDO TÉRMICO THERMAL BOTTOM WARRANTY	PRODUTO PRODUCT	MODELO MODEL	GARANTIA PRODUTO PRODUCT WARRANTY	GARANTIA FUNDO TÉRMICO THERMAL BOTTOM WARRANTY
	Louça Metálica em Aço Inoxidável - Multidisc Stainless Steel Cookware - Multidisc	10 anos 10 years			Panela de Pressão Startwist Startwist Pressure Cooker	10 anos 10 years	25 anos 25 years
	Louça Metálica em Aço Inoxidável - Impact Disc Plus Stainless Steel Cookware- - Impact Disc Plus	10 anos 10 years	25 anos 25 years		Panela de Pressão Tradicional Inox - Open Control Traditional Stainless Steel- Open Control Pressure Cooker	10 anos 10 years	25 anos 25 years
	Louça Metálica em Aço Inoxidável - Peças Pintadas Stainless Steel Cookware- - Exterior coating	10 anos 10 years	25 anos 25 years		Panela de Pressão Tradicional Inox Traditional Pressure Cooker -Stainless Steel	10 anos 10 years	25 anos 25 years
	Louça Metálica em Aço Inoxidável - Tampa de Vidro Stainless Steel Cookware - Glass Lid	10 anos 10 years	25 anos 25 years		Panela de Pressão Tradicional Inox - Vermelha Red Traditional Pressure Cooker -Stainless Steel	10 anos 10 years	25 anos 25 years
	Louça Metálica em Aço Inoxidável - com Antiaderente Stainless Steel Cookware - with non stick coating	3 anos 3 years	25 anos 25 years		Panela de Pressão Tradicional Alumínio Traditional Pressure Cooker - Aluminium	3 anos 3 years	
	Gama Profissional Horeca Horeca Professional Range	3 anos 3 years	25 anos 25 years		Panela de Pressão Easy Easy Pressure Cooker	3 anos 3 years	25 anos 25 years
	Louça Metálica Alumínio - Venus Aluminium Cookware - Venus	3 anos 3 years					
	Faqueiro Lisbon Lisbon Cutlery Set	3 anos 3 years					

As garantias aplicáveis a outros modelos devem ser consultadas em www.silampos.pt
Warranties applicable to other models should be consulted at www.silampos.pt

* A garantia cobre apenas defeitos de fabrico
The warranty only covers manufacturing defects

LOUÇA DE COZINHA

COOKWARE

A EXPERIÊNCIA CONTA E A QUALIDADE CONVENCE

EXPERIENCE COUNTS
AND QUALITY CONVINCES



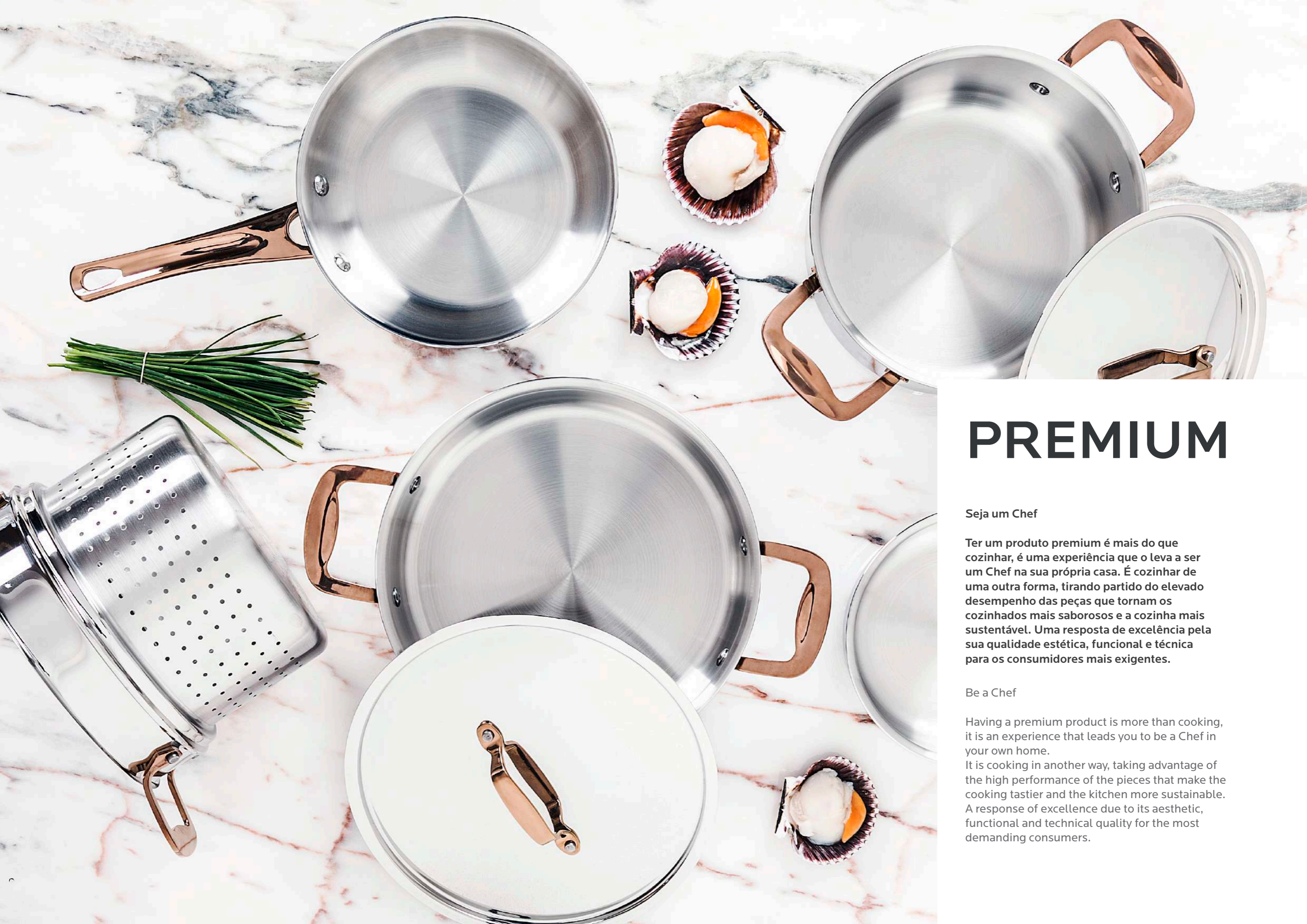

PREMIUM

Seja um Chef

Ter um produto premium é mais do que cozinhar, é uma experiência que o leva a ser um Chef na sua própria casa. É cozinhar de uma outra forma, tirando partido do elevado desempenho das peças que tornam os cozinhados mais saborosos e a cozinha mais sustentável. Uma resposta de excelência pela sua qualidade estética, funcional e técnica para os consumidores mais exigentes.

Be a Chef

Having a premium product is more than cooking, it is an experience that leads you to be a Chef in your own home.

It is cooking in another way, taking advantage of the high performance of the pieces that make the cooking tastier and the kitchen more sustainable. A response of excellence due to its aesthetic, functional and technical quality for the most demanding consumers.

PREMIUM

SUPREME ESSENCE

ELEVADO DESEMPENHO
HIGH PERFORMANCE

MULTIDISC **3** PLY

Este modelo é composto por 3 camadas. A camada exterior, em aço inoxidável, assegura a compatibilidade com todas as fontes de calor, incluindo a indução. A camada intermédia é composta por alumínio puro que liga as outras camadas. Estas asseguram conjuntamente uma excelente condução e distribuição do calor. A última camada interna, em aço inoxidável 18/10 evita a corrosão, estando própria para o contacto com os alimentos. A louça Multidisc substitui o fundo térmico mais sofisticado, uma vez que com a sua utilização já é possível extrapolar para todo o corpo da peça as vantagens do fundo térmico.

As vantagens são inumeráveis. O calor é distribuído uniformemente por toda a peça, minimizando desta forma as diferenças de temperatura entre o fundo e as laterais do corpo. Esta uniformidade na condução e distribuição do calor resulta da combinação das várias camadas. Uma vez quente, não arrefece tão rapidamente quanto a louça de cozinha tradicional. A camada exterior em aço inoxidável previne e retarda a dissipação do calor gerado pela camada intermédia. Por esse motivo, a tecnologia Multidisc permite atingir altas temperaturas e manter os alimentos quentes por mais tempo.

Devido aos níveis superiores de retenção do calor, não necessita de usar a fonte de calor num nível máximo. Pode optar pelo nível médio para cozinhar de forma eficiente em qualquer fonte de calor, poupando assim tempo e energia. A distribuição uniforme do calor facilita a cozedura e evita que os alimentos possam queimar ou agarrar ao fundo. Conseguirá obter os melhores resultados ao cozinhar com pouca água, para preservar os nutrientes e vitaminas dos alimentos.

This model is composed by 3 layers of raw materials. The exterior layer, in stainless steel, makes the piece compatible with all energy sources, including induction. The middle layer is made of pure aluminium which league the other layers. Together, these layers provide excellent heat conduction and distribution. The final inner layer, in 18/10 stainless steel, makes it rust resistant and appropriate for contact with food. Multidisc cookware substitutes the most sophisticated thermal bottom, as its use enables the entire piece to take full advantage of the thermal base benefits.

The advantages are innumerable. The heat is uniformly transferred to the entire piece, minimizing the temperature differences between the bottom and the sides. This uniformity in both the conduction and distribution of heat is the result of the multiple layers which cover the entire piece. Also, once heated, does not cool off as quickly as traditional cookware. The exterior stainless steel layers prevent and slow the dispersion of heat generated by the inner layer. Therefore, Multidisc is able to reach much higher cooking temperatures and keep the food hot much longer.

Because of superior levels of heat retention, it is not necessary to cook at high temperatures. Only a medium temperature is required to cook efficiently on any type of cooker or hot plate, thereby saving significant time and energy. The uniform heat distribution makes cooking easier by preventing food from burning and sticking to the bottom. You will also obtain the best results when cooking without water, preserving the nutrients and vitamins in the food.

Aço inoxidável
Stainless Steel

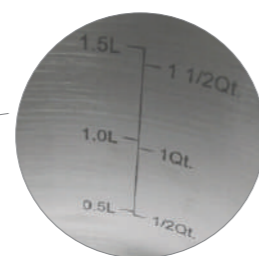

Marcação interior da capacidade.
Inner capacity scale.

Asa com revestimento em titânio PVD
Handle with titanium coating PVD

Polido
Mirror polished

2,3mm
Espessura do corpo e do fundo
Bottom and body thickness



CAÇAROLA BAIXA
LOW CASSEPOLE

Diam.(cm)	Alt.(cm)	Capac.(L)	Artigo
Diam.(cm)	Hgh(cm)	Capac.(L)	Article
Ø24	8.7	2.8	639002GD0924
Ø26	10.6	4.3	639002GD0926



CAÇAROLA ALTA COM CABO
DEEP SAUCEPAN

Diam.(cm)	Alt.(cm)	Capac.(L)	Artigo
Diam.(cm)	Hgh(cm)	Capac.(L)	Article
Ø14	10.8	1.3	639002GD3014*
Ø16	12.1	1.9	639002GD3016*
Ø18	13.6	2.8	639002GD3018*

* Sob consulta/ On request



CAÇAROLA C/ ASAS
CASSEPOLE

Diam.(cm)	Alt.(cm)	Capac.(L)	Artigo
Diam.(cm)	Hgh(cm)	Capac.(L)	Article
Ø16	7.7	1.5	639002GD1016
Ø20	9.7	3.0	639002GD1020
Ø24	12	5.3	639002GD1024



WOK C/ASAS
WOK W/HANDLES

Diam.(cm)	Alt.(cm)	Capac.(L)	Artigo
Diam.(cm)	Hgh(cm)	Capac.(L)	Article
Ø28	11.7	4.2	639002GD8428*

* Sob consulta/ On request

PANELA C/ ASAS
STOCKPOT

Diam.(cm)	Alt.(cm)	Capac.(L)	Artigo
Diam.(cm)	Hgh(cm)	Capac.(L)	Article
Ø16	12.1	1.9	639002GD6616
Ø20	14.7	3.8	639002GD6620
Ø24	17.2	6.6	639002GD6624
Ø26	18.6	8.5	639002GD6626



CAÇAROLA CÓNICA
ANTIADERENTE C/ASAS
NON-STICK CONICAL CASSEPOLE

Diam.(cm)	Alt.(cm)	Capac.(L)	Artigo
Diam.(cm)	Hgh(cm)	Capac.(L)	Article
Ø24	10.9	3.3	63900AGD5924*

* Sob consulta/ On request



CAÇAROLA C/ CABO
SAUCEPAN

Diam.(cm)	Alt.(cm)	Capac.(L)	Artigo
Diam.(cm)	Hgh(cm)	Capac.(L)	Article
Ø16	10	1.5	639002GD1116



CAÇAROLA CÓNICA C/ASAS
CONICAL CASSEPOLE

Diam.(cm)	Alt.(cm)	Capac.(L)	Artigo
Diam.(cm)	Hgh(cm)	Capac.(L)	Article
Ø24	10.9	3.3	639002GD5924*

* Sob consulta/ On request

* Sob consulta/ On request



FRIGIDEIRA CÓNICA ANTIADERENTE
NON-STICK CONICAL FRYPAN

Diam.(cm)	Alt.(cm)	Artigo
Diam.(cm)	Hgh(cm)	Article
Ø20	3.6	63900AGD5620
Ø26	4.7	63900AGD5626
Ø28	5	63900AGD5628



FOOD SAFE
PFDA/TFMP
FREE



FRIGIDEIRA CÓNICA C/ CABO
CONICAL FRYPAN

Diam.(cm)	Alt.(cm)	Artigo
Diam.(cm)	Hgh(cm)	Article
Ø20	3.6	639002GD5620
Ø26	4.7	639002GD5626
Ø28	5	639002GD5628

CONJ. TUTTI-PASTA BAIXO
LOW TUTTI-PASTA SET

Diam.(cm)	Artigo
Diam.(cm)	Article
Ø20	639002GD0201*

* Sob consulta/ On request



CAÇAROLA TRIPLA COZER VAPOR C/ASAS
MULTISTEAMER W/ HANDLES

Diam.(cm)	Alt.(cm)	Artigo
Diam.(cm)	Hgh(cm)	Article
Ø20	9	631002GD1820*

* Sob consulta/ On request



PREMIUM

SUPREME PROF

ELEVADO DESEMPENHO
HIGH PERFORMANCE

MULTIDISC  3 PLY

Este modelo é composto por 3 camadas. A camada exterior, em aço inoxidável, assegura a compatibilidade com todas as fontes de calor, incluindo a indução. A camada intermédia é composta por alumínio puro que liga as outras camadas. Estas asseguram conjuntamente uma excelente condução e distribuição do calor. A última camada interna, em aço inoxidável 18/10 evita a corrosão, estando própria para o contacto com os alimentos. A louça Multidisc substitui o fundo térmico mais sofisticado, uma vez que com a sua utilização já é possível extrapolar para todo o corpo da peça as vantagens do fundo térmico.

As vantagens são inumeráveis. O calor é distribuído uniformemente por toda a peça, minimizando desta forma as diferenças de temperatura entre o fundo e as laterais do corpo. Esta uniformidade na condução e distribuição do calor resulta da combinação das várias camadas. Uma vez quente, não arrefece tão rapidamente quanto a louça de cozinha tradicional. A camada exterior em aço inoxidável previne e retarda a dissipação do calor gerado pela camada intermédia. Por esse motivo, a tecnologia Multidisc permite atingir altas temperaturas e manter os alimentos quentes por mais tempo.

Devido aos níveis superiores de retenção do calor, não necessita de usar a fonte de calor num nível máximo. Pode optar pelo nível médio para cozinhar de forma eficiente em qualquer fonte de calor, poupando assim tempo e energia. A distribuição uniforme do calor facilita a cozedura e evita que os alimentos possam queimar ou agarrar ao fundo. Conseguirá obter os melhores resultados ao cozinhar com pouca água, para preservar os nutrientes e vitaminas dos alimentos.

This model is composed by 3 layers of raw materials. The exterior layer, in stainless steel, makes the piece compatible with all energy sources, including induction. The middle layer is made of pure aluminium which league the other layers. Together, these layers provide excellent heat conduction and distribution. The final inner layer, in 18/10 stainless steel, makes it rust resistant and appropriate for contact with food. Multidisc cookware substitutes the most sophisticated thermal bottom, as its use enables the entire piece to take full advantage of the thermal base benefits.

The advantages are innumerable. The heat is uniformly transferred to the entire piece, minimizing the temperature differences between the bottom and the sides. This uniformity in both the conduction and distribution of heat is the result of the multiple layers which cover the entire piece. Also, once heated, does not cool off as quickly as traditional cookware. The exterior stainless steel layers prevent and slow the dispersion of heat generated by the inner layer. Therefore, Multidisc is able to reach much higher cooking temperatures and keep the food hot much longer.

Because of superior levels of heat retention, it is not necessary to cook at high temperatures. Only a medium temperature is required to cook efficiently on any type of cooker or hot plate, thereby saving significant time and energy. The uniform heat distribution makes cooking easier by preventing food from burning and sticking to the bottom. You will also obtain the best results when cooking without water, preserving the nutrients and vitamins in the food.

Aço inoxidável
Stainless Steel

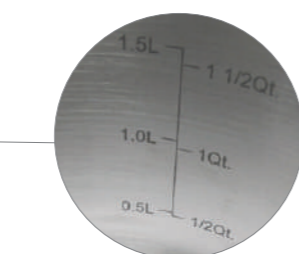

Marcação interior da capacidade.
Inner capacity scale.

Asa de aço inoxidável
Stainless Steel Handle

Polido
Mirror polished

2,3mm
Espessura do corpo e do fundo
Bottom and body thickness



CAÇAROLA BAIXA
LOW CASSEPOLE

Diam.(cm)	Alt.(cm)	Capac.(L)	Artigo
Diam.(cm)	Hgh(cm)	Capac.(L)	Article
Ø24	8.7	2.8	639002BG0924
Ø26	10.6	4.3	639002BG0926



CAÇAROLA ALTA COM CABO
DEEP SAUCEPAN

Diam.(cm)	Alt.(cm)	Capac.(L)	Artigo
Diam.(cm)	Hgh(cm)	Capac.(L)	Article
Ø14	10.8	1.3	639002BG3014
Ø16	12.1	1.9	639002BG3016
Ø18	13.6	2.8	639002BG3018
Ø20	14.7	3.8	639002BG3020



CAÇAROLA C/ ASAS
CASSEPOLE

Diam.(cm)	Alt.(cm)	Capac.(L)	Artigo
Diam.(cm)	Hgh(cm)	Capac.(L)	Article
Ø16	7.7	1.5	639002BG1016
Ø20	9.7	3.0	639002BG1020
Ø24	12	5.3	639002BG1024

WOK C/ASAS
WOK W/HANDLES

Diam.(cm)	Alt.(cm)	Capac.(L)	Artigo
Diam.(cm)	Hgh(cm)	Capac.(L)	Article
Ø28	11.7	4.2	639002BG8428



PANELA C/ ASAS
STOCKPOT

Diam.(cm)	Alt.(cm)	Capac.(L)	Artigo
Diam.(cm)	Hgh(cm)	Capac.(L)	Article
Ø16	12.1	1.9	639002BG6616
Ø18	13.6	2.8	639002BG6618
Ø20	14.7	3.8	639002BG6620
Ø24	17.2	6.6	639002BG6624
Ø26	18.6	8.5	639002BG6626
Ø28	19.5	10.4	639002BG6628



CAÇAROLA CÓNICA
ANTIADERENTE C/ASAS
NON-STICK CONICAL CASSEPOLE

Diam.(cm)	Alt.(cm)	Capac.(L)	Artigo
Diam.(cm)	Hgh(cm)	Capac.(L)	Article
Ø24	10.9	3.3	63900ABG5924



FOOD SAFE
PFOA/NMP
FREE



CAÇAROLA C/ CABO
SAUCEPAN

Diam.(cm)	Alt.(cm)	Capac.(L)	Artigo
Diam.(cm)	Hgh(cm)	Capac.(L)	Article
Ø16	10	1.5	639002BG1116

CAÇAROLA CÓNICA C/ASAS
CONICAL CASSEPOLE

Diam.(cm)	Alt.(cm)	Capac.(L)	Artigo
Diam.(cm)	Hgh(cm)	Capac.(L)	Article
Ø24	10.9	3.3	639002BG5924





FRIGIDEIRA CÓNICA ANTIADERENTE
NON-STICK CONICAL FRYPAN

Diam.(cm)	Alt.(cm)	Artigo
Diam.(cm)	Hgh(cm)	Article
Ø20	3.6	63900ABG5620
Ø26	4.7	63900ABG5626
Ø28	5	63900ABG5628
Ø30	5	63900ABG5630



FOOD SAFE
PFOA/NMP
FREE



FRIGIDEIRA CÓNICA C/ CABO
CONICAL FRYPAN

Diam.(cm)	Alt.(cm)	Artigo
Diam.(cm)	Hgh(cm)	Article
Ø20	3.6	639002BG5620
Ø26	4.7	639002BG5626
Ø28	5	639002BG5628
Ø30	5	639002BG5630

CONJ. TUTTI-PASTA BAIXO
LOW TUTTI-PASTA SET

Diam.(cm)	Artigo
Diam.(cm)	Article
Ø20	639002BG0201



CAÇAROLA TRIPLA COZER VAPOR C/ASAS
MULTISTEAMER W/ HANDLES

Diam.(cm)	Alt.(cm)	Artigo
Diam.(cm)	Hgh(cm)	Article
Ø20	9	631002BG1820





SELECTION

Uma seleção de produtos que se distinguem pelo seu design e qualidade. Apresentam características estéticas e de desempenho para brilhar na sua cozinha e mesa. Receba os seus convidados e sirva a refeição numa peça Selection. Ninguém vai ficar indiferente.

A selection of products distinguished by their design and quality. We present aesthetic and performance characteristics to shine in your kitchen and table. Receive your guests and serve the meal in a Selection cookware. Nobody will remain indifferent.

SELECTION

HERITAGE

NOVO
NEW

RETRO REVIVAL

IMPACT DISC PLUS

Um modelo com um design vintage mas com a sua essência renovada. O Heritage faz-nos reviver uma cozinha com peças clássicas.

A model with a vintage design but with its renewed essence. Heritage makes us relive a kitchen with classic pieces.

Acessórios dourados com revestimento em titânio PVD
Golden accessories with titanium coating PVD



Aço inoxidável
Stainless Steel

Revestimento exterior de cor verde
Green coloured exterior coating

6mm
Espessura do fundo
Bottom thickness

PANELA C/ASAS
STOCKPOT

Diam.(cm)	Altura(cm)	Capac.(L)	Artigo
Diam.(cm)	Height(cm)	Capac.(L)	Article
Ø16	11.5	2.2	63212MGO6616
Ø20	13.6	4	63212MGO6620
Ø24	15.6	6.7	63212MGO6624

CAÇAROLA C/ASAS
CASSEROLE

Diam.(cm)	Altura(cm)	Capac.(L)	Artigo
Diam.(cm)	Height(cm)	Capac.(L)	Article
Ø16	8	1.5	63212MGO1016
Ø20	9.1	2.6	63212MGO1020
Ø24	10.1	4.2	63212MGO1024

CAÇAROLA C/CABO
SAUCEPAN

Diam.(cm)	Altura(cm)	Capac.(L)	Artigo
Diam.(cm)	Height(cm)	Capac.(L)	Article
Ø16	8	1.5	63212MGO1116

FRIGIDEIRA CÓNICA ANTIADERENTE
NON-STICK CONICAL FRYPAN

Diam.(cm)	Altura(cm)	Capac.(L)	Artigo
Diam.(cm)	Height(cm)	Capac.(L)	Article
Ø20	3.6	1	63C12NGO5620
Ø24	4.9	1.7	63C12NGO5624



FOOD
SAFE
PFOA/NMP
FREE

SELECTION

COMFORT

CONFORTO TOTAL
TOTAL COMFORT

IMPACT DISC PLUS

Asa Tubular
Tubular handlePolido
PolishedAço inoxidável
Stainless Steel6mm
Espessura do fundo
Bottom thickness

As asas mantêm um nível de temperatura confortável para assegurar um manuseamento mais prático e seguro.
The handles maintain a comfortable temperature level to ensure a more practical and safe handling.

CONJUNTO 9 PEÇAS (FRIG. ANTIADERENTE)
9 PIECES SET (FRYPAN NON-STICK)Artigo
Article
632122FT0188Outros composições de conjuntos possíveis sob consulta.
Other set compositions availableCAÇAROLA C/ASAS
CASSEROLE

Diam.(cm)	Altura(cm)	Capac.(L)	Artigo
Diam.(cm)	Height(cm)	Capac.(L)	Article
Ø16	8	1.5	632122FT1016
Ø18	8.6	2	632122FT1018*
Ø20	9.1	2.6	632122FT1020
Ø22	9.6	3.2	632122FT1022*
Ø24	10.1	4.2	632122FT1024
Ø26	10.6	5.2	632122FT1026*
Ø28	11.2	6.7	632122FT1028*

CAÇAROLA BAIXA
LOW CASSEROLE

Diam.(cm)	Altura(cm)	Capac.(L)	Artigo
Diam.(cm)	Height(cm)	Capac.(L)	Article
Ø26	7.1	3.4	632122FT0926*

CAÇAROLA C/CABO
SAUCEPAN

Diam.(cm)	Altura(cm)	Capac.(L)	Artigo
Diam.(cm)	Height(cm)	Capac.(L)	Article
Ø14	7.5	1.1	632122FT1114*
Ø16	8	1.5	632122FT1116
Ø18	8.6	2	632122FT1118*
Ø20	9.1	2.6	632122FT1120*

PANELA C/ASAS
STOCKPOT

Diam.(cm)	Altura(cm)	Capac.(L)	Artigo
Diam.(cm)	Height(cm)	Capac.(L)	Article
Ø16	11.5	2.2	632122FT6616
Ø18	12.6	3	632122FT6618*
Ø20	13.6	4	632122FT6620
Ø22	14.6	5	632122FT6622*
Ø24	15.6	6.7	632122FT6624
Ø26	16.6	8.3	632122FT6626*
Ø28	17.7	10.3	632122FT6628*

* Sob consulta/ On request





**FOOD
SAFE**
PFOA/NMP
FREE

**FRIGIDEIRA CÓNICA
ANTIADERENTE C/CABO
NON-STICK CONICAL FRYPAN**

Diam.(cm)	Altura(cm)	Capac.(L)	Artigo
Diam.(cm)	Height(cm)	Capac.(L)	Article
Ø20	4.4	1	63C12AFT5620*
Ø24	4.9	1.7	63C12AFT5624
Ø26	5	2	63C12AFT5626*
Ø28	5	2.3	63C12AFT5628*

**CAÇAROLA COZER A VAPOR
STEAMER**

Diam.(cm)	Altura(cm)	Capac.(L)	Artigo
Diam.(cm)	Height(cm)	Capac.(L)	Article
Ø20	8.4		631002FT1420



**CAFETEIRA C/ASA
MILK POT**

Diam.(cm)	Altura(cm)	Capac.(L)	Artigo
Diam.(cm)	Height(cm)	Capac.(L)	Article
Ø14	13	1.9	632122FT2214



**ESPARGUETEIRA
PASTA POT**

Diam.(cm)	Altura(cm)	Capac.(L)	Artigo
Diam.(cm)	Height(cm)	Capac.(L)	Article
Ø20	14.5		631002FT3720



SELECTION

COMFORT GLASS

NOVO
NEW

CONFORTO TOTAL
TOTAL COMFORT

IMPACT DISC PLUS



As asas mantêm um nível de temperatura confortável para assegurar um manuseamento mais prático e seguro. The handles maintain a comfortable temperature level to ensure a more practical and safe handling.



CAÇAROLA C/ASAS
CASSEROLE

Diam.(cm)	Altura(cm)	Capac.(L)	Artigo
Diam.(cm)	Height(cm)	Capac.(L)	Article
Ø16	8	1.5	632122WR1016
Ø18	8.6	2	632122WR1018*
Ø20	9.1	2.6	632122WR1020
Ø22	9.6	3.2	632122WR1022*
Ø24	10.1	4.2	632122WR1024
Ø26	10.6	5.2	632122WR1026*
Ø28	11.2	6.7	632122WR1028*



PANELA C/ASAS
STOCKPOT

Diam.(cm)	Altura(cm)	Capac.(L)	Artigo
Diam.(cm)	Height(cm)	Capac.(L)	Article
Ø16	11.5	2.2	632122WR6616
Ø18	12.6	3	632122WR6618*
Ø20	13.6	4	632122WR6620
Ø22	14.6	5	632122WR6622*
Ø24	15.6	6.7	632122WR6624
Ø26	16.6	8.3	632122WR6626*
Ø28	17.7	10.3	632122WR6628*



CAÇAROLA BAIXA
LOW CASSEROLE

Diam.(cm)	Altura(cm)	Capac.(L)	Artigo
Diam.(cm)	Height(cm)	Capac.(L)	Article
Ø26	7.1	3.4	632122WR0926*



CAFETEIRA C/ASA
MILK POT

Diam.(cm)	Altura(cm)	Capac.(L)	Artigo
Diam.(cm)	Height(cm)	Capac.(L)	Article
Ø14	13	1.9	632122WR2214



CONJUNTO 9 PEÇAS (FRIG. ANTIADERENTE)
9 PIECES SET (FRYPAN NON-STICK)

Artigo
Article
632122WR0188

Outros composições de conjuntos possíveis sob consulta.
Other set compositions available



CAÇAROLA C/CABO
SAUCEPAN

Diam.(cm)	Altura(cm)	Capac.(L)	Artigo
Diam.(cm)	Height(cm)	Capac.(L)	Article
Ø14	7.5	1.1	632122WR1114*
Ø16	8	1.5	632122WR1116
Ø18	8.6	2	632122WR1118*
Ø20	9.1	2.6	632122WR1120*

* Sob consulta/ On request



FRIGIDEIRA CÓNICA
ANTIADERENTE C/CABO
NON-STICK CONICAL FRYPAN

Diam.(cm)	Altura(cm)	Capac.(L)	Artigo
Diam.(cm)	Height(cm)	Capac.(L)	Article
Ø20	4.4	1	63C12AFT5620*
Ø24	4.9	1.7	63C12AFT5624
Ø26	5	2	63C12AFT5626*
Ø28	5	2.3	63C12AFT5628*



FOOD SAFE
PFOA/PFOS
FREE

SELECTION

COMFORT GLASS BLACK

NOVO
NEW

IMPACT DISC PLUS

CONFORTO TOTAL
TOTAL COMFORT5mm
Espessura tampa de vidro
Glass Lid thicknessAsa Tubular
Tubular handle

As asas mantêm um nível de temperatura confortável para assegurar um manuseamento mais prático e seguro.

The handles maintain a comfortable temperature level to ensure a more practical and safe handling.

Aço inoxidável
Stainless SteelRevestimento exterior de cor preto
Black coloured exterior coating6mm
Espessura do fundo
Bottom thicknessCAÇAROLA C/ASAS
CASSEROLE

Diam.(cm)	Altura(cm)	Capac.(L)	Artigo
Diam.(cm)	Height(cm)	Capac.(L)	Article
Ø16	8	1.5	63212JWR1016
Ø20	9.1	2.6	63212JWR1020
Ø24	10.1	4.2	63212JWR1024

PANELA C/ASAS
STOCKPOT

Diam.(cm)	Altura(cm)	Capac.(L)	Artigo
Diam.(cm)	Height(cm)	Capac.(L)	Article
Ø16	11.5	2.2	63212JWR6616
Ø20	13.6	4	63212JWR6620
Ø24	15.6	6.7	63212JWR6624

CAÇAROLA C/CABO
SAUCEPAN

Diam.(cm)	Altura(cm)	Capac.(L)	Artigo
Diam.(cm)	Height(cm)	Capac.(L)	Article
Ø16	8	1.5	63212JWR1116

FOOD
SAFE
PFOA/NMP
FREEFRIGIDEIRA CÓNICA
ANTIADERENTE C/CABO
NON-STICK CONICAL FRYPAN

Diam.(cm)	Altura(cm)	Capac.(L)	Artigo
Diam.(cm)	Height(cm)	Capac.(L)	Article
Ø24	4.9	1.7	63C12KFT5624

SELECTION

COMFORT GLASS BEGE

CONFORTO TOTAL
TOTAL COMFORT

IMPACT DISC PLUS

Asa Tubular
Tubular handle

5mm
Espessura tampa de vidro
Glass Lid thickness

Aço inoxidável
Stainless Steel

Revestimento
exterior de cor bege
Beige coloured
exterior coating

6mm
Espessura do fundo
Bottom thickness



As asas mantêm um nível de temperatura confortável para assegurar um manuseamento mais prático e seguro.

The handles maintain a comfortable temperature level to ensure a more practical and safe handling.

ESCOLHA A SUA COR SELECT YOUR OWN COLOR

Sugestão de cores
Colour suggestions



CHOCOLATE



LIGHT YELLOW

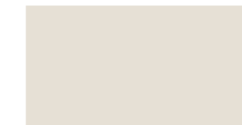

FLORAL WHITE



OLIVE DRAB



STEELBLUE



*CAÇAROLA C/ASAS
CASSEROLE

*PANELA C/ASAS
STOCKPOT

*CAÇAROLA C/CABO
SAUCEPAN

*Outras cores disponíveis sob consulta
Other colours are available upon request

SELECTION

YUMI

BELEZA QUE PERDURA
AS BEAUTIFUL AS EVER

IMPACT DISC PLUS

SEJA ESPECIAL

Design elegante. Tampa de encaixe para evitar o deslizamento, com a percepção estética de uma tampa de pousar. Acessórios com um único ponto por onde se transmite o calor. Aço inox 18/10. Fundo térmico ID Plus.

BE SPECIAL

Elegant design. It has an unusual fitting lid, which avoids its sliding, with the perceived look of a rest lid. Its accessories have one heat-transmission point only and a handle wide enough to quickly disperse high temperatures.



Asa de varão
Wire handle

Polido
Mirror polished

Aço inoxidável
Stainless Steel

6mm
Espessura do fundo
Bottom thickness

FRIGIDEIRA CÔNICA C/ ASAS ANTIADERENTE
NON-STICK CONICAL FRYPAN W/HANDLES

Diam.(cm)	Alt.(cm)	Capac.(L)	Artigo
Diam.(cm)	Hgh(cm)	Capac.(L)	Article
Ø26	5	2	63212AAC5926A

PANELA C/ ASAS
STOCKPOT

Diam.(cm)	Alt.(cm)	Capac.(L)	Artigo
Diam.(cm)	Hgh(cm)	Capac.(L)	Article
Ø16	11	2.4	636122AC6616
Ø18	12.2	3.3	636122AC6618
Ø20	13.1	4.4	636122AC6620
Ø24	14.9	7.1	636122AC6624
Ø28	17.2	11.1	636122AC6628

CAÇAROLA C/ ASAS
CASSEROLE

Diam.(cm)	Alt.(cm)	Capac.(L)	Artigo
Diam.(cm)	Hgh(cm)	Capac.(L)	Article
Ø16	8.1	1.6	636122AC1016
Ø20	9.2	2.6	636122AC1020
Ø24	10.2	4.6	636122AC1024
Ø28	11.3	6.8	636122AC1028

CONJUNTO 9 PEÇAS (FRIG. ANTIADERENTE)
9 PIECES SET (FRYPAN NON-STICK)

Artigo
Article
636122AC0183

Outros composições de conjuntos possíveis sob consulta.
Other set compositions available

CAÇAROLA C/ CABO
SAUCEPAN

Diam.(cm)	Alt.(cm)	Capac.(L)	Artigo
Diam.(cm)	Hgh(cm)	Capac.(L)	Article
Ø16	8.1	1.6	636122AC1116
Ø20	9.2	2.6	636122AC1120

CAFETEIRA C/ ASA
MILK POT

Diam.(cm)	Alt.(cm)	Capac.(L)	Artigo
Diam.(cm)	Hgh(cm)	Capac.(L)	Article
Ø14	12.5	2.1	636122AC2214

SELECTION

YUMI GLASS

BELEZA QUE PERDURA
AS BEAUTIFUL AS EVER

IMPACT DISC PLUS

SEJA ESPECIAL

Design elegante. Tampa de encaixe para evitar o deslizamento, com a percepção estética de uma tampa de pousar. Acessórios com um único ponto por onde se transmite o calor. Aço inox 18/10. Fundo térmico ID Plus.

BE SPECIAL

Elegant design. It has an unusual fitting lid, which avoids its sliding, with the perceived look of a rest lid. Its accessories have one heat-transmission point only and a handle wide enough to quickly disperse high temperatures.



PANELA COM ASAS STOCKPOT

Diam.(cm)	Alt.(cm)	Capac.(L)	Artigo
Diam.(cm)	Hgh(cm)	Capac.(L)	Article
Ø16	11	2.4	636122VJ6616
Ø20	13.1	4.4	636122VJ6620
Ø24	14.9	7.1	636122VJ6624
Ø28	17.2	11.1	636122VJ6628



CAÇAROLA C/ ASAS CASSEROLE

Diam.(cm)	Alt.(cm)	Capac.(L)	Artigo
Diam.(cm)	Hgh(cm)	Capac.(L)	Article
Ø16	8.1	1.6	636122VJ1016
Ø20	9.2	2.6	636122VJ1020
Ø24	10.2	4.6	636122VJ1024
Ø28	11.3	6.8	636122VJ1028

FRIGIDEIRA CÔNICA C/ ASAS E TAMPA ANTIADERENTE NON-STICK CONICAL FRYPAN W/HANDLES AND LID

Diam.(cm)	Alt.(cm)	Capac.(L)	Artigo
Diam.(cm)	Hgh(cm)	Capac.(L)	Article
Ø26	5	2	63212AVJ5926A



FOOD
SAFE
FFDA/NSF
FREE



CONJUNTO 9 PEÇAS (FRIG. ANTIADERENTE) 9 PIECES SET (FRYPAN NON-STICK)

Artigo
Article
636122VJ0183

Outros composições de conjuntos possíveis sob consulta.
Other set compositions available



CAÇAROLA C/ CABO SAUCEPAN

Diam.(cm)	Alt.(cm)	Capac.(L)	Artigo
Diam.(cm)	Hgh(cm)	Capac.(L)	Article
Ø16	8.1	1.6	636122VJ1116
Ø20	9.2	2.6	636122VJ1120



CAFETEIRA C/ ASA MILK POT

Diam.(cm)	Alt.(cm)	Capac.(L)	Artigo
Diam.(cm)	Hgh(cm)	Capac.(L)	Article
Ø14	12.5	2.1	636122VJ2214

SELECTION

ATLÂNTICO GLASS

ESPREITE OS SEUS COZINHADOS
SNEAK A PEEK AT YOUR COOKINGS

IMPACT DISC PLUS



CONJUNTO 9 PEÇAS (FRIG. ANTIADERENTE) 9 PIECES SET (FRYPAN NON-STICK)

Artigo
Article
632125V50188

Outros composições de conjuntos possíveis sob consulta.
Other set compositions available



FRIGIDEIRA CÓNICA ANTIADERENTE C/CABO NON-STICK CONICAL FRYPAN

Diam.(cm) Diam.(cm)	Altura(cm) Height(cm)	Capac.(L) Capac.(L)	Artigo Article
Ø20	4.4	1	63212CCJ5620
Ø24	4.9	1.7	63212CCJ5624
Ø26	5	2	63212CCJ5626
Ø28	5	2.3	63212CCJ5628



CAÇAROLA C/ASAS C/ TAMPA DE VIDRO CASSEROLE W/ GLASS LID

Diam.(cm) Diam.(cm)	Altura(cm) Height(cm)	Capac.(L) Capac.(L)	Artigo Article
Ø16	8	1.5	632125V51016
Ø18	8.6	2	632125V51018
Ø20	9.1	2.6	632125V51020
Ø22	9.6	3.4	632125V51022
Ø24	10.1	4.2	632125V51024
Ø26	10.6	5.2	632125V51026
Ø28	11.2	6.7	632125V51028



PANELA C/ASAS C/ TAMPA DE VIDRO STOCKPOT W/ GLASS LID

Diam.(cm) Diam.(cm)	Altura(cm) Height(cm)	Capac.(L) Capac.(L)	Artigo Article
Ø16	11.5	2.2	632125V56616
Ø18	12.6	3	632125V56618
Ø20	13.6	4	632125V56620
Ø22	14.6	5.2	632125V56622
Ø24	15.6	6.7	632125V56624
Ø26	16.6	8.3	632125V56626
Ø28	17.7	10.3	632125V56628



CAÇAROLA C/CABO C/ TAMPA DE VIDRO SAUCEPAN W/ GLASS LID

Diam.(cm) Diam.(cm)	Altura(cm) Height(cm)	Capac.(L) Capac.(L)	Artigo Article
Ø14	7.5	1.1	632125V51114
Ø16	8	1.5	632125V51116
Ø18	8.6	2	632125V51118
Ø20	9.1	2.6	632125V51120



CAFETEIRA C/ASA C/ TAMPA DE VIDRO MILK POT W/ GLASS LID

Diam.(cm) Diam.(cm)	Altura(cm) Height(cm)	Capac.(L) Capac.(L)	Artigo Article
Ø14	13	1.9	632125V52214

SELECTION

NAUTILUS

MAR DE SABORES
SEA OF FLAVOURS

IMPACT DISC PLUS



Asa de varão
Wire handle



¹ Polido
Mirror
polished

² Satinado
Satin

Aço inoxidável
Stainless Steel

6mm
Espessura do fundo
Bottom thickness



CONJUNTO 9 PEÇAS (FRIG. ANTIADERENTE)
9 PIECES SET (FRYPAN NON-STICK)

Artigo
Article
632125590188

Outros composições de conjuntos possíveis sob consulta.
Other set compositions available



CAÇAROLA C/ ASAS
CASSEROLE

Diam.(cm)	Alt.(cm)	Capac.(L)	Artigo
Diam.(cm)	Hgh(cm)	Capac.(L)	Article
Ø14	7.5	1.1	632125591014
Ø16	8	1.5	632125591016
Ø18	8.6	2	632125591018
Ø20	9.1	2.6	632125591020
Ø22	9.6	3.4	632125591022
Ø24	10.1	4.2	632125591024
Ø26	10.6	5.2	632125591026
Ø28	11.2	6.7	632125591028
Ø30	11.7	7.6	632125591030
Ø32	12.2	9	632125591032



CAÇAROLA BAIXA C/ ASAS
LOW CASSEPOLE

Diam.(cm)	Alt.(cm)	Capac.(L)	Artigo
Diam.(cm)	Hgh(cm)	Capac.(L)	Article
Ø24	7.1	2.9	632125590924
Ø28	7.7	4.3	632125590928
Ø32	7.7	5.3	632125590932



FOOD SAFE
PFOA/PFHP
FREE

FRIGIDEIRA CÔNICA ANTIADERENTE
NON-STICK CONICAL FRYPAN

Diam.(cm)	Alt.(cm)	Capac.(L)	Artigo
Diam.(cm)	Hgh(cm)	Capac.(L)	Article
Ø20	4.4	1	63212C595620
Ø24	4.9	1.7	63212C595624
Ø26	5	2	63212C595626
Ø28	5	2.3	63212C595628



FRIGIDEIRA C/ CABO
FRYPAN

Diam.(cm)	Alt.(cm)	Capac.(L)	Artigo
Diam.(cm)	Hgh(cm)	Capac.(L)	Article
Ø20	5.3	1.4	632125595120
Ø24	5.6	2.1	632125595124
Ø26	5.6	2.5	632125595126
Ø28	6.1	3.2	632125595128



FRIGIDEIRA CÔNICA C/ CABO
CONICAL FRYPAN

Diam.(cm)	Alt.(cm)	Capac.(L)	Artigo
Diam.(cm)	Hgh(cm)	Capac.(L)	Article
Ø20	4.4	1	632125595620
Ø24	4.5	1.7	632125595624
Ø26	5	2	632125595626
Ø28	5	2.3	632125595628





CAFETEIRA C/ ASA
MILK POT

Diam.(cm)	Alt.(cm)	Capac.(L)	Artigo
Diam.(cm)	Hgh(cm)	Capac.(L)	Article
Ø14	13	1.9	632125592214



CAÇAROLA C/ CABO
SAUCEPAN

Diam.(cm)	Alt.(cm)	Capac.(L)	Artigo
Diam.(cm)	Hgh(cm)	Capac.(L)	Article
Ø14	7.5	1.1	632125591114
Ø16	8	1.5	632125591116
Ø18	8.6	2	632125591118
Ø20	9.1	2.6	632125591120



PANELA ALTA C/ ASAS
DEEP STOCKPOT

Diam.(cm)	Alt.(cm)	Capac.(L)	Artigo
Diam.(cm)	Hgh(cm)	Capac.(L)	Article
Ø20	21.1	6.3	632125596520
Ø24	22.6	9.8	632125596524



PANELA C/ ASAS
STOCKPOT

Diam.(cm)	Alt.(cm)	Capac.(L)	Artigo
Diam.(cm)	Hgh(cm)	Capac.(L)	Article
Ø14	10.5	1.5	632125596614
Ø16	11.5	2.2	632125596616
Ø18	12.6	3	632125596618
Ø20	13.6	4	632125596620
Ø22	14.6	5.2	632125596622
Ø24	15.6	6.7	632125596624
Ø26	16.6	8.3	632125596626
Ø28	17.7	10.3	632125596628
Ø30	18.7	12.6	632125596630
Ø32	19.7	14.9	632125596632



SELECTION

NAUTILUS GLASS

MAR DE SABORES
SEA OF FLAVOURS

IMPACT DISC PLUS



CAÇAROLA C/ ASAS
CASSEROLE

Diam.(cm)	Alt.(cm)	Capac.(L)	Artigo
Diam.(cm)	Hgh(cm)	Capac.(L)	Article
Ø16	8	1.5	632125VE1016
Ø18	8.6	2	632125VE1018
Ø20	9.1	2.6	632125VE1020
Ø22	9.6	3.4	632125VE1022
Ø24	10.1	4.2	632125VE1024
Ø26	10.6	5.2	632125VE1026
Ø28	11.2	6.7	632125VE1028



CAÇAROLA C/ CABO
SAUCEPAN

Diam.(cm)	Alt.(cm)	Capac.(L)	Artigo
Diam.(cm)	Hgh(cm)	Capac.(L)	Article
Ø14	7.5	1.1	632125VE1114
Ø16	8	1.5	632125VE1116
Ø18	8.6	2	632125VE1118
Ø20	9.1	2.6	632125VE1120

FRIGIDEIRA C/ CABO
FRYPAN

Diam.(cm)	Alt.(cm)	Capac.(L)	Artigo
Diam.(cm)	Hgh(cm)	Capac.(L)	Article
Ø20	5.3	1.4	632125595120
Ø24	5.6	2.1	632125595124
Ø26	5.6	2.5	632125595126
Ø28	6.1	3.2	632125595128



CONJUNTO 9 PEÇAS (FRIG. ANTIADERENTE)
9 PIECES SET (FRYPAN NON-STICK)

Artigo
Article
632125VE0188

Outros composições de conjuntos possíveis sob consulta.
Other set compositions available

FRIGIDEIRA CÓNICA C/ CABO
CONICAL FRYPAN

Diam.(cm)	Alt.(cm)	Capac.(L)	Artigo
Diam.(cm)	Hgh(cm)	Capac.(L)	Article
Ø20	4.4	1	632125595620
Ø24	4.5	1.7	632125595624
Ø26	5	2	632125595626
Ø28	5	2.3	632125595628





PANELA C/ ASAS
STOCKPOT

Diam.(cm)	Alt.(cm)	Capac.(L)	Artigo
Diam.(cm)	Hgh(cm)	Capac.(L)	Article
Ø16	11.5	2.2	632125VE6616
Ø18	12.6	3	632125VE6618
Ø20	13.6	4	632125VE6620
Ø22	14.6	5.2	632125VE6622
Ø24	15.6	6.7	632125VE6624
Ø26	16.6	8.3	632125VE6626
Ø28	17.7	10.3	632125VE6628



CAÇAROLA BAIXA C/ ASAS
LOW CASSEROLE

Diam.(cm)	Alt.(cm)	Capac.(L)	Artigo
Diam.(cm)	Hgh(cm)	Capac.(L)	Article
Ø26	7.1	3.4	632125VE0926



CAFETEIRA C/ ASA
MILK POT

Diam.(cm)	Alt.(cm)	Capac.(L)	Artigo
Diam.(cm)	Hgh(cm)	Capac.(L)	Article
Ø14	13	1.9	632125VE2214



FOOD
SAFE
PFOS/PHP
FREE



FRIGIDEIRA CÓNICA ANTIADERENTE
NON-STICK CONICAL FRYPAN

Diam.(cm)	Alt.(cm)	Capac.(L)	Artigo
Diam.(cm)	Hgh(cm)	Capac.(L)	Article
Ø20	4.4	1	63212C595620
Ø24	4.9	1.7	63212C595624
Ø26	5	2	63212C595626
Ø28	5	2.3	63212C595628



SELECTION

OCEANUS SATIN GLASS

INFLUÊNCIA DO OCEANO
OCEAN SPIRIT

IMPACT DISC PLUS



FRIGIDEIRA CÔNICA ANTIADERENTE
NON-STICK CONICAL FRYPAN

Diam.(cm)	Alt.(cm)	Capac.(L)	Artigo
Diam.(cm)	Hgh(cm)	Capac.(L)	Article
Ø20	4.4	1	63212ECV5620
Ø24	4.9	1.7	63212ECV5624
Ø26	5	2	63212ECV5626
Ø28	5	2.3	63212ECV5628



FOOD SAFE
PFOS/PFOA FREE



ÇAÇAROLA C/ CABO C/ TAMPA DE VIDRO
SAUCEPAN W/ GLASS LID

Diam.(cm)	Alt.(cm)	Capac.(L)	Artigo
Diam.(cm)	Hgh(cm)	Capac.(L)	Article
Ø16	8.1	1.6	636124V81116



CAFETEIRA C/ ASA C/ TAMPA DE VIDRO
MILK POT W/GLASS LID

Diam.(cm)	Alt.(cm)	Capac.(L)	Artigo
Diam.(cm)	Hgh(cm)	Capac.(L)	Article
Ø14	12.5	2.1	636124V82214



CONJUNTO 9 PEÇAS (FRIG. ANTIADERENTE)
9 PIECES SET (FRY PAN NON-STICK)

Artigo
Article
636124V80188

Outros composições de conjuntos possíveis sob consulta.
Other set compositions available



PANELA C/ ASAS C/ TAMPA DE VIDRO
STOCKPOT W/ GLASS LID

Diam.(cm)	Alt.(cm)	Capac.(L)	Artigo
Diam.(cm)	Hgh(cm)	Capac.(L)	Article
Ø16	11	2.4	636124V86616
Ø20	13.1	4.4	636124V86620
Ø24	14.9	7.1	636124V86624
Ø28	17.2	11.1	636124V86628



ÇAÇAROLA C/ ASAS C/ TAMPA DE VIDRO
CASSEROLE W/ GLASS LID

Diam.(cm)	Alt.(cm)	Capac.(L)	Artigo
Diam.(cm)	Hgh(cm)	Capac.(L)	Article
Ø16	8.1	1.6	636124V81016
Ø20	9.2	2.6	636124V81020
Ø24	10.2	4.6	636124V81024
Ø28	11.3	6.8	636124V81028

SELECTION

PROFISSIONAL TEJO 2000

CHEF DA CASA
HOME CHEF

IMPACT DISC PLUS

Disponível apenas para mercado externo
Only available for international market



CONJUNTO 9 PEÇAS 9 PIECES SET

Artigo
Article
632125640083

Outros composições de conjuntos possíveis sob consulta.
Other set compositions available



PANELA C/ ASAS STOCKPOT

Diam.(cm)	Alt.(cm)	Capac.(L)	Artigo
Diam.(cm)	Hgh(cm)	Capac.(L)	Article
Ø14	10.5	1.5	632125646614
Ø16	11.5	2.2	632125646616
Ø18	12.6	3	632125646618
Ø20	13.6	4	632125646620
Ø22	14.6	5.2	632125646622
Ø24	15.6	6.7	632125646624
Ø26	16.6	8.3	632125646626
Ø28	17.7	10.3	632125646628
Ø30	18.7	12.6	632125646630
Ø32	19.7	14.9	632125646632



CAÇAROLA C/ ASAS CASSEROLE

Diam.(cm)	Alt.(cm)	Capac.(L)	Artigo
Diam.(cm)	Hgh(cm)	Capac.(L)	Article
Ø14	7.5	1.1	632125641014
Ø16	8	1.5	632125641016
Ø18	8.6	2	632125641018
Ø20	9.1	2.6	632125641020
Ø22	9.6	3.4	632125641022
Ø24	10.1	4.2	632125641024
Ø26	10.6	5.2	632125641026
Ø28	11.2	6.7	632125641028
Ø30	11.7	7.6	632125641030
Ø32	12.2	9	632125641032



CAÇAROLA BAIXA C/ ASAS LOW CASSEROLE

Diam.(cm)	Alt.(cm)	Capac.(L)	Artigo
Diam.(cm)	Hgh(cm)	Capac.(L)	Article
Ø24	7.1	2.9	632125640924
Ø28	7.7	4.3	632125640928
Ø32	7.7	5.3	632125640932



PANELA ALTA C/ ASAS DEEP STOCKPOT

Diam.(cm)	Alt.(cm)	Capac.(L)	Artigo
Diam.(cm)	Hgh(cm)	Capac.(L)	Article
Ø20	21.1	6.3	632125646520
Ø24	22.6	9.8	632125646524



CAÇAROLA C/ CABO
SAUCEPAN

Diam.(cm)	Alt.(cm)	Capac.(L)	Artigo
Diam.(cm)	Hgh(cm)	Capac.(L)	Article
Ø14	7.5	1.1	632125641114
Ø16	8	1.5	632125641116
Ø18	8.6	2	632125641118
Ø20	9.1	2.6	632125641120



FOOD
SAFE
PFOA/NPF
FREE



FRIGIDEIRA CÓNICA ANTIADERENTE
NON-STICK CONICAL FRYPAN

Diam.(cm)	Alt.(cm)	Capac.(L)	Artigo
Diam.(cm)	Hgh(cm)	Capac.(L)	Article
Ø20	4.4	1	63212C645620
Ø24	4.9	1.7	63212C645624
Ø26	5	2	63212C645626
Ø28	5	2.3	63212C645628



FRIGIDEIRA C/ CABO
FRYPAN

Diam.(cm)	Alt.(cm)	Capac.(L)	Artigo
Diam.(cm)	Hgh(cm)	Capac.(L)	Article
Ø20	5.3	1.4	632125645120
Ø24	5.6	2.1	632125645124
Ø26	5.6	2.5	632125645126



CAFETEIRA C/ ASA
MILK POT

Diam.(cm)	Alt.(cm)	Capac.(L)	Artigo
Diam.(cm)	Hgh(cm)	Capac.(L)	Article
Ø14	13	1.9	632125642214



SELECTION

PROFISSIONAL TEJO

CHEF DA CASA
HOME CHEF

IMPACT DISC PLUS



Asa de varão
Wire handle

¹ Polido
Mirror
polished

² Satinado
Satin

Aço inoxidável
Stainless Steel

6mm
Espessura do fundo
Bottom thickness



CONJUNTO 9 PEÇAS (FRIG. ANTIADERENTE) 9 PIECES SET (FRYPAN NON-STICK)

Artigo
Article
632123630188

Outros composições de conjuntos possíveis sob consulta.
Other set compositions available



FRIGIDEIRA CÓNICA ANTIADERENTE NON-STICK CONICAL FRYPAN

Diam.(cm)	Alt.(cm)	Capac.(L)	Artigo
Diam.(cm)	Hgh(cm)	Capac.(L)	Article
Ø20	4.4	1	63212B635620
Ø24	4.9	1.7	63212B635624
Ø26	5	2	63212B635626
Ø28	5	2.3	63212B635628



CAFETEIRA C/ ASA MILK POT

Diam.(cm)	Alt.(cm)	Capac.(L)	Artigo
Diam.(cm)	Hgh(cm)	Capac.(L)	Article
Ø14	13	1.9	632123632214



CAÇAROLA C/ ASAS CASSEROLE

Diam.(cm)	Alt.(cm)	Capac.(L)	Artigo
Diam.(cm)	Hgh(cm)	Capac.(L)	Article
Ø14	7.5	1.1	632123631014
Ø16	8	1.5	632123631016
Ø18	8.6	2	632123631018
Ø20	9.1	2.6	632123631020
Ø22	9.6	3.4	632123631022
Ø24	10.1	4.2	632123631024
Ø26	10.6	5.2	632123631026
Ø28	11.2	6.7	632123631028
Ø30	11.7	7.6	632123631030
Ø32	12.2	9	632123631032



CAÇAROLA BAIXA LOW CASSEROLE

Diam.(cm)	Alt.(cm)	Capac.(L)	Artigo
Diam.(cm)	Hgh(cm)	Capac.(L)	Article
Ø24	7.1	2.9	632123630924
Ø28	7.7	4.3	632123630928
Ø32	7.7	5.3	632123630932



CAÇAROLA C/ CABO
SAUCEPAN

Diam.(cm)	Alt.(cm)	Capac.(L)	Artigo
Diam.(cm)	Hgh(cm)	Capac.(L)	Article
Ø14	7.5	1.1	632123631114
Ø16	8	1.5	632123631116
Ø18	8.6	2	632123631118
Ø20	9.1	2.6	632123631120



PANELA C/ ASAS
STOCKPOT

Diam.(cm)	Alt.(cm)	Capac.(L)	Artigo
Diam.(cm)	Hgh(cm)	Capac.(L)	Article
Ø14	10.5	1.5	632123636614
Ø16	11.5	2.2	632123636616
Ø18	12.6	3	632123636618
Ø20	13.6	4	632123636620
Ø22	14.6	5.2	632123636622
Ø24	15.6	6.7	632123636624
Ø26	16.6	8.3	632123636626
Ø28	17.7	10.3	632123636628
Ø30	18.7	12.6	632123636630
Ø32	19.7	14.9	632123636632



PANELA ALTA C/ ASAS
DEEP STOCKPOT

Diam.(cm)	Alt.(cm)	Capac.(L)	Artigo
Diam.(cm)	Hgh(cm)	Capac.(L)	Article
Ø20	21.1	6.3	632123636520
Ø24	22.6	9.8	632123636524



FRIGIDEIRA C/CABO
FRYPAN

Diam.(cm)	Alt.(cm)	Capac.(L)	Artigo
Diam.(cm)	Hgh(cm)	Capac.(L)	Article
Ø20	5.3	1.4	632123635120
Ø24	5.6	2.1	632123635124
Ø26	5.6	2.5	632123635126





TRADITION

Tradicional é intemporal. Modelos com um design clássico que perdura no tempo e brilha em qualquer cozinha. Produtos com uma excelente relação de design, qualidade e preço.

Traditional is timeless. Models with a classic design that lasts through time and shines in any kitchen. Products with an excellent design, quality and price ratio.

TRADITION

DOMUS

INSPIRADO NA TRADIÇÃO
INSPIRED ON TRADITION

IMPACT DISC PLUS

Asa tubular
Tubular handleAço inoxidável
Stainless SteelPolido
Mirror polished6mm
Espessura do fundo
Bottom thicknessCONJUNTO 9 PEÇAS (FRIG. ANTIADERENTE)
9 PIECES SET (FRYPAN NON-STICK)Artigo
Article
633122300188Outros composições de conjuntos possíveis sob consulta.
Other set compositions availableCAÇAROLA C/ASAS
CASSEROLE

Diam.(cm)	Alt.(cm)	Capac.(L)	Artigo
Diam.(cm)	Hgh(cm)	Capac.(L)	Article
Ø14	7.7	1.1	633122301014
Ø16	8.3	1.6	633122301016
Ø18	8.9	2.2	633122301018
Ø20	9.3	2.8	633122301020
Ø22	9.8	3.5	633122301022
Ø24	10.4	4.4	633122301024
Ø26	10.6	5.5	633122301026
Ø28	11.4	6.7	633122301028
Ø32	12.4	9.4	633122301032

CAÇAROLA C/CABO
SAUCEPAN

Diam.(cm)	Alt.(cm)	Capac.(L)	Artigo
Diam.(cm)	Hgh(cm)	Capac.(L)	Article
Ø14	7.7	1.1	633122301114
Ø16	8.3	1.6	633122301116
Ø18	8.9	2.2	633122301118
Ø20	9.3	2.8	633122301120

FRIGIDEIRA C/CABO
FRYPAN

Diam.(cm)	Alt.(cm)	Capac.(L)	Artigo
Diam.(cm)	Hgh(cm)	Capac.(L)	Article
Ø20	5.5	1.5	633122305120
Ø24	5.5	2.2	633122305124
Ø26	6	2.8	633122305126

PANELA C/ASAS
STOCKPOT

Diam.(cm)	Alt.(cm)	Capac.(L)	Artigo
Diam.(cm)	Hgh(cm)	Capac.(L)	Article
Ø16	11.2	2.3	633122306616
Ø18	12.1	3.1	633122306618
Ø20	13.1	4.1	633122306620
Ø22	14.1	5	633122306622
Ø24	15.1	6.4	633122306624
Ø26	16.1	8.4	633122306626
Ø28	17	10.8	633122306628
Ø32	18.9	15.2	633122306632

CAFETEIRA C/ASA
MILK POT

Diam.(cm)	Alt.(cm)	Capac.(L)	Artigo
Diam.(cm)	Hgh(cm)	Capac.(L)	Article
Ø14	15.5	2	633122302214

TRADITION

EUROPA

PERDURA NO TEMPO
LASTS FOREVER

IMPACT DISC PLUS



Polido
Mirror polished

Asa tubular
Tubular handle

Aço inoxidável
Stainless Steel

6mm
Espessura do fundo
Bottom thickness



CAÇAROLA C/ASAS
CASSEROLE

Diam.(cm)	Alt.(cm)	Capac.(L)	Artigo
Diam.(cm)	Hgh(cm)	Capac.(L)	Article
Ø14	7.5	1.1	632122321014
Ø16	8	1.5	632122321016
Ø18	8.6	2	632122321018
Ø20	9.1	2.6	632122321020
Ø22	9.6	3.4	632122321022
Ø24	10.1	4.2	632122321024
Ø26	10.6	5.2	632122321026
Ø28	11.2	6.7	632122321028
Ø30	11.7	7.6	632122321030
Ø32	12.2	9	632122321032



PANELA C/ASAS
STOCKPOT

Diam.(cm)	Alt.(cm)	Capac.(L)	Artigo
Diam.(cm)	Hgh(cm)	Capac.(L)	Article
Ø14	10.5	1.5	632122326614
Ø16	11.5	2.2	632122326616
Ø18	12.6	3	632122326618
Ø20	13.6	4	632122326620
Ø22	14.6	5.2	632122326622
Ø24	15.6	6.7	632122326624
Ø26	16.6	8.3	632122326626
Ø28	17.7	10.3	632122326628
Ø30	18.7	12.6	632122326630
Ø32	19.7	14.9	632122326632



CAÇAROLA C/ASAS
CASSEROLE

Diam.(cm)	Alt.(cm)	Capac.(L)	Artigo
Diam.(cm)	Hgh(cm)	Capac.(L)	Article
Ø12	7	0.6	632122321012



CONJUNTO 9 PEÇAS (FRIG. ANTIADERENTE)
9 PIECES SET (FRYPAN NON-STICK)

Artigo
Article
632122320188

Outros composições de conjuntos possíveis sob consulta.
Other set compositions available



CAÇAROLA BAIXA
LOW CASSEROLE

Diam.(cm)	Alt.(cm)	Capac.(L)	Artigo
Diam.(cm)	Hgh(cm)	Capac.(L)	Article
Ø24	7.1	2.9	632122320924
Ø28	7.7	4.3	632122320928
Ø32	7.7	5.3	632122320932



PANELA ALTA C/ASAS
DEEP STOCKPOT

Diam.(cm)	Alt.(cm)	Capac.(L)	Artigo
Diam.(cm)	Hgh(cm)	Capac.(L)	Article
Ø20	21.1	6.3	632122326520
Ø24	22.6	9.8	632122326524



CAÇAROLA C/CABO
SAUCEPAN

Diam.(cm)	Alt.(cm)	Capac.(L)	Artigo
Diam.(cm)	Hgh(cm)	Capac.(L)	Article
Ø14	7.5	1.1	632122321114
Ø16	8	1.5	632122321116
Ø18	8.6	2	632122321118
Ø20	9.1	2.6	632122321120



CAÇAROLA ALTA 2 BICOS C/CABO
SAUCEPAN W/ 2 LIPS

Diam.(cm)	Alt.(cm)	Capac.(L)	Artigo
Diam.(cm)	Hgh(cm)	Capac.(L)	Article
Ø16	7.5	1.9	632122VM3016B



CAÇAROLA C/CABO
SAUCEPAN

Diam.(cm)	Alt.(cm)	Capac.(L)	Artigo
Diam.(cm)	Hgh(cm)	Capac.(L)	Article
Ø12	6.5	0.6	632122321112



CAFETEIRA C/ ASA SEM TAMPA
MILK POT NO LID

Diam.(cm)	Alt.(cm)	Capac.(L)	Artigo
Diam.(cm)	Hgh(cm)	Capac.(L)	Article
Ø12	11.5	1.2	632122322212A

CAFETEIRA C/ASA
MILK POT

Diam.(cm)	Alt.(cm)	Capac.(L)	Artigo
Diam.(cm)	Hgh(cm)	Capac.(L)	Article
Ø12	13	1.2	632122322212



CAFETEIRA C/ASA
MILK POT

Diam.(cm)	Alt.(cm)	Capac.(L)	Artigo
Diam.(cm)	Hgh(cm)	Capac.(L)	Article
Ø14	13	1.9	632122322214



CANECA
POT

Diam.(cm)	Alt.(cm)	Capac.(L)	Artigo
Diam.(cm)	Hgh(cm)	Capac.(L)	Article
Ø10	10	0.8	631002322410



FRIGIDEIRA C/CABO
FRYPAN

Diam.(cm)	Alt.(cm)	Capac.(L)	Artigo
Diam.(cm)	Hgh(cm)	Capac.(L)	Article
Ø20	5.3	1.4	632122325120
Ø24	5.6	2.1	632122325124
Ø26	5.6	2.5	632122325126



FRIGIDEIRA C/CABO E ASA
FRYING PAN W/HELPER HANDLE

Diam.(cm)	Alt.(cm)	Capac.(L)	Artigo
Diam.(cm)	Hgh(cm)	Capac.(L)	Article
Ø26	5.6	2.5	632122325226



FRIGIDEIRA CÓNICA
ANTIADERENTE DAILY
DAILY NON-STICK CONICAL FRYPAN

Diam.(cm)	Alt.(cm)	Capac.(L)	Artigo
Diam.(cm)	Hgh(cm)	Capac.(L)	Article
Ø20	4.4	1	63C122GK5620V
Ø24	4.9	1.7	63C122GK5624V
Ø26	5	2	63C122GK5626V
Ø28	5	2.3	63C122GK5628V



FOOD
SAFE
PPGA/NMP
FREE



ESCALFADOR OVOS
EGG POACHER

Diam.(cm)	Alt.(cm)	Capac.(L)	Artigo
Diam.(cm)	Hgh(cm)	Capac.(L)	Article
Ø20	2.2	0	631002VB3120



BASIC

Uma ideia simples para a sua casa.

Reduzimos tudo ao básico, mantendo a qualidade, para satisfazer a sua necessidade de cozinhar, e assim poder poupar. Produtos funcionais que facilitam o dia a dia na cozinha a um preço acessível.

A simple idea for your home.

We reduce everything to the basics, maintaining the quality, to satisfy your need to cook, and thus to save. Functional products that make everyday life easier in the kitchen at an affordable price.

BASIC

LOW COST ESSENTIAL

PERFEITO PARA O DIA A DIA
PERFECT FOR DAILY USE

IMPACT DISC PLUS

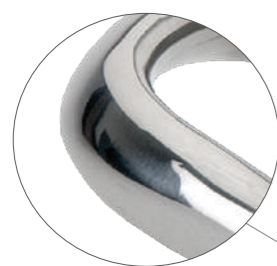

Asa tubular
Tubular handle



Polido
Mirror polished

Aço inoxidável
Stainless Steel

4,7mm
Espessura do fundo
Bottom thickness



CONJUNTO 9 PEÇAS 9 PIECES SET

Artigo
Article
63C122E00086

Outros composições de conjuntos possíveis sob consulta.
Other set compositions available

FRIGIDEIRA CÓNICA ANTIADERENTE DAILY DAILY NON-STICK CONICAL FRYPAN

Diam.(cm)	Alt.(cm)	Capac.(L)	Artigo
Diam.(cm)	Hgh(cm)	Capac.(L)	Article
Ø20	4.4	1	63C122GK5620V
Ø24	4.9	1.7	63C122GK5624V
Ø26	5	2	63C122GK5626V
Ø28	5	2.3	63C122GK5628V



FOOD
SAFE
PFOA/NP
FREE



CAÇAROLA C/ASAS CASSEROLE

Diam.(cm)	Alt.(cm)	Capac.(L)	Artigo
Diam.(cm)	Hgh(cm)	Capac.(L)	Article
Ø16	7.9	1.5	63C122E01016
Ø18	8.4	2	63C122E01018
Ø20	9	2.6	63C122E01020
Ø22	9.6	3.4	63C122E01022
Ø24	10	4.2	63C122E01024
Ø26	10.5	5.2	63C122E01026
Ø28	11	6.7	63C122E01028
Ø32	12.2	9	63C122E01032



PANELA C/ASAS STOCKPOT

Diam.(cm)	Alt.(cm)	Capac.(L)	Artigo
Diam.(cm)	Hgh(cm)	Capac.(L)	Article
Ø16	11.4	2.2	63C122E06616
Ø18	12.6	3	63C122E06618
Ø20	13.5	4	63C122E06620
Ø22	14.6	5.2	63C122E06622
Ø24	15.5	6.7	63C122E06624
Ø26	16.5	8.3	63C122E06626
Ø28	17.5	10.3	63C122E06628
Ø32	19.7	14.9	63C122E06632



CAÇAROLA C/CABO SAUCEPAN

Diam.(cm)	Alt.(cm)	Capac.(L)	Artigo
Diam.(cm)	Hgh(cm)	Capac.(L)	Article
Ø14	7.5	1.1	63C122E01114
Ø16	7.9	1.5	63C122E01116
Ø18	8.6	2	63C122E01118
Ø20	9.1	2.6	63C122E01120



CAFETEIRA C/ASA MILK POT

Diam.(cm)	Alt.(cm)	Capac.(L)	Artigo
Diam.(cm)	Hgh(cm)	Capac.(L)	Article
Ø14	12.9	1.9	63C122E02214

BASIC

LOW COST ESSENTIAL GLASS

PERFEITO PARA O DIA A DIA
PERFECT FOR DAILY USE

IMPACT DISC PLUS



5mm
Espessura tampa de vidro
Glass lid thickness

Aço inoxidável
Stainless Steel

Polido
Mirror polished

4,7mm
Espessura do fundo
Bottom thickness



CAÇAROLA C/ASAS CASSEROLE

Diam.(cm)	Alt.(cm)	Capac.(L)	Artigo
Diam.(cm)	Hgh(cm)	Capac.(L)	Article
Ø16	8	1.5	63C122WG1016
Ø18	8.4	2	63C122WG1018
Ø20	9.1	2.6	63C122WG1020
Ø22	9.6	3.4	63C122WG1022
Ø24	10.1	4.2	63C122WG1024
Ø26	10.6	5.2	63C122WG1026
Ø28	11	6.7	63C122WG1028



PANELA C/ASAS STOCKPOT

Diam.(cm)	Alt.(cm)	Capac.(L)	Artigo
Diam.(cm)	Hgh(cm)	Capac.(L)	Article
Ø16	11.4	2.2	63C122WG6616
Ø18	12.6	3	63C122WG6618
Ø20	13.5	4	63C122WG6620
Ø22	14.6	5.2	63C122WG6622
Ø24	15.6	6.7	63C122WG6624
Ø26	16.6	8.3	63C122WG6626
Ø28	17.7	10.3	63C122WG6628



CAÇAROLA C/CABO SAUCEPAN

Diam.(cm)	Alt.(cm)	Capac.(L)	Artigo
Diam.(cm)	Hgh(cm)	Capac.(L)	Article
Ø14	7.5	1.1	63C122WG1114
Ø16	8.1	1.5	63C122WG1116
Ø18	8.6	2	63C122WG1118
Ø20	8.6	2.6	63C122WG1120



CAFETEIRA C/ASA MILK POT

Diam.(cm)	Alt.(cm)	Capac.(L)	Artigo
Diam.(cm)	Hgh(cm)	Capac.(L)	Article
Ø14	13	1.9	63C122WG2214



CONJUNTO 9 PEÇAS 9 PIECES SET

Artigo
Article
63C122WG0086

Outros composições de conjuntos possíveis sob consulta.
Other set compositions available

FRIGIDEIRA CÔNICA ANTIADERENTE DAILY DAILY NON-STICK CONICAL FRYPAN

Diam.(cm)	Alt.(cm)	Capac.(L)	Artigo
Diam.(cm)	Hgh(cm)	Capac.(L)	Article
Ø20	4.4	1	63C122GK5620V
Ø24	4.9	1.7	63C122GK5624V
Ø26	5	2	63C122GK5626V
Ø28	5	2.3	63C122GK5628V



FOOD
SAFE
PFOA/NMP
FREE

BASIC

LOW COST CLASSIC

PERFEITO PARA O DIA A DIA
PERFECT FOR DAILY USE

IMPACT DISC PLUS



Asa tubular
Tubular handle

Aço inoxidável
Stainless Steel

Polido
Mirror polished

4,7mm
Espessura do fundo
Bottom thickness



PANELA C/ASAS
STOCKPOT

Diam.(cm)	Alt.(cm)	Capac.(L)	Artigo
Diam.(cm)	Hgh(cm)	Capac.(L)	Article
Ø16	11.1	2.2	637122CP6616L
Ø18	11.5	3	637122CP6618L
Ø20	13.1	4	637122CP6620L
Ø22	14	5.2	637122CP6622L
Ø24	15.1	6.7	637122CP6624L
Ø26	16.1	8.4	637122CP6626L
Ø28	17	10.3	637122CP6628L
Ø32	18.2	15	637122CP6632L



CAÇAROLA C/ASAS
CASSEROLE

Diam.(cm)	Alt.(cm)	Capac.(L)	Artigo
Diam.(cm)	Hgh(cm)	Capac.(L)	Article
Ø16	8.1	1.6	637122CP1016L
Ø18	8.5	2.1	637122CP1018L
Ø20	9	2.7	637122CP1020L
Ø22	9.6	3.5	637122CP1022L
Ø24	10.1	4.4	637122CP1024L
Ø26	10.6	5.5	637122CP1026L
Ø28	11.0	6.6	637122CP1028L
Ø32	11.7	9.7	637122CP1032L



CAÇAROLA C/CABO
SAUCEPAN

Diam.(cm)	Alt.(cm)	Capac.(L)	Artigo
Diam.(cm)	Hgh(cm)	Capac.(L)	Article
Ø14	7.5	1.1	637122CP1114L
Ø16	8.1	1.6	637122CP1116L
Ø18	8.5	2.1	637122CP1118L
Ø20	8.5	2.7	637122CP1120L



CAFETEIRA C/ASA
MILK POT

Diam.(cm)	Alt.(cm)	Capac.(L)	Artigo
Diam.(cm)	Hgh(cm)	Capac.(L)	Article
Ø14	12.4	1.9	637122CP2214L



CONJUNTO 9 PEÇAS
9 PIECES SET

Artigo
Article
637122CP0086

Outros composições de conjuntos possíveis sob consulta.
Other set compositions available

FRIGIDEIRA CÔNICA ANTIADERENTE DAILY
DAILY NON-STICK CONICAL FRYPAN

Diam.(cm)	Alt.(cm)	Capac.(L)	Artigo
Diam.(cm)	Hgh(cm)	Capac.(L)	Article
Ø20	4.4	1	63C122GK5620V
Ø24	4.9	1.7	63C122GK5624V
Ø26	5	2	63C122GK5626V
Ø28	5	2.3	63C122GK5628V



FOOD SAFE
PFOA/NMP FREE

BASIC

LOW COST CLASSIC GLASS

PERFEITO PARA O DIA A DIA
PERFECT FOR DAILY USE

IMPACT DISC PLUS



Aço inoxidável
Stainless Steel

Polido
Mirror polished

4,7mm
Espessura do fundo
Bottom thickness



CONJUNTO 9 PEÇAS 9 PIECES SET

Artigo
Article
637122V70188L

Outros composições de conjuntos possíveis sob consulta.
Other set compositions available



PANELA C/ASAS STOCKPOT

Diam.(cm)	Alt.(cm)	Capac.(L)	Artigo
Diam.(cm)	Hgh(cm)	Capac.(L)	Article
Ø16	11.1	2.2	637122V76616L
Ø20	13.1	4	637122V76620L
Ø22	14	5.2	637122V76622L
Ø24	15.1	6.7	637122V76624L
Ø26	16.1	8.4	637122V76626L
Ø28	17	10.3	637122V76628L



CAÇAROLA C/ASAS CASSEROLE

Diam.(cm)	Alt.(cm)	Capac.(L)	Artigo
Diam.(cm)	Hgh(cm)	Capac.(L)	Article
Ø16	8.1	1.6	637122V71016L
Ø18	8.5	2.1	637122V71018L
Ø20	9	2.7	637122V71020L
Ø22	9.6	3.5	637122V71022L
Ø24	10.1	4.4	637122V71024L
Ø26	10.6	5.5	637122V71026L
Ø28	11	6.6	637122V71028L



CAÇAROLA C/CABO SAUCEPAN

Diam.(cm)	Alt.(cm)	Capac.(L)	Artigo
Diam.(cm)	Hgh(cm)	Capac.(L)	Article
Ø14	7	1.1	637122V71114L
Ø16	8.1	1.6	637122V71116L
Ø18	8.5	2.1	637122V71118L
Ø20	8.5	2.7	637122V71120L



CAFETEIRA C/ASA MILK POT

Diam.(cm)	Alt.(cm)	Capac.(L)	Artigo
Diam.(cm)	Hgh(cm)	Capac.(L)	Article
Ø14	12.4	1.9	637122V72214L

FRIGIDEIRA CÓNICA ANTIADERENTE DAILY DAILY NON-STICK CONICAL FRYPAN

Diam.(cm)	Alt.(cm)	Capac.(L)	Artigo
Diam.(cm)	Hgh(cm)	Capac.(L)	Article
Ø20	4.4	1	63C122GK5620V
Ø24	4.9	1.7	63C122GK5624V
Ø26	5	2	63C122GK5626V
Ø28	5	2.3	63C122GK5628V



FOOD
SAFE
PFOS/PFOA
FREE



HORECA

GRAND HOTEL

GRANDES MEDIDAS. GRANDES MOMENTOS.
GREAT MEASURES. GREAT MOMENTS.

IMPACT DISC PLUS

Esta gama foi concebida para responder às necessidades dos grandes chefs de cozinha, que necessitam de uma linha diversificada, robusta e que apresenta várias medidas disponíveis. O GrandHotel marca a diferença pelo seu design atual e por um acabamento satinado do aço inoxidável que facilita a limpeza das peças.

GrandHotel range has been designed to meet the needs of the great chefs who need a diversified, robust cookware with several measures available. GrandHotel makes a difference for its design and for its satin finish stainless steel that facilitates cleaning.



Asa varão
Wire handle

Aço inoxidável
Stainless Steel

Satinado
Satin

6mm
Espessura do fundo
Bottom thickness



CAÇAROLA CÓNICA C/ CABO
CONICAL SAUCEPAN

Diam.(cm)	Altura(cm)	Capac.(L)	Artigo
Diam.(cm)	Height(cm)	Capac.(L)	Article
Ø20	7.5	2.1	638121BB0320A *
Ø24	8	3.3	638121BB0324A *

CAÇAROLA BAIXA
LOW CASSEPOLE

Diam.(cm)	Alt.(cm)	Capac.(L)	Artigo
Diam.(cm)	Hgh(cm)	Capac.(L)	Article
Ø24	6.1	2.5	638121BB0924 *
Ø28	6.1	3.5	638121BB0928 *
Ø32	6.2	4.6	638121BB0932 *
Ø36	7.5	6.8	638221BB0936
Ø40	8.5	9.6	638221BB0940



CAÇAROLA C/ASAS
CASSEPOLE

Diam.(cm)	Alt.(cm)	Capac.(L)	Artigo
Diam.(cm)	Hgh(cm)	Capac.(L)	Article
Ø16	8	1.5	638121BB1016 *
Ø20	9.1	2.6	638121BB1020 *
Ø24	10.1	4.1	638121BB1024 *
Ø28	11.7	6.7	638121BB1028 *
Ø32	13.2	9.8	638121BB1032 *
Ø36	14	13.4	638221BB1036
Ø40	15.5	18.3	638221BB1040

CAÇAROLA ALTA C/ASAS
DEEP CASSEPOLE

Diam.(cm)	Alt.(cm)	Capac.(L)	Artigo
Diam.(cm)	Hgh(cm)	Capac.(L)	Article
Ø16	11.5	2.2	638121BB2916 *
Ø20	13.6	4	638121BB2920 *
Ø24	15.6	6.5	638121BB2924 *
Ø28	17.7	10.3	638121BB2928 *
Ø32	18.7	14.1	638121BB2932 *
Ø36	22	21.4	638221BB2936
Ø40	25	30.5	638221BB2940
Ø45	28	44	638221BB2945
Ø50	32	62	638221BB2950
Ø60	35	96	638221BB2960



*Fundo Impact Disc Plus Impact Disc Plus bottom

TECNOLOGIA
IMPACT DISC PLUS

FRIGIDEIRA CÓNICA ANTIADERENTE
NON-STICK CONICAL FRYPAN

Diam.(cm)	Altura(cm)	Capac.(L)	Artigo
Diam.(cm)	Height(cm)	Capac.(L)	Article
Ø24	4.5	1.7	63812EBB5624*
Ø28	5	2.3	63812EBB5628*



FOOD SAFE
PFOA/NMP
FREE

TECNOLOGIA TECHNOLOGY
MULTIDISC 3 PLY

FRIGIDEIRA COM CABO MULTILAYER
MULTILAYER FRYING PAN

Diam.(cm)	Alt.(cm)	Artigo
Diam.(cm)	Hgh(cm)	Article
Ø24	5.2	639002BB5624
Ø26	4.9	639002BB5626
Ø28	6.2	639002BB5628
Ø30	5	639002BB5630
Ø32	6.7	639002BB5632



FRIGIDEIRA C/CABO
FRYPAN

Diam.(cm)	Altura(cm)	Capac.(L)	Artigo
Diam.(cm)	Height(cm)	Capac.(L)	Article
Ø24	6.1	2.5	638121BB5124*
Ø28	6.1	3.5	638121BB5128*



FRIGIDEIRA COM CABO
ANTIADERENTE MULTILAYER
MULTILAYER NON-STICK
FRYPAN

Diam.(cm)	Alt.(cm)	Artigo
Diam.(cm)	Hgh(cm)	Article
Ø24	5.2	63900ABB5624
Ø26	4.9	63900ABB5626
Ø28	6.2	63900ABB5628
Ø30	5	63900ABB5630
Ø32	6.7	63900ABB5632

TECNOLOGIA TECHNOLOGY
MULTIDISC 3 PLY



FOOD SAFE
PFOA/NMP
FREE

FRIGIDEIRA C/ CABO E ASA
FRYPAN W/HELPER HANDLE

Diam.(cm)	Alt.(cm)	Capac.(L)	Artigo
Diam.(cm)	Hgh(cm)	Capac.(L)	Article
Ø32	6.2	4.6	638121BB5232*
Ø36	7.5	6.8	638221BB5236
Ø40	8.5	9.6	638221BB5240



*Fundo Impact Disc Plus Impact Disc Plus bottom





BANHO-MARIA COM CABO
BOILER W/LONG HANDLE

Diam.(cm)	Altura(cm)	Capac.(L)	Artigo
Diam.(cm)	Height(cm)	Capac.(L)	Article
Ø16	16	3.2	638121BB6716A *
Ø20	20	6.3	638121BB6720A *

PANELA C/ ASAS
STOCKPOT

Diam.(cm)	Altura(cm)	Capac.(L)	Artigo
Diam.(cm)	Height(cm)	Capac.(L)	Article
Ø16	16.5	3.2	638121BB6616 *
Ø20	20.6	6.3	638121BB6620 *
Ø24	24.6	10.6	638121BB6624 *
Ø28	28.5	17	638221BB6628 *
Ø32	32.5	25.4	638221BB6632 *
Ø36	36.5	36	638221BB6636 *
Ø40	40.5	49.6	638221BB6640 *
Ø45	45	71	638221BB6645 *
Ø50	50	78	638221BB6650 *
Ø60	55	150	638221BB6660 *



CAÇAROLA ALTA C/ CABO
DEEP SAUCEPAN

Diam.(cm)	Altura(cm)	Capac.(L)	Artigo
Diam.(cm)	Height(cm)	Capac.(L)	Article
Ø16	11.6	2.2	638121BB3016A *
Ø20	13.6	4	638121BB3020A *
Ø24	15.6	6.5	638121BB3024A *
Ø28	17.7	10.3	638121BB3028A *



CAÇAROLA C/ CABO
SAUCEPAN

Diam.(cm)	Alt.(cm)	Capac.(L)	Artigo
Diam.(cm)	Hgh(cm)	Capac.(L)	Article
Ø16	8	1.5	638121BB1116A *
Ø20	9.1	2.6	638121BB1120A *
Ø24	10.1	4.1	638121BB1124A *
Ø28	11.7	6.7	638121BB1128A *



TABULEIRO C/ASAS 50X36X6cm
PROFESSIONAL ROASTER 50X36X6cm

Alt.(cm)	Artigo
Hgh(cm)	Article
6.1	631008BB7810

TABULEIRO C/ASAS 53X40X4cm
PROFESSIONAL ROASTER 53X40X4cm

Alt.(cm)	Artigo
Hgh(cm)	Article
4.1	631008BB7815

TABULEIRO C/ASAS 60X40X6cm
PROFESSIONAL ROASTER 60X40X6cm

Alt.(cm)	Artigo
Hgh(cm)	Article
6.1	631008BB7825



TERRINA - GrandHotel
SOUP TUREEN- GrandHotel

Diam.(cm)	Alt.(cm)	Capac.(L)	Artigo
Diam.(cm)	Hgh(cm)	Capac.(L)	Article
Ø26	14	5	631001BB8326



TERRINA 26 S/ TAMPA - GrandHotel
SOUP TUREEN 26 NO LID - GrandHotel

Diam.(cm)	Alt.(cm)	Capac.(L)	Artigo
Diam.(cm)	Hgh(cm)	Capac.(L)	Article
Ø26	14	5	631001BB8326A



TERRINA 26 S/ TAMPA - Europa
SOUP TUREEN 26 NO LID - Europa

Diam.(cm)	Alt.(cm)	Capac.(L)	Artigo
Diam.(cm)	Hgh(cm)	Capac.(L)	Article
Ø26	14	5	631002328326A



TERRINA 26 - Europa
SOUP TUREEN - Europa

Diam.(cm)	Alt.(cm)	Capac.(L)	Artigo
Diam.(cm)	Hgh(cm)	Capac.(L)	Article
Ø26	14	5	631002948326

TAMPA
LID

Diam.(cm)	Alt.(cm)	Artigo
Diam.(cm)	Hgh(cm)	Article
Ø16	0.9	638007BB7916
Ø20	1.5	638007BB7920
Ø24	1.6	638007BB7924
Ø28	2.1	638007BB7928
Ø32	1.6	638007BB7932
Ø36	2.1	638007BB7936
Ø40	2.6	638007BB7940
Ø45	3	638007BB7945
Ø50	3.8	638007BB7950
Ø60	3.8	638007BB7960



FAÇA O SEU CONJUNTO MAKE YOUR OWN SET

Os conjuntos variam de 3 a 9 elementos.
Sets between 3 and 9.

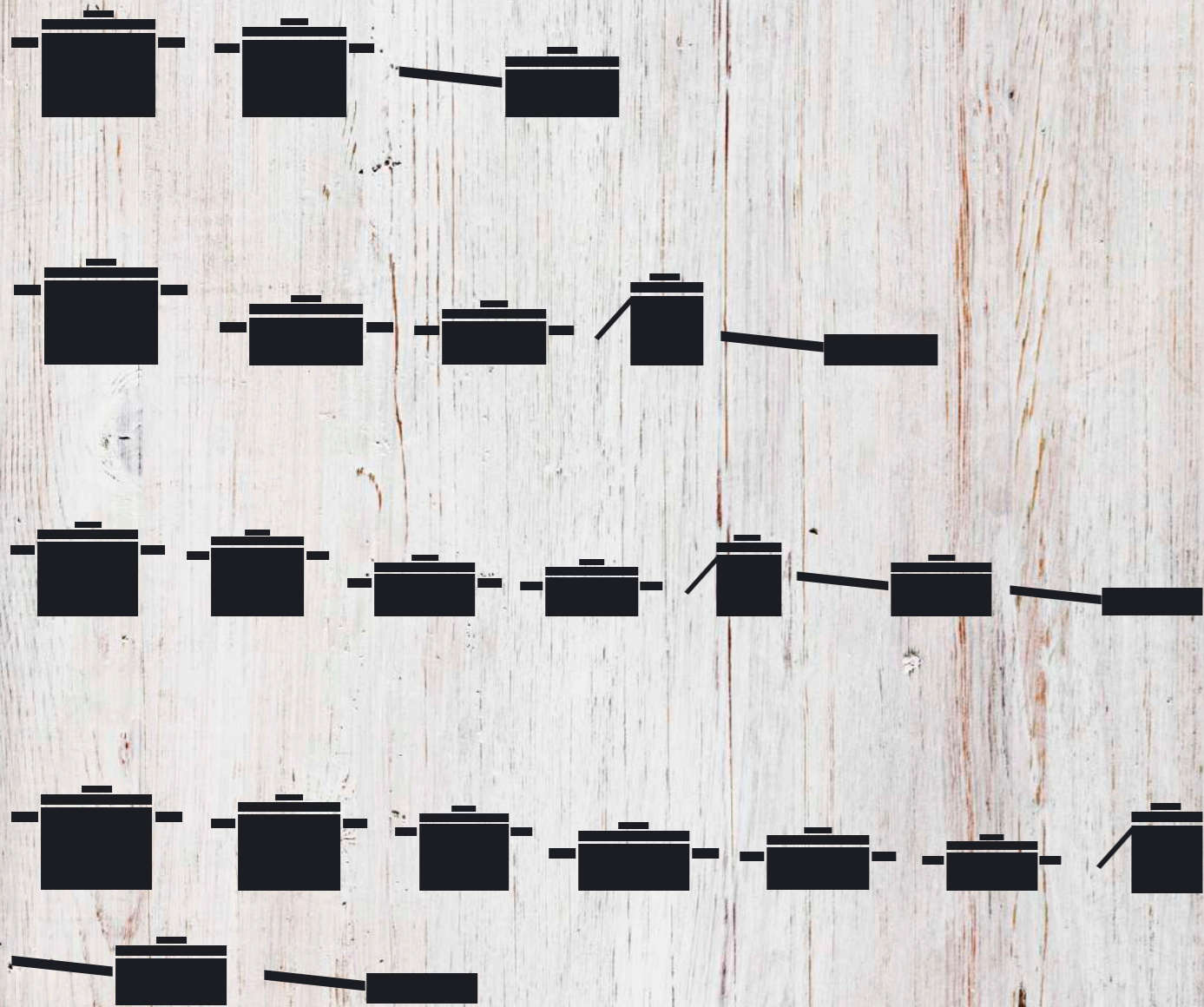

*Outros composições de conjuntos possíveis sob consulta.
Other set compositions available.

CAIXAS PACKAGING

- 1 CAIXA CONJUNTO 5 PEÇAS 5 PIECES BOX SET
- 2 CAIXA INDIVIDUAL CRAFT CRAFT INDIVIDUAL BOX
- 3 CAIXA CONJUNTO BOX SET
- 4 CAIXA CONJUNTO 9 PEÇAS 9 PIECES BOX SET



KIT EMBALAGEM BOX KIT

MANGAS DE FRIGIDEIRAS COOKWARE SLEEVES



RÓTULO AUTOCOLANTE
STICKER LABEL



MARCAÇÃO DE FUNDO LASER
LASER BOTTOM STENCIL

COMPATIBILIDADE TOTAL
INCLUINDO A INDUÇÃO
FULL COMPATIBILITY
INCLUDING INDUCTION
COMPATIBILIDAD TOTAL
INCLUIDO LA INDUCCIÓN
COMPATIBILITÉ TOTALE,
Y COMPRIS L'INDUCTION
وافق مع جميع مصادر
الحرارة ومن ضمنها
إندوة القوت الحثري



Caçarola
Casserole • Cacerola • Faitout • طنجرة



COMFORT
Ø16cm-1,5Lts
Aço Inoxidável
Stainless Steel
Acero Inoxidable
Acier Inoxydable
صلب مقاوم للصدأ



TECNOLOGIA
MULTIDISC
3 PLY
FABRICADO EM
MADE IN
PORTUGAL
eco COOK
10
Anos Garantia
Years Warranty
Años Garantie

RÓTULO AUTOCOLANTE DE CAIXA
BOX STICKER LABEL

DÍSTICOS MULTIDISC
MULTIDISC SLEEVES



DÍSTICOS IMPACTDISC
IMPACTDISC SLEEVES

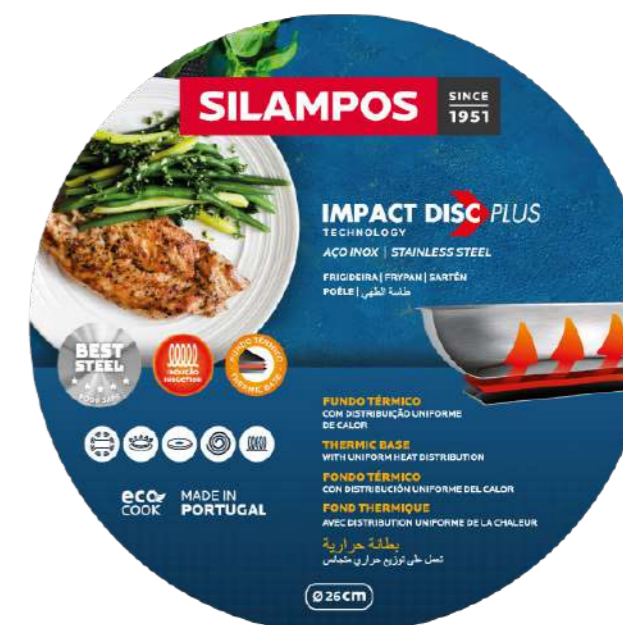

COZINHA NO MUNDO

WORLD CUISINE

COZINHADOS DIVERTIDOS

FUN COOKING



FRIGIDEIRAS

FRYPANS

DAILY

Compatível com os seguintes modelos:

Suitable for the following cookware models:

EUROPA
LOW COST ESSENTIAL
LOW COST CLASSIC
LOW COST ESSENTIAL GLASS
LOW COST CLASSIC GLASS

FRIGIDEIRA CÓNICA ANTIADERENTE NON-STICK CONICAL FRYING PAN

Diam.(cm)	Alt.(cm)	Capac.(L)	Artigo
Diam.(cm)	Hgh(cm)	Capac.(L)	Article
Ø20	4.4	1	63C12AGK5620V
Ø24	4.9	1.7	63C12AGK5624V
Ø26	5	2	63C12AGK5626V
Ø28	5	2.3	63C12AGK5628V



FOOD SAFE
PFOA/NMP
FREE

FRIGIDEIRA CÓNICA CONICAL FRYING PAN

Diam.(cm)	Alt.(cm)	Capac.(L)	Artigo
Diam.(cm)	Hgh(cm)	Capac.(L)	Article
Ø20	4.4	1	63C122GK5620V
Ø24	4.9	1.7	63C122GK5624V
Ø26	5	2	63C122GK5626V
Ø28	5	2.3	63C122GK5628V



CATAPLANAS

SABORES PORTUGUESES PORTUGUESE FLAVOURS

Tipicamente algarvio, este utensílio de cozinha segue um processo de cozedura a vapor realçando, desta forma, todo o aroma e sabor dos alimentos. A sua beleza e facilidade de manuseamento torna-a numa peça prática e decorativa em qualquer cozinha ou mesa.

A cataplana Silampos está disponível em dois modelos: **Cataplana Algarve**

É o modelo típico da cataplana. A tampa está fixa ao corpo através de uma mola.

Cataplana Aroma

Não possui mola de fixação, a tampa pode ser removida imediatamente.

This is a typical utensil of the Algarve region. It follows a steaming process which highlights, in this way, all the aroma and taste of food. Its attractive design and easy handling make it a practical and decorative piece in any kitchen or table.

SILAMPOS cataplanas are available in two models:

Cataplana Algarve

It is the typical cataplana model. The lid is fixed to the body with a hinge.

Cataplana Aroma

As there is no hinge, the lid can be removed immediately, after taking off the lateral closing Springs.

- 1 A tampa faz parte integrante da cataplana**
Sendo de grande importância desde a cozedura até à mesa, podendo ser utilizada como apoio.
The lid is totally part of the cataplana
Being of major importance from the hob to the table.
- 2 Geometria da beira**
Permite que os sucos e vapores condensados da cozedura não escorram da cataplana.
Geometry of the border
Avoid juices and condensed vapours to drain off the cataplana.
- 3 Fundo térmico Impact Disc Plus**
+ Rapidez + Poupança de energia
Impact Disc Plus thermic bottom
+ Quickness + Energy saving
- 4 Geometria semiesférica do corpo e da tampa**
Gera um fluxo de vapor que conduz à cozedura dos alimentos, preservando a água e nutrientes.
Semi-spherical geometry of the body and lid
It generates a flow of steam to cook the food, preserving water and nutrients.



CATAPLANA ALGARVE CATAPLANA ALGARVE

Diam.(cm)	Alt.(cm)	Capac.(L)	Artigo
Diam.(cm)	Hgh(cm)	Capac.(L)	Article
Ø24	7.5	2.5	632122322524
Ø28	8.5	3.4	632122322528
Ø32	9.1	4.5	632122322532
Ø36	9.1	7.6	632222322536

Mola Fixa
Fixing Spring



SUPORTE CATAPLANA CATAPLANA SUPPORT

Alt.(cm)	Artigo
Hgh(cm)	Article
19	631000009900



CATAPLANA AROMA CATAPLANA AROMA

Diam.(cm)	Alt.(cm)	Capac.(L)	Artigo
Diam.(cm)	Hgh(cm)	Capac.(L)	Article
Ø24	7.5	2.5	632122322524A
Ø28	8.5	3.4	632122322528A
Ø32	9.1	4.5	632122322532A
Ø36	9.1	7.6	632222322536A



WOKS

SALTEIE OS ALIMENTOS SAUTÉ YOUR FOOD

Desfrute os sabores do oriente no seu wok Silampos. Esta peça é indispensável na alimentação saudável, na medida em que preserva os elementos vitais e valiosos dos alimentos. Os alimentos são salteados sob um agitar permanente, o que proporciona uma preparação uniforme dos vegetais, carne ou peixe. A sua grelha permite o aquecimento prolongado e o gotejamento da carne ou do peixe.

Enjoy the flavours of the orient with your wok Silampos. This piece is essential for an healthy diet, as it preserves the vital and valuable elements of food. Food is sautéed under a continuous stirring, which provides a uniform preparation of the vegetables, meat or fish. The grid allows its prolonged heating and drip of the meat or fish.



Atlântico Glass



FOOD SAFE
PFOA/NMP
FREE

WOK C/ CABO ANTIADERENTE E TAMPA DE VIDRO
NON-STICK WOK W/ LONG HANDLE + GLASS LID

Diam.(cm)	Alt.(cm)	Capac.(L)	Artigo
Ø28	10.6	4.6	63212AV59328



Yumi Glass



FOOD SAFE
PFOA/NMP
FREE

WOK C/ASAS + GRELHA ANTIADERENTE
NON-STICK WOK W/HANDLES + GRID

Diam.(cm)	Alt.(cm)	Capac.(L)	Artigo
Ø28	10.6	4.6	63212AV18428



WOKS

Nautilus

Europa



WOK C/ASAS + GRELHA ANTIADERENTE
NON-STICK WOK W/HANDLES + GRID

Diam.(cm)	Alt.(cm)	Capac.(L)	Artigo
Diam.(cm)	Hgh(cm)	Capac.(L)	Article
Ø28	10.6	4.6	63212AVE8428



WOK C/ASAS + GRELHA
WOK W/HANDLES + GRID

Diam.(cm)	Alt.(cm)	Capac.(L)	Artigo
Diam.(cm)	Hgh(cm)	Capac.(L)	Article
Ø36	10.2	7.6	63222328405



GRELHA P/ WOK
WOK GRIDDLE

Diam.(cm)	Artigo
Diam.(cm)	Article
Ø28	412418171728



WOK C/CABO SEM GRELHA ANTIADERENTE
NON STICK WOK

Diam.(cm)	Alt.(cm)	Capac.(L)	Artigo
Diam.(cm)	Hgh(cm)	Capac.(L)	Article
Ø28	10.6	4.6	63212A599328A



WOK C/CABO SEM GRELHA ANTIADERENTE
NON-STICK WOK

Diam.(cm)	Alt.(cm)	Capac.(L)	Artigo
Diam.(cm)	Hgh(cm)	Capac.(L)	Article
Ø28	10.6	4.6	63212A329328A

FRIGIDEIRAS / FRITADEIRAS

FRYPANS / CHIP PANS

É HORA DE FRITAR
FRYING TIME



Europa



FRIG/FRIT + CESTO + PROTETOR DE SALPICOS
FRYPAN/CHIP PAN+BASKET+GUARD

Diam.(cm)	Alt.(cm)	Capac.(L)	Artigo
Ø24	6.5	2.6	632122329624A

Nautilus



CESTO FRIGIDEIRA/FRITADEIRA
FRYPAN BASKET

Diam.(cm)	Alt.(cm)	Artigo
Ø21.5	8.5	411317897016



FRIG/FRIT + CESTO + PROTETOR DE SALPICOS
FRYPAN/CHIP PAN+BASKET+GUARD

Diam.(cm)	Alt.(cm)	Capac.(L)	Artigo
Ø24	6.5	2.6	632125599624A



Europa



CAÇAROLA/FRIT. C/ASAS C/CESTO
CHIP PAN + BASKET

Diam.(cm)	Alt.(cm)	Capac.(L)	Artigo
Diam.(cm)	Hgh(cm)	Capac.(L)	Article
Ø24	10	4.2	632122VM9724

Nautilus



CAÇAROLA/FRIT. C/ASAS C/CESTO
CHIP PAN + BASKET

Diam.(cm)	Alt.(cm)	Capac.(L)	Artigo
Diam.(cm)	Hgh(cm)	Capac.(L)	Article
Ø24	10	4.2	632125VE9724

Yumi Glass



FRITAD. C/ASAS 24 C/CESTO
CHIP PAN + BASKET

Diam.(cm)	Alt.(cm)	Capac.(L)	Artigo
Diam.(cm)	Hgh(cm)	Capac.(L)	Article
Ø24	10	4.2	632122VJ9724

Silampos

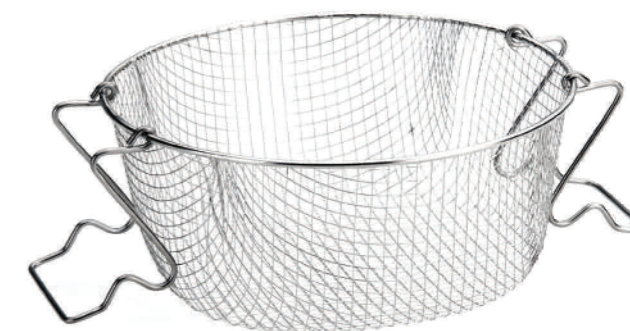

CESTO FRITADEIRA AÇO INOX
STAINLESS STEEL CHIP PAN BASKET

Diam.(cm)	Alt.(cm)	Artigo
Diam.(cm)	Hgh(cm)	Article
Ø21.5	8.5	411317897010

GRELHADORES QUADRADOS

SQUARE GRILLS

GRELHADOS PERFEITOS

PERFECT GRILLINGS

Os grelhados são indispensáveis para uma dieta saudável, uma vez que os alimentos são cozinhados sem adição de gorduras (a seco) através dos seus próprios sucos.

The grills are essential to a healthy diet, since the food is cooked without added fat (dry) through its own juices.

Europa



GRELHADOR QUADRADO ANTIADERENTE

NON-STICK SQUARE GRILL

Diam.(cm)	Alt.(cm)	Artigo
Ø27	3.9	63222A326127



GRELHADORES CIRCULARES

ROUND GRILLS

Yumi



GRELHADOR CIRCULAR ANTIADERENTE

NON-STICK ROUND GRILL

Diam.(cm)	Alt.(cm)	Artigo
Ø28	2	63222AAC6128
Ø34	2	63222AAC6105



Nautilus

Europa



GRELHADOR QUADRADO ANTIADERENTE

NON-STICK SQUARE GRILL

Diam.(cm)	Alt.(cm)	Artigo
Ø27	3.9	63222A596127



GRELHADOR CIRCULAR ANTIADERENTE

NON-STICK ROUND GRILL

Diam.(cm)	Alt.(cm)	Artigo
Ø28	2	63222A326128
Ø34	3.2	63222A326105



PAELLERA PAELLA PAN

TIPICAMENTE IBÉRICO
VERY IBERIC

Nautilus

A paella é um prato tipicamente ibérico mas tem vindo a adquirir cada vez mais importância na gastronomia internacional. A paellera apresenta um formato cónico de 30cm, com asas e tampa para poder responder às exigências da confeção e também servir à mesa.

The paella is a typically iberic dish but has been increasingly gain importance in the international cuisine. The paella pan has a conical shape (30cm), handles and lid to meet the demands of the cooking process and also to serve at the table.



FOOD
SAFE
PFOA/NMP
FREE

PAELLERA ANTIADERENTE
NON-STICK PAELLERA W/LID

Diam.(cm)	Alt.(cm)	Capac.(L)	Artigo
Diam.(cm)	Hgh(cm)	Capac.(L)	Article
Ø30	3.2	3.5	63222A595330A

COZER A VAPOR STEAMERS

DEIXE O VAPOR COZINHAR LET STEAM COOK

No processo de cozedura a vapor os alimentos cozem dentro de um recipiente (caçarola de cozer a vapor) que é sobreposta numa panela com água a ferver (mas sem contacto direto com o líquido). A cozinha a vapor preserva o sabor, a cor, a textura assim como os nutrientes e as vitaminas dos alimentos.

In the process of steam cooking baking food in a container (casserole steaming) which is superimposed on a pan of boiling water (but without direct contact with the liquid). The steam cooking preserves the flavour, colour, texture, as well as vitamins and nutrients of the food.



Adaptável a 3 diâmetros
Adaptable to 3 diameters

Nautilus



CAÇAROLA TRIPLA COZER VAPOR C/ ASAS
MULTISTEAMER W/HANDLES

Diam.(cm)	Alt.(cm)	Adapta-se a 3 diam.	Artigo
Diam.(cm)	Hgh(cm)	Suitable for 3 diam.	Article
Ø20	9.2	16/18/20 cm	631002591820
Ø26	11.2	22/24/26 cm	631002591826

Profissional Tejo



CAÇAROLA TRIPLA COZER VAPOR C/ ASAS
MULTISTEAMER W/HANDLES

Diam.(cm)	Alt.(cm)	Adapta-se a 3 diam.	Artigo
Diam.(cm)	Hgh(cm)	Suitable for 3 diam.	Article
Ø20	9.2	16/18/20 cm	631002631820
Ø26	11.2	22/24/26 cm	631002631826

Europa



CAÇAROLA TRIPLA COZER VAPOR C/ ASAS
MULTISTEAMER W/HANDLES

Diam.(cm)	Alt.(cm)	Adapta-se a 3 diam.	Artigo
Diam.(cm)	Hgh(cm)	Suitable for 3 diam.	Article
Ø20	9.2	16/18/20 cm	631002321820
Ø26	11.2	22/24/26 cm	631002321826



CAÇAROLA TRIPLA COZER VAPOR C/CABO
MULTISTEAMER W/LONG HANDLE

Diam.(cm)	Alt.(cm)	Adapta-se a 3 diam.	Artigo
Diam.(cm)	Hgh(cm)	Suitable for 3 diam.	Article
Ø20	9.2	16/18/20 cm	631002321920
Ø26	11.2	22/24/26 cm	631002321926

COUSCOUSSIERS

SABOR MÁGICO
MAGIC TASTE

O couscoussier é usado para cozer a vapor o cuscus (ingrediente tipicamente usado na cozinha árabe, especialmente na Argélia, Líbia, Marrocos e Tunísia). É composto por uma panela base que contém água para gerar o vapor e por um recipiente perfurado (por cima da panela) onde é colocado o cuscus. Quando o cuscus estiver cozido, pode utilizar o recipiente perfurado para servir.

The Couscoussier is a traditional double-chambered food steamer used in Berber and Arabic cuisines (particularly Algerian, Libyan, Moroccan and Tunisian) to cook Couscous. The stockpot holds water used to make steam. The smaller pot, which is placed on top and has a lid, is perforated on the bottom so that it holds the couscous in place while allowing steam to enter. Once the couscous is steam-cooked the lower pot may be used to simmer and serve the prepared dish.

Europa



COUSCOUSSIERS

Diam.(cm)	Alt.(cm)	
Diam.(cm)	Hgh(cm)	
Ø20	8,4	Couscoussier
	11	Panela base Stockpot
Ø24	10,5	Couscoussier
	16	Panela base Stockpot
Ø26	8,9	Couscoussier
	16	Panela base Stockpot
Capac.(L)	Artigo	
Capac.(L)	Article	
4	632122320102100	
6,7	632122320010100	
8,3	632122320008100	

Europa Glass



COUSCOUSSIERS

Diam.(cm)	Alt.(cm)	
Diam.(cm)	Hgh(cm)	
Ø20	8,4	Couscoussier
	11	Panela base Stockpot
Ø24	10,5	Couscoussier
	16	Panela base Stockpot
Ø26	8,9	Couscoussier
	16	Panela base Stockpot
Capac.(L)	Artigo	
Capac.(L)	Article	
4	632122VM0102100	
6,7	632122VM0010100	
8,3	632122VM0008100	

Low Cost Essential



COUSCOUSSIERS

Diam.(cm)	Alt.(cm)	
Diam.(cm)	Hgh(cm)	
Ø20	8,4	Couscoussier
	11	Panela base Stockpot
Ø24	10,5	Couscoussier
	16	Panela base Stockpot
Ø26	8,9	Couscoussier
	16	Panela base Stockpot
Capac.(L)	Artigo	
Capac.(L)	Article	
4	63C122E00102100	
6,7	63C122E00010100	
8,3	63C122E00008100	

Low Cost Essential Glass



COUSCOUSSIERS

Diam.(cm)	Alt.(cm)	
Diam.(cm)	Hgh(cm)	
Ø20	8,4	Couscoussier
	11	Panela base Stockpot
Ø24	10,5	Couscoussier
	16	Panela base Stockpot
Ø26	8,9	Couscoussier
	16	Panela base Stockpot
Capac.(L)	Artigo	
Capac.(L)	Article	
4	63C122WG0102100	
6,7	63C122WG0010100	
8,3	63C122WG0008100	

TUTTI-PASTA

PARA MASSA, MARISCO E MUITO MAIS...
FOR PASTA, SEAFOOD AND SO ON...

Europa



CONJUNTO TUTTI-PASTA TUTTI-PASTA SET

Diam.(cm)	Alt.(cm)	Capac.(L)	Artigo
Diam.(cm)	Hgh(cm)	Capac.(L)	Article
Ø20	22 Esp. Pasta Pot	6.3	632122320001
	20.5 Panela Stockpot		



CONJUNTO TUTTI-PASTA BAIXO LOW TUTTI-PASTA SET

Diam.(cm)	Alt.(cm)	Capac.(L)	Artigo
Diam.(cm)	Hgh(cm)	Capac.(L)	Article
Ø20	14.5 Esp. Pasta Pot	4	632122320201
	13 Panela Stockpot		



TUTTI-PASTA

Nautilus



CONJUNTO TUTTI-PASTA
TUTTI-PASTA SET

Diam.(cm)	Alt.(cm)	Capac.(L)	Artigo
Diam.(cm)	Hgh(cm)	Capac.(L)	Article
Ø20	22 Esp. Pasta Pot	6.3	632125590001
	20.5 Panela Stockpot		



CONJUNTO TUTTI-PASTA BAIXO
LOW TUTTI-PASTA SET

Diam.(cm)	Alt.(cm)	Capac.(L)	Artigo
Diam.(cm)	Hgh(cm)	Capac.(L)	Article
Ø20	14.5 Esp. Pasta Pot	4	632125590201
	13 Panela Stockpot		

Profissional Tejo



CONJUNTO TUTTI-PASTA
TUTTI-PASTA SET

Diam.(cm)	Alt.(cm)	Capac.(L)	Artigo
Diam.(cm)	Hgh(cm)	Capac.(L)	Article
Ø20	22 Esp. Pasta Pot	6.3	632123630001
	20.5 Panela Stockpot		

Profissional Tejo 2000



CONJUNTO TUTTI-PASTA
TUTTI-PASTA SET

Diam.(cm)	Alt.(cm)	Capac.(L)	Artigo
Diam.(cm)	Hgh(cm)	Capac.(L)	Article
Ø20	22 Esp. Pasta Pot	6.3	632125640001100
	20.5 Panela Stockpot		



PANELA ESCORREDORA

STRAINING POT

NOVO
NEW

Charme

Panela em aço inoxidável com tampa escorredora.
2 em 1 : permite cozer e escorrer.

Stainless steel pot with straining lid.
2 in 1: allows you to boil and drain.



Pegas ergonómicas em silicone
Ergonomical Silicone Handles

Tampa perfurada
Straining lid

Aço inoxidável
Stainless Steel

Fundo Térmico
Stainless Steel

PANELA ESCORREDORA
STRAINING POT

Diam.(cm)	Alt.(cm)	Capac.(L)	Artigo
Diam.(cm)	Hgh(cm)	Capac.(L)	Article
Ø20	13.6	4	63C122FH6920

IMPACT DISC PLUS
TECHNOLOGY



FONDUES

UM PARA TODOS
ONE FOR ALL

O utensílio imprescindível para criar um ambiente caloroso à mesa, no qual poderá confeccionar todo o tipo de fondues: queijo, chocolate, carne ou peixe. Uma explosão de sabores e aromas.

The essential utensil to create a warm environment at your table, in which you'll be able to cook all kinds of fondues: cheese, chocolate, meat or fish. An explosion of flavours and aromas.



IMPACT DISC PLUS



FONDUE RECTANGULAR
RECTANGULAR FONDUE

Diam.(cm) Artigo
Diam.(cm) Article
Ø16 632125595916

Nautilus



FONDUE/ GRELHADOR DE PEDRA
FONDUE/ STONE GRILL

Diam.(cm) Artigo
Diam.(cm) Article
Ø16 632125596016

IMPACT DISC PLUS



FONDUE 18 COMPLETO 6 TAÇAS
COMPLETE FONDUE 18 W/ 6 CUPS

Diam.(cm) Artigo
Diam.(cm) Article
Ø18 636122AC5918D

Yumi



FONDUE 18 SIMPLES
SIMPLE FONDUE 18

Diam.(cm) Artigo
Diam.(cm) Article
Ø18 636122AC5918

FONDUES

Silamos

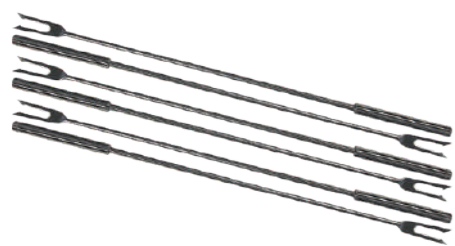

CONJUNTO 6 GARFOS P/ FONDUE
6 FONDUE FORKS SET

Alt.(cm)	Artigo
Hgh(cm)	Article
2	412481860010



CAIXA C/ 3 RECARGAS DE GEL
3 REFILLS OF COMBUSTIBLE BOX

Alt.(cm)	Artigo
Hgh(cm)	Article
2.5	415916010600



TAÇA MOLHOS SATINADO
SATIN SAUCE CUP

Alt.(cm)	Artigo
Hgh(cm)	Article
4.5	631001002808



LAMPARINA C/ RECARGA
LAMP WITH REFILL

Alt.(cm)	Artigo
Hgh(cm)	Article
3	415916010610

Yumi



TAÇA MOLHOS POLIDA YUMI
POLISHED SAUCE CUP YUMI

Alt.(cm)	Artigo
Hgh(cm)	Article
4.5	631002002808E

GRELHADOR DE PEDRA STONE GRILL

COOKING LIKE THAT IS FUN COZINHAR ASSIM É DIVERTIDO

Os grelhados são indispensáveis para uma dieta saudável, uma vez que os alimentos são cozinhados sem adição de gorduras (a seco) através dos seus próprios sucos.

The grills are essential to a healthy diet, since the food is cooked without added fat (dry) through its own juices.



GRELHADOR DE PEDRA
STONE GRILL

Comp.(cm)	Larg.(cm)	Alt.(cm)	Artigo
Len.(cm)	Wid(cm)	Hgh(cm)	Article
41	27	10.5	631002006300



PEDRA 285*215*15 C/RASGO
STONE W/ SLIT 285*215*15

Alt.(cm)	Artigo
Hgh(cm)	Article
1.5	419182006400

TABULEIROS

OVEN TRAY

RECEITAS DE FORNO

OVEN RECIPES

Prepare as melhores receitas de forno com o tabuleiro. Poderá assar e gratinar todo o tipo de alimentos (carnes, peixes, legumes e massas), controlando a temperatura de forma a manter o interior dos alimentos mais macio, suculento e o exterior crocante.

Prepare the best oven recipes with the baking dishes. You will be able to bake and brown all kinds of foods (meat, fish, vegetables and pasta), through temperature control, keeping the food inside soft, juicy and the outside crispy.



Europa



TABULEIRO C/ASAS C/GRELHA
BAKING DISH W/ HANDLES + GRID

Comp.(cm)	Larg.(cm)	Alt.(cm)	Artigo
Len.(cm)	Wid(cm)	Hgh(cm)	Article
27	27	5.4	631002327827



TABULEIRO S/ASAS C/GRELHA
BAKING DISH NO HANDLES W/GRID

Comp.(cm)	Larg.(cm)	Alt.(cm)	Artigo
Len.(cm)	Wid(cm)	Hgh(cm)	Article
27	27	5.4	631002327827B



TABULEIRO C/ASAS C/GRELHA
BAKING DISH W/ HANDLES + GRID

Comp.(cm)	Larg.(cm)	Alt.(cm)	Artigo
Len.(cm)	Wid(cm)	Hgh(cm)	Article
36	27	5.5	631002327836



TABULEIRO S/ASAS C/GRELHA
BAKING DISH NO HANDLES W/GRID

Comp.(cm)	Larg.(cm)	Alt.(cm)	Artigo
Len.(cm)	Wid(cm)	Hgh(cm)	Article
36	27	5.5	631002327836B



TABULEIRO C/ ASAS
BAKING DISH W/ HANDLES

Comp.(cm)	Larg.(cm)	Alt.(cm)	Artigo
Len.(cm)	Wid(cm)	Hgh(cm)	Article
27	27	5.4	631002327827A



TABULEIRO C/ASAS
BAKING DISH W/ HANDLES

Comp.(cm)	Larg.(cm)	Alt.(cm)	Artigo
Len.(cm)	Wid(cm)	Hgh(cm)	Article
36	27	5.5	631002327836A

Disponíveis com revestimento antiaderente Available with non-stick coating

TABULEIROS

OVEN TRAY

Sado

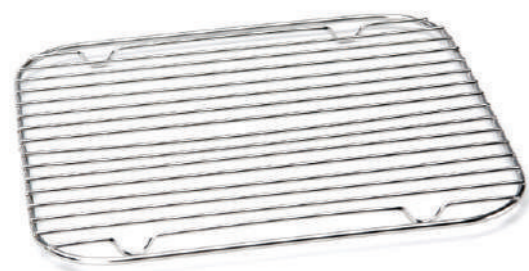

GRELHA TABULEIRO
BAKING DISH GRID

Comp.(cm)	Larg.(cm)	Artigo
Len.(cm)	Wid(cm)	Article
27	27	632000329901

TABULEIRO C/ASAS C/GRELHA SADO
BAKING DISH W/ HANDLES + GRID SADO

Comp.(cm)	Larg.(cm)	Alt.(cm)	Artigo
Len.(cm)	Wid(cm)	Hgh(cm)	Article
27	27	5.4	631002667827

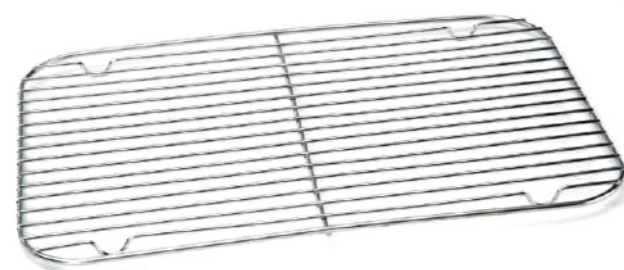

GRELHA TABULEIRO
BAKING DISH GRID

Comp.(cm)	Larg.(cm)	Artigo
Len.(cm)	Wid(cm)	Article
36	27	632000329902

TABULEIRO C/ASAS C/GRELHA SADO
BAKING DISH W/ HANDLES + GRID SADO

Comp.(cm)	Larg.(cm)	Alt.(cm)	Artigo
Len.(cm)	Wid(cm)	Hgh(cm)	Article
36	27	5.5	631002667836



ESCOADORES COLANDERS

LAVAR E ESCORRER
WASH AND DRAIN



Europa



ESCOADOR C/ASAS
COLANDER W/HANDLES

Diam.(cm)	Alt.(cm)	Artigo
Diam.(cm)	Hgh(cm)	Article
Ø26	14	631002323226



ESCOADOR C/CABO E ASA
COLANDER W/HELPER HANDLE

Diam.(cm)	Alt.(cm)	Artigo
Diam.(cm)	Hgh(cm)	Article
Ø26	14	631002323326

Nautilus



ESCOADOR C/ASAS
COLANDER W/HANDLES

Diam.(cm)	Alt.(cm)	Artigo
Diam.(cm)	Hgh(cm)	Article
Ø26	14	631002593226

CAFETEIRA SIENA

SIENA TEAPOT

MOMENTOS RELAXANTES
RELAXING MOMENTS



CAFETEIRA C/ ASA SIENA
SIENA TEAPOT

Diam.(cm)	Alt.(cm)	Capac.(L)	Artigo
Diam.(cm)	Hgh(cm)	Capac.(L)	Article
Ø14	14	2	63F122DG2220
Ø14	17.3	2.5	63F122DG2225



ANTIADERENTES NON STICK COOKWARE



ALUMINIUM THERMORRESIST
TECHNOLOGY



NON-STICK COATING
**FORCE
FLON
2+**
TITANIUM + CERAMIC REINFORCED

**FOOD
SAFE**
PFOA/NMP
FREE

LOUÇA PARA COZINHAR EM ALUMÍNIO
ALUMINIUM COOKWARE

ANTIADERENTES NON STICK COOKWARE

Vénus

ALUMINIUM THERMO RESIST
TECHNOLOGY

FRIGIDEIRA C/ CABO FRYPAN

Diam.(cm)	Alt.(cm)	Artigo
Diam.(cm)	Hgh(cm)	Article
Ø18	5	440000025618
Ø20	6	440000025620
Ø22	6	440000025622
Ø24	6	440000025624
Ø26	6	440000025626
Ø28	6	440000025628



FOOD
SAFE
PFOA/NMP
FREE

CAÇAROLA C/ CABO SAUCEPAN

Diam.(cm)	Alt.(cm)	Capac.(L)	Artigo
Diam.(cm)	Hgh(cm)	Capac.(L)	Article
Ø16	8.5	0.5	440000025116
Ø18	8.5	0.6	440000025118
Ø20	10	0.7	440000025120



GRELHADOR RELEVO C/ 2 BICOS SQUARE GRILL WITH 2 POURING LIPS

Dim.(cm)	Alt.(cm)	Artigo
Dim.(cm)	Hgh(cm)	Article
26x26	4.5	440000025126

CREPEIRA CREPE PAN

Diam.(cm)	Alt.(cm)	Artigo
Diam.(cm)	Hgh(cm)	Article
Ø24	6	440000025824



GRELHADOR C/RELEVO SQUARE GRILL

Dim.(cm)	Alt.(cm)	Artigo
Dim.(cm)	Hgh(cm)	Article
26x26	4.5	440000025126B



GRELHADOR PLANO FLAT SQUARE GRILL

Dim.(cm)	Alt.(cm)	Artigo
Dim.(cm)	Hgh(cm)	Article
26x26	2	440000025126A



WOK C/ CABO WOK

Diam.(cm)	Alt.(cm)	Capac.(L)	Artigo
Diam.(cm)	Hgh(cm)	Capac.(L)	Article
Ø28	8	1	440000025328

Compatibilidade com todas as fontes de calor, incluindo indução
Compatibilidade com todas as fontes de calor, incluindo indução

PANELAS DE PRESSÃO

PRESSURE COOKERS

SOB PRESSÃO

UNDER PRESSURE





Chef
Lígia Santos
1ª Masterchef Portugal

STARTWIST

Twist and start cooking

STARTWIST

TWIST AND START COOKING



Aço inoxidável 18/10.
 Garantia 10 anos.
 Pode colocar a tampa em qualquer posição.
 2 níveis de pressão.
 Sistema fácil de abertura e fecho por garras.
 Compatível com todas as fontes de calor, incluindo a indução.

Stainless Steel 18/10.
 Warranty 10 years.
 Place the lid in any position.
 2 levels of pressure.
 Clamp system for easy opening/closing.
 Suitable for all heat sources, including induction.

P.PRESSÃO S/CESTO PRESS.COOKER NO BASKET

Diam.(cm)	Alt.(cm)	Capac.(L)	Artigo
Diam.(cm)	Hgh(cm)	Capac.(L)	Article
24	14.5	6	64A122018706
24	18.9	8	64A122018708
24	23.4	10	64A122018710





VÁLVULA REGULAÇÃO
CONTROL VALVE

Artigo
Article
64A000019901 Individual



JUNTA VEDAÇÃO EM SILICONE
SILICONE SEALING RING

Artigo
Article
64A000019903 Individual



ASA LATERAL BAQUELITE
BAKELITE SIDE HANDLE

Artigo
Article
64A000019902 Individual



O-RING VÁLVULA SEGURANÇA
SAFETY O-RING VALVE

Artigo
Article
64A000019904 Individual

OPEN CONTROL

A SEGURANÇA REFORÇADA SOBRE A QUAL PODE CONTAR
THE IMPROVED SAFETY YOU CAN RELY ON

Sistema de segurança suplementar que garante a impossibilidade de abertura da panela no caso de haver pressão no seu interior. A combinação funcional da roda de encaixe com o pino colorido não permite a sua abertura.

Additional safety system which ensures complete locking when the cooker is still under pressure. The combination of the locking disc with the coloured indicator does not allow the lid opening.

Mais segurança na abertura / Funcionamento mais intuitivo / Maior fiabilidade

Safer opening / intuitive working / More reliability



SACO SILAMPOS
SILAMPOS BAG



P.PRESSÃO S/CESTO INOX220
PRESS.COOKER NO BASKET INOX220

Diam.(cm)	Alt.(cm)	Capac.(L)	Artigo
Diam.(cm)	High(cm)	Capac.(L)	Article
22	12.9	4.5	641122078745
22	16.9	6	641122078760

P.PRESSÃO S/CESTO INOX245
PRESS.COOKER NO BASKET INOX245

Diam.(cm)	Alt.(cm)	Capac.(L)	Artigo
Diam.(cm)	High(cm)	Capac.(L)	Article
24.5	17.7	8	643122078708
24.5	21.9	10	643122078710
24.5	26.2	12	643122078712



JUNTA VEDAÇÃO BORRACHA 220
RUBBER SEALING RING 220

Artigo
Article
621000019947 Pack
621000019966 Individual
Legenda 18
Subtitle



CONJ. ASA + PARAFUSO
SIDE HANDLE + SCREW SET

Artigo
Article
621000019950 Pack
621000019969 Individual
Legenda 17 20
Subtitle



BOTÃO APERTO
EM BAQUELITE
BAKELITE LOCKING LEVER

Artigo
Article
621000019940A Pack
621000019960 Individual
Legenda 6
Subtitle



JUNTA VEDAÇÃO BORRACHA 245
RUBBER SEALING RING 245

Artigo
Article
621000019945 Pack
621000019964 Individual
Legenda 18
Subtitle



CONJ. PINO
COLORIDO CONTROL
RED CONTROL
INDICATOR SET

Artigo
Article
641000079902 Individual
Legenda 9 10
Subtitle



CESTO INTERIOR EM
ALUMÍNIO 220/245
ALUMINIUM INNER BASKET

Diam.(cm) Artigo
Diam.(cm) Article
22 621000019913
24.5 622000019913
Legenda 19
Subtitle



CONJ. RODA PERFORADA CONTROL
PERFORATED CONTROL WHEEL SET

Artigo
Article
641000079901 Individual
Legenda 2 5 8 12
Subtitle



CONJ. VÁL. REGULAÇÃO + SUPORTE
CONTROL VALVE +SUPPORT SET

Artigo
Article
621000019941 Pack
621000019961 Individual
Legenda 1 13 15
Subtitle



VÁLVULA SEGURANÇA
SAFETY VALVE

Artigo
Article
621000019944 Pack
621000019963 Individual
Legenda 4 14
Subtitle

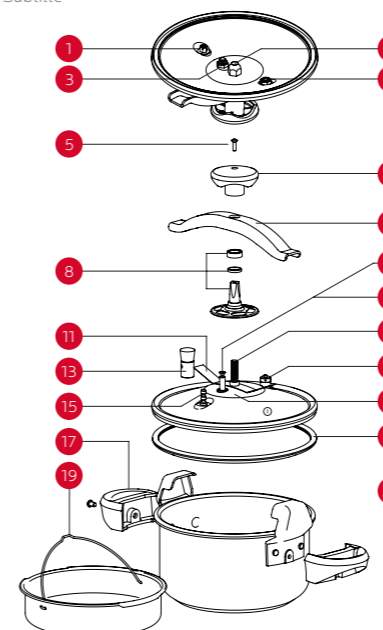

ESQUEMA | SCHEME

1. PORCA DA VÁLVULA DE REGULAÇÃO
SAFETY VALVE NUT
2. PORCA DO PARAFUSO CENTRAL
CENTRE AXIS NUT
3. PORCA DO INDICADOR DE PRESSÃO
CONTROL INDICATOR NUT
4. PORCA DA VÁLVULA DE SEGURANÇA
CONTROL VALVE NUT
5. PARAFUSO DO BOTÃO DE APERTO M5X13
LOCKING LEVER SCREW M5X13
6. BOTÃO DE APERTO EM BAQUELITE
BAKELITE LOCKING LEVER
7. TRAVESSÃO EM AÇO INOXIDÁVEL
STAINLESS STEEL YOKE
8. RODA PERFORADA + ROSCA DE FIXAÇÃO + ANILHAS
PERFORATED WHEEL+ FIXING NUT + RINGS
9. TAMPA DO INDICADOR DE PRESSÃO
CONTROL INDICATOR LID
10. INDICADOR DE PRESSÃO
CONTROL INDICATOR

11. LIMITADOR DO TRAVESSÃO
LIMITER YOKE
12. PARAFUSO CENTRAL
CENTRE AXIS
13. VÁLVULA DE REGULAÇÃO
CONTROL VALVE
14. VÁLVULA DE SEGURANÇA
SAFETY VALVE
15. SUPORTE DA VÁLVULA DE REGULAÇÃO
CONTROL VALVE SUPPORT
16. RODELA
RING
17. ASA LATERAL EM BAQUELITE
BAKELITE SIDE HANDLE
18. JUNTA DE VEDAÇÃO LABIAL EM BORRACHA
RUBBER SEALING RING
19. CESTO INTERIOR EM ALUMÍNIO (OPCIONAL)
ALUMINIUM INNER BASKET (OPTIONAL)
20. PARAFUSO DE FIXAÇÃO DA ASA
HANDLE FIXING SCREW

TRADICIONAL

A TRADIÇÃO É INTEMPORAL
TRADITION IS TIMELESS

AÇO INOX
STAINLESS STEEL



P.PRESSÃO S/CESTO INOX 220
PRESS.COOKER NO BASKET INOX 220

Diam.(cm)	Alt.(cm)	Capac.(L)	Artigo
22	12.9	4.5	641122018745
22	16.9	6	641122018760

P.PRESSÃO S/CESTO INOX 245
PRESS.COOKER NO BASKET INOX 245

Diam.(cm)	Alt.(cm)	Capac.(L)	Artigo
24.5	17.7	8	643122018708
24.5	21.9	10	643122018710
24.5	26.2	12	643122018712

P.PRESSÃO S/CESTO INOX 280
PRESS.COOKER NO BASKET INOX 280

Diam.(cm)	Alt.(cm)	Capac.(L)	Artigo
28	17.2	10	64D122018710
28	20.3	12	64D122018712
28	26.8	16	64D122018716

SACO SILAMPOS
SILAMPOS BAG



Válido apenas em tamanhos específicos
Available only for specific sizes

ESQUEMA | SCHEME

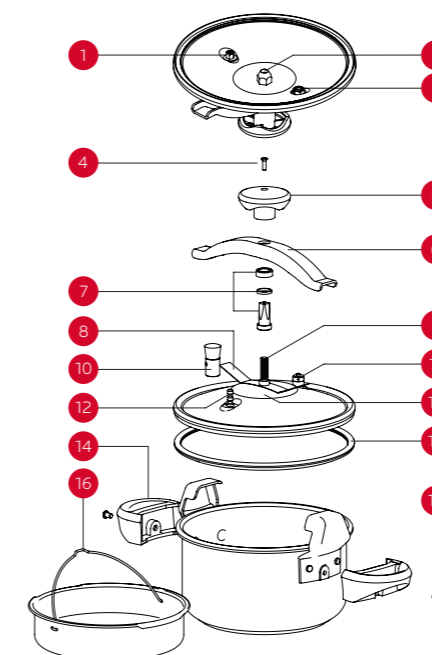

- 1. PORCA DA VÁLVULA DE REGULAÇÃO
SAFETY VALVE NUT
- 2. PORCA DO PARAFUSO CENTRAL
CENTRE AXIS NUT
- 3. PORCA DA VÁLVULA DE SEGURANÇA
CONTROL VALVE NUT
- 4. PARAFUSO DO BOTÃO DE APERTO M5X13
LOCKING LEVER SCREW M5X13
- 5. BOTÃO DE APERTO EM BAQUELITE
LOCKING LEVER
- 6. TRAVESSÃO EM AÇO INOXIDÁVEL
STAINLESS STEEL YOKE
- 7. ROSCA DE FIXAÇÃO COM ANILHAS
FIXING NUT WITH RINGS
- 8. LIMITADOR DO TRAVESSÃO
LIMITER YOKE
- 9. PARAFUSO CENTRAL
CENTRE AXIS
- 10. VÁLVULA DE REGULAÇÃO
CONTROL VALVE
- 11. VÁLVULA DE SEGURANÇA
SAFETY VALVE
- 12. SUPORTE DA VÁLVULA DE REGULAÇÃO
CONTROL VALVE SUPPORT
- 13. RODELA
RING
- 14. ASA LATERAL EM BAQUELITE
BAKELITE SIDE HANDLE
- 15. JUNTA DE VEDAÇÃO LABIAL EM BORRACHA
RUBBER SEALING RING
- 16. CESTO INTERIOR EM ALUMÍNIO (OPCIONAL)
ALUMINIUM INNER BASKET (OPTIONAL)
- 17. PARAFUSO DE FIXAÇÃO DA ASA
HANDLE FIXING SCREW

TRADICIONAL

VERMELHA | RED

A TRADIÇÃO É INTEMPORAL
TRADITION IS TIMELESS

AÇO INOX
STAINLESS STEEL



CE

P.PRESSÃO S/CESTO INOX 220
PRESS.COOKER NO BASKET INOX 220

Diam.(cm)	Alt.(cm)	Capac.(L)	Artigo
Diam.(cm)	Hgh.(cm)	Capac.(L)	Article
22	16.9	6	64112L018760

Cor disponível apenas em tamanhos específicos
Colour available only for specific sizes

SACO SILAMPOS
SILAMPOS BAG



ESQUEMA | SCHEME

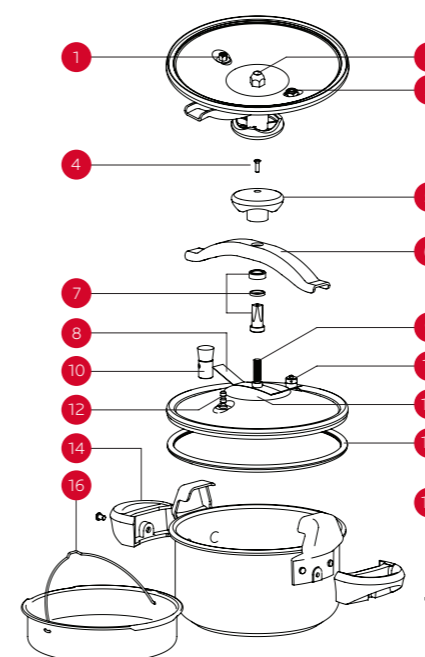

1. PORCA DA VÁLVULA DE REGULAÇÃO
SAFETY VALVE NUT
2. PORCA DO PARAFUSO CENTRAL
CENTRE AXIS NUT
3. PORCA DA VÁLVULA DE SEGURANÇA CONTROL
VALVE NUT
4. PARAFUSO DO BOTÃO DE APERTO M5X13
LOCKING LEVER SCREW M5X13
5. BOTÃO DE APERTO EM BAQUELITE
BAKELITE LOCKING LEVER
6. TRAVESSÃO EM AÇO INOXIDÁVEL
STAINLESS STEEL YOKE
7. ROSCA DE FIXAÇÃO COM ANILHAS
FIXING NUT WITH RINGS
8. LIMITADOR DO TRAVESSÃO
LIMITER YOKE
9. PARAFUSO CENTRAL
CENTRE AXIS
10. VÁLVULA DE REGULAÇÃO
CONTROL VALVE
11. VÁLVULA DE SEGURANÇA
SAFETY VALVE
12. SUPORTE DA VÁLVULA DE REGULAÇÃO
CONTROL VALVE SUPPORT
13. RODELA
RING
14. ASA LATERAL EM BAQUELITE
BAKELITE SIDE HANDLE
15. JUNTA DE VEDAÇÃO LABIAL EM BORRACHA
RUBBER SEALING RING
16. CESTO INTERIOR EM ALUMÍNIO (OPCIONAL)
ALUMINIUM INNER BASKET (OPTIONAL)
17. PARAFUSO DE FIXAÇÃO DA ASA
HANDLE FIXING SCREW



JUNTA VEDAÇÃO
BORRACHA 220 mm
RUBBER SEALING RING
220 mm

Artigo
Article
621000019947 Pack
621000019966 Individual

Legenda 15
Subtitle



**JUNTA VEDAÇÃO
BORRACHA 245 mm
RUBBER SEALING
RING 245 mm**

Artigo
Article
621000019945 Pack
621000019964 Individual

Legenda 15
Subtitle



**JUNTA VEDAÇÃO
BORRACHA 280 mm
RUBBER SEALING
RING 280 mm**

Artigo
Article
64D000019901 Individual

Legenda 15
Subtitle



**CESTO INTERIOR EM
ALUMÍNIO 220/245
ALUMINIUM INNER
BASKET**

Diam.(cm) **Artigo**
Diam.(cm) Article
22 621000019913
24.5 622000019913

Legenda 16
Subtitle



**VÁLVULA DE SEGURANÇA
SAFETY VALVE**

Artigo
Article
621000019944 Pack
621000019963 Individual

Legenda 11 3
Subtitle



**CONJ. VÁLVULA
REGULAÇÃO + SUPORTE
CONTROL VALVE +
SUPPORT SET**

Artigo
Article
621000019941 Pack
621000019961 Individual

Legenda 10 12
Subtitle



**CONJUNTO ASA
+ PARAFUSO
SIDE HANDLE + SCREW SET**

Artigo
Article
621000019950 Pack
621000019969 Individual

Legenda 14 17
Subtitle



**BOTÃO APERTO
EM BAQUELITE
BAKELITE LOCKING LEVER**

Artigo
Article
621000019940A Pack
621000019960 Individual

Legenda 5
Subtitle



**CONJ. PARAFUSO CENTRAL
CENTRE AXIS SET**

Artigo
Article
621000019943A Pack
621000019962 Individual

Legenda 2 4 7 9
Subtitle



TRADICIONAL

A TRADICIONAL É INTEMPORAL
TRADITIONAL IS TIMELESS

ALUMÍNIO
ALUMINIUM



SACO SILAMPOS
SILAMPOS BAG



P.PRESSÃO C/CESTO ALM.220
PRESS.COOKER W/BASKET ALM. 220

Diam.(cm)	Alt.(cm)	Capac.(L)	Artigo
Diam.(cm)	Hgh(cm)	Capac.(L)	Article
22	12.6	4.5	621002018645
22	16.5	6	621002018660
22	21.8	8	621002018680

P.PRESSÃO C/CESTO ALM.245
PRESS.COOKER W/BASKET ALM.245

Diam.(cm)	Alt.(cm)	Capac.(L)	Artigo
Diam.(cm)	Hgh(cm)	Capac.(L)	Article
24.5	17.7	8	622002018608
24.5	21.9	10	622002018610
24.5	26.2	12	622002018612

P.PRESSÃO C/CESTO ALM.270
PRESS.COOKER W/BASKET ALM.270

Diam.(cm)	Alt.(cm)	Capac.(L)	Artigo
Diam.(cm)	Hgh(cm)	Capac.(L)	Article
27	32.5	18	623002018718
27	27.3	15	623002018715

ESQUEMA | SCHEME

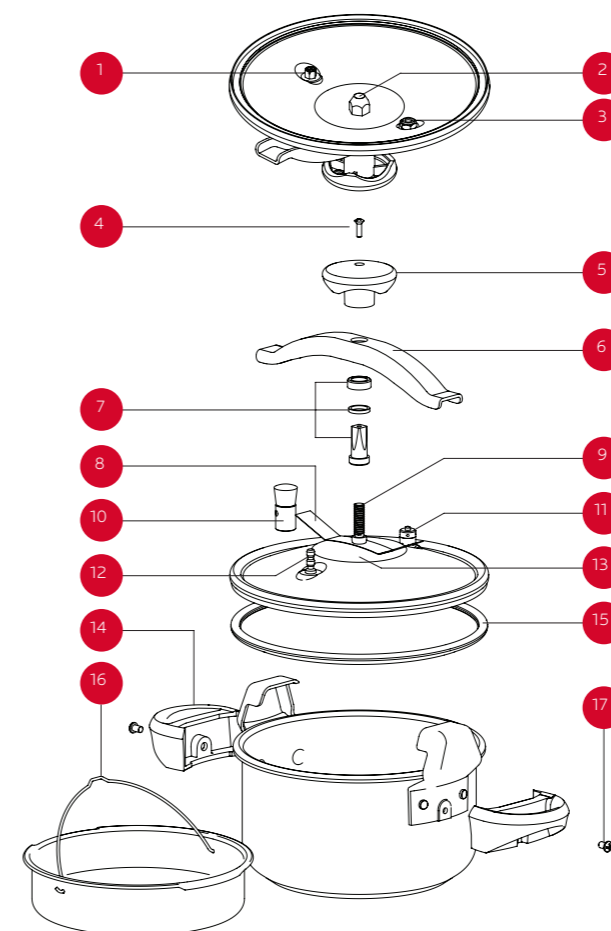

- 1. PORCA DA VÁLVULA DE REGULAÇÃO
SAFETY VALVE NUT
- 2. PORCA DO PARAFUSO CENTRAL
CENTRE AXIS NUT
- 3. PORCA DA VÁLVULA DE SEGURANÇA
CONTROL VALVE NUT
- 4. PARAFUSO DO BOTÃO DE APERTO M5X13
SCREW M5X13
- 5. BOTÃO DE APERTO EM BAQUELITE
BAKELITE LOCKING LEVER
- 6. TRAVESSÃO EM AÇO INOXIDÁVEL
STAINLESS STEEL YOKE
- 7. ROSCA DE FIXAÇÃO COM ANILHAS
FIXING NUT WITH RINGS
- 8. LIMITADOR DO TRAVESSÃO
LIMITER YOKE
- 9. PARAFUSO CENTRAL
CENTRE AXIS
- 10. VÁLVULA DE REGULAÇÃO
CONTROL VALVE
- 11. VÁLVULA DE SEGURANÇA
SAFETY VALVE
- 12. SUPORTE DA VÁLVULA DE REGULAÇÃO
CONTROL VALVE SUPPORT
- 13. RODELA
RING
- 14. ASA LATERAL EM BAQUELITE
BAKELITE SIDE HANDLE
- 15. JUNTA DE VEDAÇÃO LABIAL EM BORRACHA
RUBBER SEALING RING
- 16. CESTO INTERIOR EM ALUMÍNIO (OPCIONAL)
ALUMINIUM INNER BASKET (OPTIONAL)
- 17. PARAFUSO DE FIXAÇÃO DA ASA
HANDLE FIXING SCREW



BOTÃO APERTO
EM BAQUELITE
BAKELITE LOCKING LEVER

Artigo	Pack
621000019940A	Pack
621000019960	Individual

Legenda
Subtitle



CONJUNTO VÁLVULA
REGULAÇÃO + SUPORTE
CONTROL VALVE +
SUPPORT SET

Artigo	Pack
621000019941	Pack
621000019961	Individual

Legenda
Subtitle



**CONJUNTO ASA +
PARAFUSO 220
SIDE HANDLE
+ SCREW SET 220**

Artigo
Article
621000019950 Pack
621000019969 Individual

Legenda 14 17
Subtitle



**JUNTA VEDAÇÃO
BORRACHA 270
RUBBER SEALING
RING 270**

Artigo
Article
623000019902 Individual

Legenda 14
Subtitle



**JUNTA VEDAÇÃO
BORRACHA 220
RUBBER SEALING
RING 220**

Artigo
Article
621000019946 Pack
621000019965 Individual

Legenda 14
Subtitle



**JUNTA VEDAÇÃO
BORRACHA 245
RUBBER SEALING
RING 245**

Artigo
Article
621000019945 Pack
621000019964 Individual

Legenda 15
Subtitle



**CONJ. PARAFUSO CENTRAL
CENTRE AXIS SET**

Artigo
Article
621000019943A Pack
621000019962 Individual

Legenda 2 7 9
Subtitle



**VÁLVULA SEGURANÇA
SAFETY VALVE**

Artigo
Article
621000019944 Pack
621000019963 Individual

Legenda 11
Subtitle



**CESTO INTERIOR EM
ALUMÍNIO 220/245
ALUMINIUM INNER BASKET**

Diam.(cm) Artigo
Diam.(cm) Article
22 621000019913
24.5 622000019913

Legenda 16
Subtitle



EASY

COZINHE RÁPIDA E FACILMENTE
MAKE IT QUICK AND SIMPLE

É fácil de manusear, está equipada com um conjunto de elementos de pega ergonomicamente sobrepostos possibilitando o seu manuseamento com uma só mão, inclui ainda uma pega de apoio que facilita o seu transporte. A junta de vedação em silicone permite a abertura/fecho da tampa de uma forma rápida e sem esforço. Fácil de cozinhar, com duas pressões de funcionamento cabendo ao utilizador a escolha da mais adequada ao alimento a confeccionar. Fácil de limpar, em aço inoxidável e baquelite, pode ser lavada na máquina de lavar louça, bastando para o efeito retirar apenas a junta de vedação. Disponível nas seguintes capacidades: 4L, 6L e 7,5L.

Equipped with one set of ergonomic handles, it is easy to use, and can be hold with one hand only. An additional handle helps moving it from one point to another. The silicone sealing ring allows lid opening/closing with no effort, in a very easy way. It makes cooking easier with two pressure levels, enabling the user to select the most appropriate level according to the type of food. Easy to clean, made out of stainless steel and bakelite, it is dishwasher safe, once the sealing ring is removed. Available in the following capacities: 4L, 6L and 7,5L.



PANELA DE PRESSÃO PRESSURE COOKER

Diam.(cm)	Alt.(cm)	Capac.(L)	Artigo
Diam.(cm)	Hgh.(cm)	Capac.(L)	Article
Ø 22	10.6	4	644122018740
Ø 22	15.8	6	644122018760
Ø 22	20	7.5	644122018775



ALGUNS ACESSÓRIOS
DISPONÍVEIS EM SACO
SOME SPARE PARTS
ARE AVAILABLE IN
INDIVIDUAL BAG

ESQUEMA | SCHEME

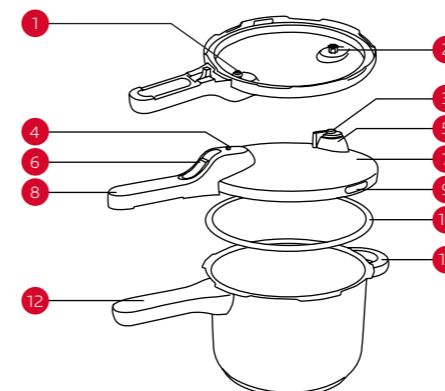

- 1. VÁLVULA DE SEGURANÇA
SAFETY VALVE
- 2. PORCA DA VÁLVULA DE REGULAÇÃO
CONTROL VALVE NUT
- 3. BOTÃO SELETOR
SELECTION BUTTON
- 4. INDICADOR DE PRESSÃO
PRESSURE INDICATOR
- 5. VÁLVULA DE REGULAÇÃO
CONTROL VALVE NUT
- 6. BOTÃO DE FECHO/ ABERTURA
OPEN/CLOSE BUTTON

- 7. TAMPa EM AÇO INOXIDÁVEL STAINLESS
STEEL LID
- 8. CABO DA TAMPa EM BAQUELITE BAKELITE
LID LONG HANDLE
- 9. JANELA DE SEGURANÇA
SAFETY WINDOW
- 10. JUNTA DE VEDAÇÃO EM SILICONE
SILICONE SEALING RING
- 11. ASA LATERAL EM BAQUELITE BAKELITE
SIDE HANDLE
- 12. CABO DO CORPO EM BAQUELITE
BAKELITE COOKER HANDLE



**CABO DO CORPO EM
BAQUELITE + PARAFUSO**
BAKELITE COOKER
HANDLE + SCREW

Artigo
Article
644000019901

Vendido em saco individual
Sold in individual bag

Legenda 12
Subtitle



**ASA LATERAL EM
BAQUELITE + PARAFUSO**
BAKELITE SIDE
HANDLE + SCREW

Artigo
Article
644000019902

Vendido em saco individual
Sold in individual bag

Legenda 11
Subtitle



JUNTA DE VEDAÇÃO EM SILICONE
SILICONE SEALING RING

Artigo
Article
644000019903

Vendido em saco individual
Sold in individual bag

Legenda 10
Subtitle



O-RING DA VÁLVULA DE SEGURANÇA
SAFETY VALVE O-RING

Artigo
Article
644000019930

Vendido em saco individual
Sold in individual bag



VÁLVULA DE REGULAÇÃO COMPLETA
COMPLETE CONTROL VALVE

Artigo
Article
644000019919

Vendido em saco individual
Sold in individual bag

Legenda 5
Subtitle



FAQUEIRO

CUTLERY SET

Lisbon



FAQUEIRO 24 PEÇAS 24 PIECES CUTLERY SET

Composição Composition	Artigo Article
6 Facas de Mesa Table Knives	415927012150
6 Garfos de Mesa Table Forks	
6 Colheres de Mesa Table Spoons	
6 Colheres de Chá Tea Spoons	



FAQUEIRO 48 PEÇAS 48 PIECES CUTLERY SET

Composição Composition	Artigo Article
6 Facas de Mesa Table Knives	415927012155
6 Garfos de Mesa Table Forks	
6 Colheres de Mesa Table Spoons	
6 Colheres de Chá Tea Spoons	
6 Facas de Sobremesa Dessert Knives	
6 Garfos de Sobremesa Dessert Forks	
6 Colheres de Sobremesa Dessert Spoons	
6 Colheres de Café Coffee Spoons	

ARROZ DE CAMARÃO, TOMATE, AIPO E HORTELÃ

PRAWN, TOMATOES, CELERY AND MINT RICE.

10 PESSOAS

INGREDIENTES

1,5kgs de camarão 20/30
600g de arroz carolino
5 dentes de alho picado
180g de cebola aos cubos
200g de talos de aipo em juliana
200g de creme de tomate assado
1dl de vinho branco
1,5dl de azeite virgem extra
1 folha de louro
Caldo de camarão (q.b.)
Sumo de limão (q.b.)
10 folhas de hortelã em folha
2 c.sopa salsa folha
Sal marinho tradicional
Pimenta de moinho

CONFEÇÃO

Tempere o camarão com sal grosso e deixe repousar durante 20 minutos.
Aloure em azeite o alho, a cebola, o louro e refresque com vinho branco. Junte o arroz e deixe suar breves momentos, junte o caldo e deixe cozinhar.
No meio da cozedura do arroz, adicione o aipo.
Quando o arroz ainda estiver praticamente cozinhado adicione o camarão.
Deixe ferver mais 3 ou 4 minutos, rectifique temperos e envolva o preparado com o creme de tomate assado. Perfume com a hortelã, a salsa e o sumo de limão.

10 PERSONS

INGREDIENTS

1.5 kg Peeled prawns
600 g Carolino rice
5 cloves of Garlic
180 g diced onion
200g celery, julienned
200g roasted tomato sauce
100 ml Extra virgin olive oil
100 ml White wine
1 Bay leaf
Prawn stock (As needed)
Lemon juice (As needed)
10 leaves Fresh mint
2 tbsp Fresh parsley
Traditional sea salt
Ground pepper

METHOD

Season the prawns with salt and leave for 20 minutes.
Sauté garlic, onion and bay leaf in olive oil and de glaze with white wine. Add the rice and briefly let it sweat, then add the stock and leave to cook.
When the rice is half cooked, add the celery.
When the rice is almost cooked, add the prawns.
Simmer for another 3 or 4 minutes, season to taste and stir through the roasted tomato sauce.
Flavour with the mint, parsley and lemon juice.

CREME DE TOMATE ASSADO

600g Cebola em cubos
350g Tomate pelado em cubos
50ml Vinho branco
50ml Azeite virgem extra
Sal marinho tradicional(q.b.)

Coloque a cebola e o tomate num tabuleiro de forno e tempere com os restantes ingredientes. Leve a assar em forno aquecido a 150° tapado com folha de alumínio durante 40 minutos. Triture no liquidificador e reserve.

ROASTED TOMATO

100g Onion, diced
350g Peeled tomato, diced
50ml White wine
50ml Extra virgin olive oil
(As needed) Traditional sea salt

Place the onions and tomatoes on a baking tray and season with the remaining ingredients. Bake in oven heated to 150°C covered with aluminium foil for 40 minutes. Liquify in a blender and set aside.





Rua das Cortinhas, 301
Apartado 2004
3701 - 906 Cesar
Portugal

Tel: (+351) 256 850 400
(chamada para a rede fixa nacional)
Email: geral@silampos.pt
www.silampos.pt

COMPETE
2030

PORTUGAL
2030



Cofinanciado pela
União Europeia