



PRIMA COLLECTION

2026



INDICE

INDEX

POSATE / CUTLERY

Bell.....	15
Country.....	30
Daisy.....	28
Derby.....	11
Dinner.....	14
Dover.....	19
Drop.....	36
Drop Satin.....	38
Duke Satin.....	32
Easy.....	7
Eat.....	20
Flavia.....	10
Galles.....	16
Lunch.....	4
Marina.....	12
Marina Vibrato.....	8
Milano.....	17
Monaco.....	13
Nice.....	3
Ponza.....	24
Princess.....	34
Sea.....	6
Venezia.....	18
Versilia.....	9
Villa.....	22
Villa Satin.....	23
Accessori/Accessories.....	41
Confezioni posate / Cutlery packaging.....	27
Prima set oliere / Cruet set	42
Set coltelli / Knives set.....	40

COTTURA / COOKWARE

Comfort.....	52
Cook-it.....	61
Ecoline.....	46
First.....	54
First pent. pressione / Pressure cooker.....	55
Inox Plus.....	50
Pop	58
Pop Extra.....	60
Portofino.....	65
Smart set padelle / Frying pan set.....	64
Tender Alu Easy	56
X-Black	62

GASTRONORM

GN-P.....	67
-----------	----

UTENSILI DA CUCINA / KITCHEN TOOLS

Gadget Fast.....	71
Gadget FPR.....	74
Smart.....	78



NICE

004

18/0





mm 1,5



SOLO VENDITA MASTER
ONLY MASTER SELLING



Chiave
(master pcs 24)

		cod. chiave	cm cutlery	Euro chiave
x3		AW301	19,0	2,50
x3		AW302	19,0	2,50
x2		AW2L3	21,5	2,50
x4		AW407	14,0	2,50
x4		AW417	14,0	2,50

LUNCH







296

18/0

UDV 12 pz

mm 1,8

Confezione 12 pz / 12 pcs box

	cod.	Euro 1 pcs
	00001	0,94
	00002	0,94
	000L3	2,28
	000F3	3,74
	000F7	3,96
	00007	0,76
	00017	0,84





SEA R02





18/0
UDV 120 pz
mm 1,5

Set posate / Cutlery set

cod.	set	Euro
0E2SN	16 pcs	24,32
0E291	24 pcs	33,36

**SOLO VENDITA MASTER
ONLY MASTER SELLING**

Master pcs 120





	cod. master	Euro master	Euro 1 pcs
	0M001	131,36	1,09
	0M002	131,36	1,09
	0M0L3	185,18	1,54
	0M007	96,62	0,80



**SOLO VENDITA MASTER
ONLY MASTER SELLING**



Chiave
(master pcs 24)

	cod. chiave	cm cutlery	Euro chiave
x3 	HW301	19,7	4,16
x3 	HW302	20,0	4,16
x2 	HW2L3	21,3	4,10
x6 	HW607	13,0	5,82

EASY

124

18/0

UDV 12 pz





mm 1,5



Set posate / Cutlery set

cod.	set	Euro
0E2SN	16 pcs	23,92
0E291	24 pcs	32,76





Confezione 12 pz / 12 pcs box

	cod.	Euro 1 pcs
	00001	1,18
	00002	1,18
	000L3	1,24
	00007	0,82
	00017	0,82

SOLO VENDITA MASTER
ONLY MASTER SELLING



Valva
(master pcs 10)





	cod. valva	Euro valva
x24 	0\$Q01	25,48
x24 	0\$Q02	25,48
x12 	0\$HL3*	33,54
x36 	0\$B07	25,48
x36 	0\$B17	25,48

*lamin. 3,8 mm

SOLO VENDITA MASTER
ONLY MASTER SELLING



Chiave
(master pcs 24)

	cod. chiave	cm cutlery	Euro chiave
x3 	EW301	19,0	4,34
x3 	EW302	19,0	4,34
x2 	EW2L3	20,9	3,42
x6 	EW607	13,7	5,62
x6 	EW417	13,6	5,62

MARINA VIBRATO

117

18/0

UDV 240 pz







mm 1,8

Set posate / Cutlery set

cod.	set	Euro
1E2SN	16 pcs	24,48
1E291	24 pcs	33,60

**SOLO VENDITA MASTER
ONLY MASTER SELLING**

Master pcs 240







	cod. master	Euro master	Euro 1 pcs
	1M001	303,66	1,26
	1M002	303,66	1,26
	1M0L3	311,88	1,29
	1M004	250,86	1,04
	1M005	250,86	1,04
	1M007	180,50	0,75
	1M008	164,08	0,68



**SOLO VENDITA MASTER
ONLY MASTER SELLING**



Chiave
(master pcs 24)

	cod. chiave	cm cutlery	Euro chiave
x3 	KW301	19,7	4,70
x3 	KW302	20,0	4,70
x2 	KW2L3	21,0	3,54
x3 	KW304	18,5	4,00
x3 	KW305	18,7	4,00
x6 	KW607	13,0	5,42
x6 	KW608	11,2	5,00

VERSILIA

102

18/0

UDV 12 pz

mm 1,5

Set posate / Cutlery set

cod.	set	Euro
0E2SN	16 pcs	34,72
0E291	24 pcs	48,96

Confezione 12 pz / 12 pcs box





	cod.	Euro 1 pcs
	00001	1,30
	00002	1,30
	000L3	3,70
	00007	0,82



SOLO VENDITA MASTER
ONLY MASTER SELLING



Chiave
(master pcs 24)

	cod. chiave	cm cutlery	Euro chiave
x3 	EW301	19,7	5,00
x3 	EW302	19,2	5,00
x2 	EW2L3	22,0	8,14
x6 	EW607	12,5	5,98

FLAVIA

109

18/0





UDV 12 pz

mm 1,5

Set posate / Cutlery set

cod.	set	Euro
0E2SN	16 pcs	34,72
0E291	24 pcs	48,96

Confezione 12 pz / 12 pcs box





	cod.	Euro 1 pcs
	00001	1,30
	00002	1,30
	000L3	3,70
	00007	0,82



SOLO VENDITA MASTER
ONLY MASTER SELLING



Chiave
(master pcs 24)

	cod. chiave	cm cutlery	Euro chiave
x3	 EW301	19,5	5,00
x3	 EW302	19,5	5,00
x2	 EW2L3	22,2	8,14
x6	 EW607	12,5	5,98

DERBY

R03

18/0

UDV 120 pz









mm 2,0

Set posate / Cutlery set

cod.	set	Euro
0E2SN	16 pcs	29,08
0E291	24 pcs	40,50

**SOLO VENDITA MASTER
ONLY MASTER SELLING**

Master pcs 120

	cod. master	Euro master	Euro 1 pcs
	0M001	159,08	1,32
	0M002	159,08	1,32
	0M0L3	262,72	2,18
	0M0F3	448,80	3,74
	0M004	148,44	1,23
	0M005	148,44	1,23
	0M0L6	248,88	2,07
	0M007	107,10	0,89
	0M008	93,38	0,77



**SOLO VENDITA MASTER
ONLY MASTER SELLING**



Chiave

(master pcs 24)

	cod. chiave	cm cutlery	Euro chiave
x3	FW301	19,6	4,86
x3	FW302	19,6	4,86
x2	FW2L3	22,0	5,38
x3	FW304	17,8	4,68
x3	FW305	17,7	4,68
x2	FW2L6	19,4	5,06
x6	FW607	14,1	6,28
x6	FW608	11,5	5,64

MARINA

117

18/0

UDV 240 pz









mm 1,8

Set posate / Cutlery set

cod.	set	Euro
0E2SN	16 pcs	32,16
0E291	24 pcs	45,12

**SOLO VENDITA MASTER
ONLY MASTER SELLING**

Master pcs 240

	cod. master	Euro master	Euro 1 pcs
	0M001	352,96	1,47
	0M002	352,96	1,47
	0M0L3	640,14	2,66
	0M004	328,32	1,36
	0M005	328,32	1,36
	0M007	213,34	0,88
	0M008	188,72	0,78
	0M017	238,04	0,99



**SOLO VENDITA MASTER
ONLY MASTER SELLING**



Chiave
(master pcs 24)

	cod. chiave	cm cutlery	Euro chiave
x3	HW301	19,7	5,30
x3	HW302	20,0	5,30
x2	HW2L3	21,0	6,36
x3	HW304	18,5	4,98
x3	HW305	18,7	4,98
x6	HW607	13,0	6,28
x6	HW608	11,2	5,64
x6	HW617	14,7	6,84

MONACO

174

18/0

UDV 120 pz











mm 1,8

Set posate / Cutlery set

cod.	set	Euro
0E2SN	16 pcs	33,76
0E291	24 pcs	47,52

**SOLO VENDITA MASTER
ONLY MASTER SELLING**

Master pcs 120











	cod. master	Euro master	Euro 1 pcs
	0M001	178,34	1,48
	0M002	178,34	1,48
	0M0L3	326,98	2,72
	0M004	172,74	1,43
	0M005	172,74	1,43
	0M0L6	314,14	2,61
	0M007	144,94	1,20
	0M008	123,58	1,02
	0M017	144,94	1,20
	0M036	177,22	1,47



**SOLO VENDITA MASTER
ONLY MASTER SELLING**



Chiave
(master pcs 24)

	cod. chiave	cm cutlery	Euro chiave
x3	 GW301	19,6	5,34
x3	 GW302	19,6	5,34
x2	 GW2L3	20,8	6,36
x3	 GW304	18,5	5,20
x3	 GW305	18,5	5,20
x2	 GW2L6	19,7	6,10
x6	 GW607	13,0	8,10
x6	 GW608	11,3	7,06
x6	 GW617	15,0	8,10
x6	 GW636	21,0	9,72

DINNER R04







18/0
UDV 120 pz
mm 2,0

Set posate / Cutlery set

cod.	set	Euro
0E2SN	16 pcs	31,24
0E291	24 pcs	43,74

**SOLO VENDITA MASTER
ONLY MASTER SELLING**

Master pcs 120





	cod. master	Euro master	Euro 1 pcs
	0M001	182,76	1,52
	0M002	182,76	1,52
	0M0L3	272,80	2,27
	0M0F3	448,80	3,74
	0M0F7	475,20	3,96
	0M007	113,68	0,94



**SOLO VENDITA MASTER
ONLY MASTER SELLING**



Chiave
(master pcs 24)

	cod. chiave	cm cutlery	Euro chiave
x3 	HW301	20,0	5,48
x3 	HW302	20,0	5,48
x2 	HW2L3	22,0	5,56
x6 	HW607	14,2	6,58

BELL 144

18/0

UDV 120 pz





mm 1,5

Set posate / Cutlery set

cod.	set	Euro
0E2SN	16 pcs	33,36
0E291	24 pcs	46,92

**SOLO VENDITA MASTER
ONLY MASTER SELLING**

Master pcs 120





	cod. master	Euro master	Euro 1 pcs
	0M001	182,42	1,52
	0M002	182,42	1,52
	0M0L3	323,28	2,69
	0M007	126,32	1,05



**SOLO VENDITA MASTER
ONLY MASTER SELLING**



Chiave
(master pcs 24)

	cod. chiave	cm cutlery	Euro chiave
x3 	FW301	19,6	5,48
x3 	FW302	19,5	5,48
x2 	FW2L3	21,3	6,36
x6 	FW607	14,0	7,36

GALLES

089

18/10

UDV 12 pz









mm 1,8



Set posate / Cutlery set

cod.	set	Euro
XE2SN	16 pcs	38,88
XE291	24 pcs	55,20

Confezione 12 pz / 12 pcs box

	cod.	Euro 1 pcs
	X0001	1,74
	X0002	1,74
	X00L3	3,52
	X00F3	3,74
	X0005	1,74
	X00L6	3,18
	X0007	1,16
	X0008	0,96
	X0017	1,30









Sfuso / Single pieces

	cod.	cm cutlery	Euro 1 pcs
	X0010	26,8	16,44
	X0011	21,8	5,98
	X0012	21,6	5,98
	X0020	23,4	6,80

SOLO VENDITA MASTER
ONLY MASTER SELLING



Chiave
(master pcs 24)

	cod. chiave	cm cutlery	Euro chiave
x3	 GW301	21,0	6,28
x3	 GW302	21,0	6,28
x2	 GW2L3	22,0	7,62
x3	 GW305	17,6	6,20
x2	 GW2L6	19,6	7,24
x6	 GW607	15,2	7,78
x6	 GW608	11,6	6,66
x6	 GW617	15,2	8,64

MILANO

R10

18/10

UDV 120 pz





mm 2,2

Set posate / Cutlery set

cod.	set	Euro
0E2SN	16 pcs	38,44
0E291	24 pcs	54,54

**SOLO VENDITA MASTER
ONLY MASTER SELLING**

Master pcs 120





	cod. master	Euro master	Euro 1 pcs
	0M001	237,58	1,97
	0M002	237,58	1,97
	0M0L3	320,34	2,66
	0M007	174,80	1,45



**SOLO VENDITA MASTER
ONLY MASTER SELLING**



Chiave
(master pcs 24)

	cod. chiave	cm cutlery	Euro chiave
x3 	CW301	19,5	6,86
x3 	CW302	19,5	6,86
x2 	CW2L3	21,5	6,16
x6 	CW607	14,0	9,62

ENEZIA

R08

18/10

UDV 120 pz





mm 2,2

Set posate / Cutlery set

cod.	set	Euro
0E2SN	16 pcs	38,32
0E291	24 pcs	54,36

**SOLO VENDITA MASTER
ONLY MASTER SELLING**

Master pcs 120





	cod. master	Euro master	Euro 1 pcs
	0M001	241,38	2,01
	0M002	241,38	2,01
	0M0L3	320,34	2,66
	0M007	161,70	1,34



**SOLO VENDITA MASTER
ONLY MASTER SELLING**



Chiave
(master pcs 24)

	cod. chiave	cm cutlery	Euro chiave
x3 	CW301	19,5	6,86
x3 	CW302	19,5	6,86
x2 	CW2L3	21,5	6,16
x6 	CW607	13,3	9,62

DOVER R11

18/0

UDV 120 pz













mm 2,5

Set posate / Cutlery set

cod.	set	Euro
0E0SN	16 pcs	49,12
0E091	24 pcs	70,56

**SOLO VENDITA MASTER
ONLY MASTER SELLING**

Master pcs 120











	cod. master	Euro master	Euro 1 pcs
	0M001	296,10	2,46
	0M002	296,10	2,46
	0M003	560,04	4,66
	0M0F3	448,80	3,74
	0M067	544,46	4,53
	0M004	207,40	1,72
	0M005	207,40	1,72
	0M006	536,18	4,46
	0M007	136,84	1,14
	0M008	126,96	1,05
	0M017	136,84	1,14
	0M036	211,68	1,76



**SOLO VENDITA MASTER
ONLY MASTER SELLING**



Chiave
(master pcs 24)

	cod. chiave	cm cutlery	Euro chiave
x3	 BW301	20,2	8,22
x3	 BW302	20,5	8,22
x2	 BW203	23,5	10,32
x2	 BW267	22,5	10,02
x3	 BW304	17,8	6,04
x3	 BW305	17,7	6,04
x2	 BW206	21,5	9,78
x6	 BW607	14,0	7,78
x6	 BW608	12,2	7,16
x6	 BW617	15,1	7,78
x6	 BW636	21,0	11,40

EAT 257









18/10
UDV 12 pz
mm 1,8



Set posate / Cutlery set

cod.	set	Euro
0E0SN	16 pcs	40,48
0E091	24 pcs	57,60







Confezione 12 pz / 12 pcs box

	cod.	Euro 1 pcs
	00001	1,84
	00002	1,84
	00003	3,74
	00007	1,14
	00008	1,02
	00017	1,36
	00067	3,96
	00051	3,96

SOLO VENDITA MASTER
ONLY MASTER SELLING









Valva
(master pcs 10)

	cod. valva	Euro valva
x12 	0\$H01	24,10
x12 	0\$H02	24,10
x6 	0\$603	24,10
x20 	0\$U07	24,10
x18 	0\$\$17	24,10
x6 	0\$651	24,10

SOLO VENDITA MASTER
ONLY MASTER SELLING



Chiave
(master pcs 24)

	cod. chiave	cm cutlery	Euro chiave
x3 	LW301	20,1	6,24
x3 	LW302	19,9	6,24
x2 	LW203	21,8	8,34
x6 	LW607	14,2	7,60
x6 	LW608	11,5	6,90
x6 	LW617	15,5	8,94



VILLA 255

18/10

UDV 12 pz













mm 2,5

Set posate / Cutlery set

cod.	set	Euro
0E0SN	16 pcs	58,32
0E091	24 pcs	84,36

Confezione 12 pz / 12 pcs box













	cod.	Euro 1 pcs
	00001	2,84
	00002	2,84
	00003	5,64
	000F3	3,74
	000F7	3,96
	00004	2,82
	00005	2,82
	00006	5,56
	000F6	3,54
	00007	1,70
	00008	1,44
	00017	1,80
	00029	2,84

SOLO VENDITA MASTER
ONLY MASTER SELLING



Chiave
(master pcs 24)

	cod. chiave	cm cutlery	Euro chiave
x3	 CW301	20,9	9,36
x3	 CW302	20,8	9,36
x2	 CW203	23,0	12,10
x3	 CW304	18,0	9,26
x3	 CW305	18,0	9,26
x2	 CW206	21,0	11,94
x6	 CW607	14,5	10,98
x6	 CW608	11,1	9,44
x6	 CW617	15,6	11,60
x3	 CW329	20,0	9,36

VILLA SATIN

255

18/10

UDV 12 pz











mm 2,5



Set posate / Cutlery set

cod.	set	Euro
UE0SN	16 pcs	58,32
UE091	24 pcs	84,36

Confezione 12 pz / 12 pcs box

	cod.	Euro 1 pcs
	U0001	2,84
	U0002	2,84
	U0003	5,64
	U0004	2,82
	U0005	2,82
	U0006	5,56
	U0007	1,70
	U0008	1,44
	U0017	1,80
	U0029	2,84

PONZA

256

18/10

UDV 12 pz











mm 2,5







Set posate / Cutlery set

cod.	set	Euro
0E0SN	16 pcs	61,04
0E091	24 pcs	88,44

Confezione 12 pz / 12 pcs box

	cod.	Euro 1 pcs
	00001	3,16
	00002	3,16
	00003	5,64
	00004	3,12
	00005	3,12
	00006	5,60
	00007	1,74
	00008	1,34
	00017	1,64
	00029	2,96











Sfuso / Single pieces

	cod.	Euro 1 pcs
	00010	18,92
	00011	8,22
	00012	8,22
	00013	10,74

SOLO VENDITA MASTER
ONLY MASTER SELLING



Chiave
(master pcs 24)

	cod. chiave	cm cutlery	Euro chiave
x3	 GW301	20,3	10,22
x3	 GW302	20,1	10,22
x2	 GW203	22,8	12,10
x3	 GW304	18,0	10,12
x3	 GW305	18,0	10,12
x2	 GW206	21,0	12,06
x6	 GW607	14,0	11,14
x6	 GW608	11,7	8,78
x6	 GW617	15,4	10,80
x3	 GW329	20,5	9,72



CONFEZIONI
PACKAGING

CONFEZIONI POSATE CUTLERY PACKAGING

Ecobox 16/24 pz
Ecobox 16/24 pcs
cod. 92032020
Euro 6,24



Confezione 12 pz
Box 12 pcs

cod.	descriz.	Euro
90515000	confezione grande <i>large box</i>	0,68
90515001	confezione piccola <i>small box</i>	0,46









DAISY

2G_07091

18/0 + ABS
SET 24 PCS



cod.	colour	Euro
A	 BLACK	30,20
B	 WHITE	30,20
C	 BLUE	30,20
D	 SAND	30,20
E	 GREEN	30,20
F	 RED	30,20









COUNTRY

2F_07091

18/0 + ABS
SET 24 PCS



cod.	colour	Euro
A	 WOOD	32,76
B	 BLACK	32,76
C	 GREY	32,76
D	 GREEN	32,76









DUKE SATIN

2K_U7091

18/0



SET 24 PCS

mm 3,0

cod.	colour	Euro
O	 STEEL	41,50
R	 SUN	47,96
S	 AMBER	48,88
T	 CARBON	56,58



Confezione 12 pz
12 pcs box

cod.	colour	Euro
2KRU0001		2,00
2KRU0002		2,00
2KRU0003		2,90
2KRU0007	SUN	1,90
2KSU0001		2,00
2KSU0002		2,00
2KSU0003		2,90
2KSU0007	AMBER	1,90
2KTU0001		2,40
2KTU0002		2,40
2KTU0003		3,30
2KTU0007	CARBON	2,30



PRINCESS





2C_07091

18/0

SET 24 PCS

mm 3,0





cod.	colour	Euro
0	 STEEL	46,90
R	 SUN	54,88
S	 AMBER	56,12
T	 CARBON	64,50
U*	 RAINBOW	54,40

* In esaurimento / Discontinued



Confezione 12 pz
12 pcs box

cod.	colour	Euro
2CR00001		2,26
2CR00002		2,26
2CR00003		2,42
2CR00007	SUN	2,14
2CS00001		2,36
2CS00002		2,36
2CS00003		2,50
2CS00007	AMBER	2,22
2CT00001		2,68
2CT00002		2,68
2CT00003		2,80
2CT00007	CARBON	2,48





DROP

28500091



Euro 34,90

18/0

SET 24 PCS

mm 2,0

design Marcello Ziliani





DROP SATIN

28_U0091





18/0

SET 24 PCS

mm 2,0

design Marcello Ziliani

cod.	colour	Euro
5	 STEEL	34,90
R	 SUN	38,90
T	 CARBON	46,90





SET COLTELLI

KNIVES SET

Coltello pizza (cm 20,5)

Pizza knife

cod. 74600...



cod.	descriz.	Euro pack.
P51	scatola bianca 12 pz / 12 pcs set white box	8,50
651	blister 6 pz / blister 6 pcs	4,80



Coltello tavola (cm 21,7)

Table knife

cod. 74600...

cod.	descriz.	Euro pack.
PEK	scatola bianca 12 pz / 12 pcs set white box	8,50
6EK	blister 6 pz / blister 6 pcs	4,80



Coltello bistecca (cm 22,2)

Steak knife

cod. 74600...

cod.	descriz.	Euro pack.
PEU	scatola bianca 12 pz / 12 pcs set white box	13,56
6EU	blister 6 pz / blister 6 pcs	8,40



Coltello bistecca punta tonda (cm 22,2)

Steak knife rounded tip

cod. 74600...

cod.	descriz.	Euro pack.
PFU	scatola bianca 12 pz / 12 pcs set white box	14,06
6FU	blister 6 pz / blister 6 pcs	8,40



Coltello bistecca con manico effetto legno (cm 22,2)

Steak knife with wooden handle effect

cod. 7460L...

cod.	descriz.	Euro pack.
PEU	scatola bianca 12 pz / 12 pcs set white box	19,66
6EU	blister 6 pz / blister 6 pcs	9,36



Coltello bistecca punta tonda con manico effetto legno (cm 22,2)

Steak knife rounded tip with wooden handle effect

cod. 7460L...

cod.	descriz.	Euro pack.
PFU	scatola bianca 12 pz / 12 pcs set white box	19,66
6FU	blister 6 pz / blister 6 pcs	9,36



ACCESSORI ACCESSORIES

Forbice da cucina

Kitchen scissor

cod. 58174620

Euro 3,68



Cavatappi

Corkscrew

cod. 50916200

Euro 7,40



Cavatappi professionale

Professional corkscrew

cod. 58174300

Euro 2,88



OLIERE PRIMA

5717

18/0 + vetro/glass

Sistema salvagoccia

Non-leaking system

Articoli venduti in scatola litografata

Articles are packed in lithographed box



Set oliera 5 posti / 5 pcs cruet set

cod. 57175205

ml	cm	Euro
175 / 35	14x11x20	20,06



Set sale, pepe e stuzzicadenti / Salt, pepper and toothpick set

cod. 57177303

ml	cm	Euro
35	10x8,3x11,5	11,20



Formaggera / Cheese bowl

cod. 57173000

ml	cm	Euro
200	11x10x12,5	18,40



RICAMBI / SPARE PARTS

cod. 97200151 vetro per olio e aceto / oil and vinegar glass

cod. 97200152 vetro per sale e pepe / salt and pepper glass

cod. 97200153 vetro per stuzzicadenti / toothpick glass

cod. 97200150 vetro per formaggera / cheese bowl glass

cod. 97200154 tappo per olio / cup for oil and vinegar glass

cod. 97200155 tappo per sale e pepe / salt and pepper glass



COTTURA
COOKWARE

INOX
18/0

ECOLINE R500



MANICO IN ACCIAIO

STAINLESS STEEL HANDLE



INDUCTION

NICKEL
FREE



INOX
18/0

INOX PLUS R600



MANICO IN ACCIAIO CON FONDO
TERMODIFFUSORE

STAINLESS STEEL HANDLE WITH
THERMAL DIFFUSION BOTTOM



INDUCTION

NICKEL
FREE



INOX
18/0

COMFORT R650



MANICO IN BACHELITE CON
FONDO TERMODIFFUSORE

BAKELITE HANDLE WITH
THERMAL-DIFFUSION BOTTOM



INDUCTION

NICKEL
FREE



PRIMA COLLECTION

**LE SERIE DI
PENTOLAME
IN ACCIAIO
MADE IN
ITALY**

**MADE IN
ITALY
STAINLESS
STEEL
COOKWARE**

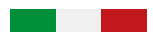

*Nickel Free
family*

1. Tutti gli articoli sono prodotti in Italia.
2. Tre serie complete:
ECOLINE: il miglior prezzo.
COMFORT: serie elegante con manici in bachelite.
INOX PLUS: ottimo rapporto qualità-prezzo.
3. Tutti gli articoli sono prodotti con acciai certificati e idonei al contatto alimentare secondo decreto legislativo DL 108 dt 25.01.92 e Dir. CEE 1935/2004 e 89/109.
4. Adatta a tutti i tipi di cucina, induzione compresa.
5. Bordo rinforzato.
6. Le maniglie e i manici sono ergonomici e in bachelite anticalore.
7. Packaging informativo dedicato.
8. Nickel Free.

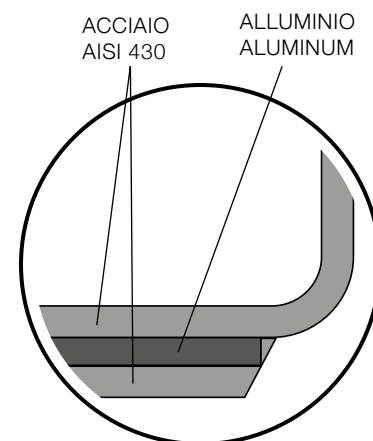

Fondo termodiffusore
*Thermal diffusion
 bottom*

1. 100% Made in Italy.
2. Three complete series.
ECOLINE: best value for money of the series.
COMFORT: Elegance series with Bakelite handles.
INOX PLUS: excellent price-quality ratio.
3. All stainless steel used in mass production is in conformity with DL 108 dated 25.01.92 & CEE 1935/2004 and 89/109 law.
4. Suitable for all kind of cooktops, including induction.
5. Reinforced edge.
6. Bakelite ergonomic handles and knobs, made to avoid heat contact.
7. Nice and dedicated packaging.
8. Nickel Free.



Maniglia in bachelite
Bakelite handles



Bordo rinforzato
Reinforced edge

ECOLINE R500

18/0

Made in Italy 

NICKEL
FREE



INDUZIONE
INDUCTION



GAS
GAS



CERAMICO
CERAMIC



ALOGENO
HALOGEN



ELETTRICO
ELECTRIC

Pentola / Pot cod. R50003..

Ø cm	h cm	Lt	Master	cm Master	kg Master	Euro
16	12	2,1	6	30x20x46	2,76	17,44
18	13	2,8	6	31x33,5x45	3,23	19,98
20	14,5	3,8	6	31x34x46	2,76	24,78
22	14,7	5	4	33x32,5x44	2,86	28,86
24	17,1	6,5	4	38x30x55	3,28	31,22
26	17,3	8,5	4	37x29x57	3,81	35,90
28	18	10,5	2	37x29x57	2,96	42,08



Casseroiua / Casserole cod. R50005..

Ø cm	h cm	Lt	Master	cm Master	kg Master	Euro
16	7,5	1,3	6	24x34x23	2,53	16,08
18	8	1,8	6	24x34x23	2,54	17,44
20	9,4	2,4	6	20x30x46	2,85	19,24
22	10,5	3,5	4	46x30x18	2,40	21,92
24	11,4	4,8	4	33x30x34	2,70	23,74
26	13	5,4	4	33x30x33	2,95	25,26
28	14	8	4	37x29x57	4,06	35,90



Tegame / Roasting pan cod. R50023..

Ø cm	h cm	Lt	Master	cm Master	kg Master	Euro
24	4,5	2	6	24x34x23	3,28	22,40
28	5	3,2	6	32x32x30	3,76	29,90



Cuoci asparagi / *Asparagus pot*
cod. R5000816

Ø cm	h cm	Lt	Euro
16	20,5	4	74,52



Casseruola ovale con coperchio / *Oval casserole with lid*
cod. R50016..

cm	h cm	Lt	Euro
28	9,5	3,6	43,76
32	11	5,8	59,68



Colabrodo / Colander
cod. R50067..

cm	Euro
14	14,32
16	15,74



Teglia rettangolare / *Rectangular roasting pan*
cod. R50004..

cm	h cm	Lt	Euro
25x18	5	2	19,08
30x22	5,5	3,4	21,96
35x26	6	5	29,48
40x28	6,2	6,5	35,82
45x32	7,9	10	59,52



Coperchio per teglia rettangolare / *Lid for rectangular roasting pan*
cod. R50028..

cm	Euro
25x18	14,74
30x22	17,32
35x26	21,36
40x28	25,28



Bollilatte / *Milkpot*
cod. R5006012

Ø cm	h cm	Lt	Master	cm Master	kg Master	Euro
12	9	0,9	6	16x27x22	1,4	13,22



Cuoci Prima / *Cuoci Prima pot*
cod. R5087720

Ø cm	h cm	Lt	Euro
20	12,4	3,7	41,94

In esaurimento / Discontinued



Casseruola 1 manico / *Saucepan*
cod. R50006..

Ø cm	h cm	Lt	Master	cm Master	kg Master	Euro
12	5	0,5	6	24x13x28	1,01	12,00
16	7,5	1,3	6	23x23x34	1,74	14,74



Padella / *Frying pan*
cod. R50025..

Ø cm	h cm	Lt	Master	cm Master	kg Master	Euro
24	4,5	2	12	46x30x18	5,68	24,04
28	5	3,2	6	30x44,5x32,5	3,50	32,90



Cestello vapore / *Steaming basket*
cod. R5009822

Ø cm	h cm	Master	cm Master	kg Master	Euro
22	10,5	4	31x20x46	2,33	23,02



Coperchio / *Lid*
cod. R50030..

Ø cm	Master	cm Master	kg Master	Euro
16	12	26x23x33,5	1,8	8,60
18	12	26x23x36	2,11	8,86
20	12	31x20x46	2,41	9,36
22	12	31x20x46	2,94	9,90
24	12	31,5x33,5x45	3,72	10,50
26	12	31x34x45,5	4,24	11,86
28	12	31x34x45,5	5,22	14,26





INOX PLUS R600

18/0

Con fondo termodiffusore.
With thermal diffusion bottom.

Made in Italy 

NICKEL
FREE



INDUZIONE
INDUCTION



GAS
GAS



CERAMICO
CERAMIC



ALOGENO
HALOGEN



ELETTRICO
ELECTRIC

Pentola / Pot cod. R60003..

Ø cm	h cm	Lt	Euro
16	12	2,1	27,34
18	13	2,8	31,00
20	14,5	3,8	34,70
22	14,7	5	38,74
24	17,1	6,5	41,06
26	17,3	8,5	47,44
28	18	10,5	55,64



Casseruola / Casserole cod. R60005..

Ø cm	h cm	Lt	Euro
16	7,5	1,3	25,12
18	8	1,8	28,30
20	9,4	2,4	31,94
22	10,5	3,5	35,62
24	11,4	4,8	37,86
26	13	5,4	42,58
28	14	8	51,06



Tegame / Roasting pan cod. R60023..

Ø cm	h cm	Lt	Euro
24	4,5	2	33,26
28	5	3,2	44,22



Casseruola 1 manico / Saucepan cod. R60006..

Ø cm	h cm	Lt	Euro
12	5	0,5	19,18
16	7,5	1,3	24,02



Bollilatte / *Milkpot*
cod. R6006012

Ø cm	h cm	Lt	Euro
12	9	0,9	24,20



Padella / *Frying pan*
cod. R60025..

Ø cm	h cm	Lt	Euro
24	4,5	2	34,70
28	5	3,2	47,88



Cestello vapore / *Steaming basket*
cod. R5009822

Ø cm	h cm	Euro
22	10,5	23,02



Coperchio / *Lid*
cod. R50030..

Ø cm	Master	cm Master	kg Master	Euro
16	12	26x23x33,5	1,8	8,60
18	12	26x23x36	2,11	8,86
20	12	31x20x46	2,41	9,36
22	12	31x20x46	2,94	9,90
24	12	31,5x33,5x45	3,72	10,50
26	12	31x34x45,5	4,24	11,86
28	12	31x34x45,5	5,22	14,26



COMFORT R650

18/0

Con manico in bachelite e fondo termodiffusore.
With bakelite handle and thermal diffusion bottom.

Made in Italy 

NICKEL
FREE



INDUZIONE
INDUCTION



GAS
GAS



CERAMICO
CERAMIC



ALOGENO
HALOGEN



ELETTRICO
ELECTRIC

Pentola / Pot cod. R65003..

Ø cm	h cm	Lt	Euro
16	12	2,1	33,60
18*	13	2,8	37,02
20	14,5	3,8	40,54
22	14,7	5	45,16
24	17,1	6,5	46,94
28*	18	10,5	65,78

* In esaurimento / Discontinued



Casseruola / Casserole cod. R65005..

Ø cm	h cm	Lt	Euro
16	7,5	1,3	30,88
18	8	1,8	34,14
20	9,4	2,4	38,00
22	10,5	3,5	41,62
24	11,4	4,8	44,04
26	13	5,4	51,06
28	14	8	60,98



Tegame / Roasting pan cod. R65023..

Ø cm	h cm	Lt	Euro
24	4,5	2	40,46
28	5	3,2	54,64



Casseruola 1 manico / Saucepan cod. R65006..

Ø cm	h cm	Lt	Euro
12	5	0,5	24,58
16	7,5	1,3	29,76



Bollilatte / *Milkpot*
cod. R6506012

Ø cm	h cm	Lt	Euro
12	9	0,9	27,10



Padella / *Frying pan*
cod. R65025..

Ø cm	h cm	Lt	Euro
24	4,5	2	41,80
28	5	3,2	58,06



Cestello vapore / *Steaming basket*
cod. R6509822

Ø cm	h cm	Euro
22	10,5	34,00



Coperchio / *Lid*
cod. R65031..

Ø cm	Euro
16	11,80
18	12,14
20	12,64
22	14,02
24	14,38
26	15,54
28	18,42



FIRST R800

18/10

Fondo 3 strati.
3 layers bottom.

Articoli venduti in scatola litografata.
Articles are packed in lithographed box.

In esaurimento / Discontinued



INDUZIONE
INDUCTION



GAS
GAS



CERAMICO
CERAMIC



ALOGENO
HALOGEN



ELETTRICO
ELECTRIC

Pentola bassa con coperchio / *Low pot with lid*
cod. R800V3..

Ø cm	Lt	Euro
20	3,1	46,24
24	6,3	56,92
28	11	77,10



Casseruola con coperchio / *Casserole with lid*
cod. R800V1..

Ø cm	Lt	Euro
20	2,5	42,58
24	4,5	54,48



Casseruola 1 manico / *Saucepan*
cod. R8000616

Ø cm	Lt	Euro
16	1,5	28,96



Bollilatte / *Milk pot*
cod. R8006014

Ø cm	Lt	Euro
14	1,5	44,20



FIRST R800

18/0

4 Sistemi di Sicurezza.
4 Safety Systems.

INDUZIONE / INDUCTION



INDUZIONE
INDUCTION



GAS
GAS



CERAMICO
CERAMIC



ALOGENO
HALOGEN



ELETTRICO
ELECTRIC

Pentola a pressione tradizionale
Traditional pressure cooker

cod.	Lt	Ø cm	Euro
R8005103	3,5	20	49,16
R8005105	5	20	51,12
R8005107	7	20	54,90
R8005109	9	22	64,36



Set pentole a pressione Lt 5+7
Pressure cooker set Lt 5+7

cod. R8005D57

Ø cm	Lt	Euro
20	5+7	106,04

Pentola Ø cm 20 5 lt,
Pentola Ø cm 20 7 lt,
Coperchio in acciaio
inox 18/0 per pentola
a pressione Ø cm 20,
Coperchio in vetro
Ø cm 20.

*18/0 stainless steel pot Ø
20 cm 5L capacity, 18/0
stainless steel pot Ø 20 cm
7L capacity, 18/0 pressure
cooker Ø 20 cm lid, Ø 20
cm glass lid.*



RICAMBI / SPARE PARTS

cod. R800500 coperchio completo / lid for pressure cooker



TENDER ALU EASY

Alluminio con rivestimento antiaderente GREBLON COMPOUND professionale a 3 strati, senza PFOA.

Aluminum with GREBLON COMPOUND professional non-stick coating (3 layers), PFOA free.

Manici in tubolare d'acciaio atermico e applicati con rivetti.

Riveted tubular stainless steel handles.



GAS
GAS



CERAMICO
CERAMIC



ALOGENO
HALOGEN



ELETTRICO
ELECTRIC

In esaurimento / Discontinued

Padella bassa con antiaderente / *Non-stick low frying pan*

cod. 350925..

Ø cm	h cm	Lt	Euro
20	4,0	1,0	20,94
24	4,5	1,6	27,88
28	5,2	2,6	34,52
32	6,0	4,0	41,46
36	6,7	5,7	48,28
40	7,5	7,9	57,32
45	8,4	11,2	78,84



Padella alta con antiaderente / *Non-stick deep frying pan*

cod. 3509C5..

Ø cm	h cm	Lt	Euro
20	4,7	1,2	21,18
24	5,4	2,0	28,98
28	6,3	3,3	36,32
32	7,2	5,0	42,74
36	8,1	7,1	51,30



Padella bassa / *Low frying pan*

cod. 350025..

Ø cm	h cm	Lt	Euro
20	4,0	1,0	12,00
24	4,5	1,6	16,96
28	5,2	2,6	21,48
32	6,0	4,0	26,86
36	6,7	5,7	31,92
40	7,5	7,9	38,38
45	8,4	11,2	53,36



Padella alta / *Deep frying pan*

cod. 3500C5..

Ø cm	h cm	Lt	Euro
20	4,7	1,2	12,86
24	5,4	2,0	18,38
28	6,3	3,3	23,28
32	7,2	5,0	27,60
36	8,1	7,1	35,30





POP 3790

Alluminio stampato in 2,5 mm con rivestimento antiaderente XYLAN 2 strati.
2,5 mm pressed aluminum with XYLAN 2 layers non-stick coating.

Fondo HOLE INDUCTION.
Bottom: HOLE INDUCTION.

Manici in bakelite atermica.
Handle with "stay-cool" bakelite material.

NICKEL
FREE



INDUZIONE
INDUCTION



GAS
GAS



CERAMICO
CERAMIC



ALOGENO
HALOGEN



ELETTRICO
ELECTRIC

Casseruola alta con coperchio / *Deep casserole with lid*
cod. 3790V1..

Ø cm	h cm	Lt	Euro
20	7,7	2,4	35,16
24	10,5	4,8	46,98



Casseruola 1 manico / *Saucepan*
cod. 37900616

Ø cm	h cm	Lt	Euro
16	6,7	1,3	19,94



Wok con coperchio / *Wok with lid*
cod. 37909528

Ø cm	h cm	Lt	Euro
28	7,67	4,1	46,22



Crepiera / *Crepe frying pan*
cod. 37904525

Ø cm	h cm	Lt	Euro
25	1,61	0,7	21,56



Bistecchiera / *Grill pan*
cod. 37905326

Ø cm	h cm	Lt	Euro
26	3,98	2,3	32,14



Set 2 padelle
Set 2 frying pans

cod.	Ø cm	Euro
37902503	20+24	41,10
37902504	24+28	50,66



Set 3 padelle
Set 3 frying pans

cod.	Ø cm	Euro
37902500	20+24+28	67,42



Padella / Frying pan
cod. 379025..

Ø cm	Lt	Euro
20	1,1	18,92
22	1,3	20,64
24	1,8	23,70
26	1,9	25,40
28	2,8	29,16
30	3,0	32,18



padella con manico e maniglia / frying pan
with counter handle
cod. 37902532

Ø cm	h cm	Lt	Euro
32	5,39	3,9	36,50



POP EXTRA 3790

Alluminio stampato in 2 mm con rivestimento antiaderente 2 strati.
2 mm pressed aluminum with 2 layers non-stick coating.

Manico in bakelite atermica.
Handle with "stay-cool" bakelite material.

NICKEL
FREE



GAS
GAS



CERAMICO
CERAMIC



ALOGENO
HALOGEN



ELETTRICO
ELECTRIC

Padella pancake e uova / Egg & pancake frying pan
cod. 37902G25

Ø cm	Euro
25	18,76



COOK-IT

3190

Alluminio stampato con rivestimento antiaderente 5 strati.
Pressed aluminum with 5 layers non-stick coating.

Made in Italy 

Manico in materiale termoisolante antiscottatura.
Handle with "stay-cool" material.

NICKEL
FREE



GAS
GAS



CERAMICO
CERAMIC



ALOGENO
HALOGEN



ELETTRICO
ELECTRIC

Padella / *Frying pan*
cod. 319025..

Ø cm	Euro
20	9,54
24	11,64
28	14,08



Padellino uovo / *Egg frying pan*
cod. 31902514

Ø cm	Euro
14	6,88



Crepiera / *Crepe frying pan*
cod. 31904525

Ø cm	Euro
25	10,28



Gira frittata / *Omelette pan*
cod. 31902D26

Ø cm	Euro
26	22,98



X-BLACK 4180

Alluminio forgiato con rivestimento antiaderente senza PFOA.
Forged aluminum with PFOA-free non-stick coating.

Bordo rinforzato 3,5 mm.
3.5 mm reinforced rim.

Manici in bakelite atermica.
Handle with "stay-cool" bakelite material.

NICKEL
FREE



INDUZIONE
INDUCTION



GAS
GAS



CERAMICO
CERAMIC



ALOGENO
HALOGEN



ELETTRICO
ELECTRIC

Casseruola fonda con coperchio / *Deep casserole with lid*
cod. 4180V1..

Ø cm	Lt	Euro
20	2,3	28,34
24	4,2	34,12
28	6,6	47,90



Casseruola fonda / *Deep casserole*
cod. 418005..

Ø cm	Lt	Euro
20	2,3	21,04
24	4,2	25,54
28	6,6	36,54



Casseruola 1 manico / *Saucepan*
cod. 41800616

Ø cm	Lt	Euro
16	1,2	16,08



Wok con coperchio / *Wok with lid*
cod. 41809528

Ø cm	Lt	Euro
28	3,5	36,48



Wok / *Wok*
cod. 41809S28

Ø cm	Lt	Euro
28	3,5	26,36



Crepiera / Crepe frying pan
cod. 41804525

Ø cm	Lt	Euro
25	0,5	24,14



Bistecchiera / Grill pan
cod. 41805328

Ø cm	Lt	Euro
26	2,2	29,06



Set 2 padelle / Set 2 frying pans
cod. 41802504

Ø cm	Euro
24+28	42,30



Padella / Frying pan
cod. 418025..

Ø cm	Lt	Euro
20	1,0	15,30
24	1,6	17,84
26	2,0	19,54
28	2,4	21,90
30	3,3	24,36



Coperchio / Lid
cod. 40403A..

Ø cm	Euro
20	8,02
22	8,06
24	8,86
26	9,52
28	10,56



SMART 4240

Alluminio stampato con rivestimento antiaderente senza PFOA.
Stamped aluminum with PFOA-free non-stick coating.

Manico in bakelite atermica.
Handle with "stay-cool" bakelite material.

NICKEL
FREE



INDUZIONE
INDUCTION



GAS
GAS



CERAMICO
CERAMIC



ALOGENO
HALOGEN



ELETTRICO
ELECTRIC

Set 2 padelle / *frying pans set*
cod. 42402501

Ø cm	Euro
24+28	28,00



PORTOFINO

305_

Alluminio con rivestimento antiaderente 5 strati, senza PFOA.
Aluminum with 5-layer non-stick coating PFOA free.

Made in Italy 

Manico in materiale antiscottatura.
Handle with thermosetting material.

NICKEL
FREE



GAS
GAS



CERAMICO
CERAMIC





ALOGENO
HALOGEN



ELETRICO
ELECTRIC

Padella / Frying pan

cod.	Ø cm	colour	Euro
305B2520	20		11,64
305B2524	24	ROSA	14,44
305B2528	28	TRAMONTO	17,38
305C2520	20		11,64
305C2524	24	BLU MARE	14,44
305C2528	28	BLU MARE	17,38
305A2520	20		11,64
305A2524	24	VERDE	14,44
305A2528	28	VERDE BASILICO	17,38



GASTRONORM

GN-P

RBA_

Gastronorm in acciaio inox 18/10.
18/10 stainless steel gastronorm.

Bacinella 1/1 Basin 1/1

cod.	OUT mm	h mm	Lt	Master	cm Master	kg Master	Euro
RBA11020	530x325	20	tray	5	35x55x10	5,25	27,90
RBA11040		40	5,4		35x55x10	5,15	30,04
RBA11065		65	8,7		35x55x10	7,58	34,32
RBA11100		100	13,0		35x55x20	7,99	42,90
RBA11150		150	20,0		35x55x30	10,40	55,78
RBA11200		200	26,0		35x55x34	11,42	75,10

Bacinella 1/2 Basin 1/2

cod.	OUT mm	h mm	Lt	Master	cm Master	kg Master	Euro
RBA12020	325x265	20	tray	10	34x38x10	4,60	17,16
RBA12040		40	2,4	10	34x38x10	5,13	19,32
RBA12065		65	3,8	10	35x55x10	5,97	21,46
RBA12100		100	5,9	10	35x55x20	9,37	23,62
RBA12150		150	8,7	5	34x38x20	6,07	36,48
RBA12200		200	11,0	5	35x55x25	5,88	47,20

Bacinella 1/3 Basin 1/3

cod.	OUT mm	h mm	Lt	Master	cm Master	kg Master	Euro
RBA13065	325x176	65	2,5	10	35x55x10	5,76	19,32
RBA13100		100	3,8		34x38x20	6,49	23,62
RBA13150		150	5,5		34x38x20	6,49	34,32
RBA13200		200	7,0		35x55x20	9,15	47,20

Bacinella 1/4 Basin 1/4

cod.	OUT mm	h mm	Lt	Master	cm Master	kg Master	Euro
RBA14020	265x162	20	tray	10	17x27x10	2,62	15,04
RBA14040		40	1,2	10	17x27x10	3,72	17,16
RBA14065		65	1,7	10	17x27x20	3,78	21,46
RBA14100		100	2,7	20	35x55x20	10,20	25,74
RBA14150		150	3,8	10	35x55x20	5,17	30,04
RBA14200		200	4,8	10	35x55x30	9,34	45,06

Bacinella 1/6
Basin 1/6

cod.	OUT mm	h mm	Lt	Master	cm Master	kg Master	Euro
RBA16065	176x162	65	1,0	20	17x27x20	5,00	15,04
RBA16100		100	1,6		35x55x20	6,61	19,32
RBA16150		150	2,2		34x38x20	8,34	32,20
RBA16200		200	2,8		35x55x20	10,66	38,62

Bacinella 1/9
Basin 1/9

cod.	OUT mm	h mm	Lt	Master	cm Master	kg Master	Euro
RBA19065	176x108	65	0,6	30	34x38x20	7,47	15,03
RBA19100		100	0,9		34x38x20	8,51	17,16

Bacinella 2/1
Basin 2/1

cod.	OUT mm	h mm	Lt	Master	cm Master	kg Master	Euro
RBA21020	650x530	20	tray	5	56x67x10	11,88	51,48
RBA21040		40	12,0		56x67x10	11,75	60,06
RBA21065		65	19,0		56x67x10	13,76	66,52
RBA21100		100	29,0		56x67x20	15,25	81,52
RBA21150		150	43,0		56x67x27	18,34	118,00
RBA21200		200	57,0		56x67x27	21,13	139,46

Bacinella 2/3
Basin 2/3

cod.	OUT mm	h mm	Lt	Master	cm Master	kg Master	Euro
RBA23020	354x325	20	tray	10	34x38x10	5,86	19,32
RBA23040		40	3,4		34x38x10	8,40	25,74
RBA23065		65	5,5		34x38x20	10,37	27,90
RBA23100		100	8,4		34x38x30	12,89	36,48
RBA23150		150	12,0		34x38x35	14,00	51,48
RBA23200		200	16,0		34x38x35	14,04	60,06

Coperchio bacinella
Basin lid

cod.	Mod.	OUT mm	h mm	Lt	Master	cm Master	kg Master	Euro
RCO11000	1/1	530x325	-	-	10	35x55x20	10,86	30,04
RCO12000	1/2	325x265	-	-	10	34x28x20	5,38	19,32
RCO13000	1/3	325x176	-	-	10	34x28x10	3,52	17,16
RCO14000	1/4	265x162	-	-	10	17x27x20	2,60	12,88
RCO16000	1/6	176x162	-	-	20	34x28x10	3,64	10,74
RCO19000	1/9	176x108	-	-	20	17x27x20	2,51	10,74
RCO23000	2/3	354x325	-	-	10	34x38x20	7,98	23,62

MULTIPLI: LE COMBINAZIONI

Multiples: the combinations

2/1



1/1



2/3

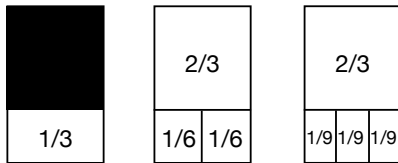

1/2

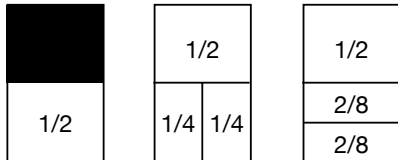

2/4

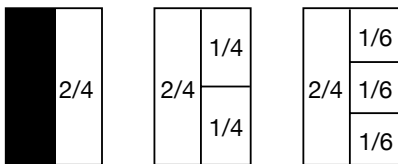

1/3

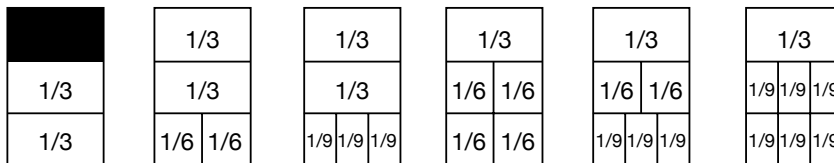

1/4

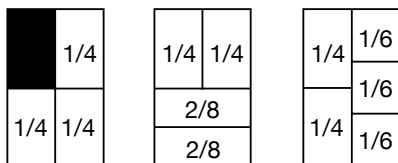

2/8

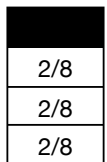

1/6

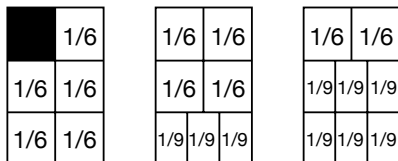

1/9

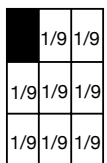

UTENSILI DA CUCINA
KITCHEN TOOLS

GADGET FAST

7820

Acciaio inox con manico in polipropilene ergonomico.
Stainless steel with ergonomic handle in polipropilene.

Design bicolore e packaging dedicato per ogni articolo.
Two-tones design and dedicated packaging for each item.

Spremi aglio / *Garlic press*
cod. 78200001
Euro 5,98



Apribottiglia / *Bottle opener*
cod. 78200002
Euro 2,68



Scavino melone / *Melon baller*
cod. 78200003
Euro 2,68



Pelapatate / *Peeler*
cod. 78200004
Euro 2,68



Pelapatate multiuso
con lama liscia / *Peeler plain*
cod. 78200005
Euro 2,68



Pelapatate multiuso con lama
seghettata / *Peeler serrated*
78200006
Euro 2,68



Dosatore gelato / *Ice-cream scoop*
cod. 78200007
Euro 3,24



Coltello burro / *Butter knife*
cod. 78200008
Euro 2,68



Riga limoni / *Lemon zester*
cod. 78200009
Euro 2,68



Rotella taglia pizza / *Pizza cutter*
Ø cm 10
cod. 78200010
Euro 4,34



Rotella taglia pizza / *Pizza cutter*

Ø cm 6,5

cod. 78200011

Euro 3,24



Rotella seghettata / *Pastry wheel serrated*

Ø cm 5,5

cod. 78200012

Euro 2,68



Rotella doppia / *Pastry wheel double*

cod. 78200013

Euro 3,78



Scava zucchine / *Zucchini corer*

cod. 78200014

Euro 2,68



Affilacoltelli / *Knife sharpener*

cod. 78200015

Euro 4,34



Leva torsolo / *Apple corer*

cod. 78200016

Euro 2,68



Tagliaverdure / *Vegetable cutter*

cod. 78200017

Euro 2,68



Grattugia lama fina / *Fine grater*

cod. 78200018

Euro 2,68



Grattugia lama grossa / *Coarse grater*

cod. 78200019

Euro 2,68



Pala taglia formaggi / *Cheese slicer*

cod. 78200020

Euro 3,24



Pala torta / *Cake server*

cod. 78200021

Euro 3,24



Pala pizza seghettata / *Pizza-pie server*

cod. 78200022

Euro 3,24





GADGET FPR

782F

Acciaio inox con manico in polipropilene ergonomico.
Design bicolore e packaging dedicato per ogni articolo.

Stainless steel with ergonomic handle in polipropilene.
Two-tones design and dedicated packaging for each item.

Apribottiglia / *Bottle opener*

cod. 782F0002

Euro 2,68



Scavino melone / *Melon baller*

cod. 782F0003

Euro 2,68



Pelapatate / *Peeler*

cod. 782F0004

Euro 2,68



Pelapatate ad arco / *Y-peeler*

782F0025

Euro 2,68



Dosatore gelato / *Ice-cream scoop*

cod. 782F0007

Euro 3,24



Spatola / *Turner*

cod. 782F0022

Euro 3,24



Pennello in silicone / *Silicone brush*

cod. 782F0023

Euro 3,24



Rotella taglia pizza / *Pizza cutter*

Ø cm 6,6

cod. 782F0011

Euro 3,24



Leva torsolo / *Apple corer*
cod. 782F0016
Euro 2,68



Grattugia / *Grater*
cod. 782F0024
Euro 4,90



Apriscatole / *Can opener*
cod. 782F0026
Euro 4,90



Mestolo salsa / *Sauce ladle*
cod. 782F0029
Euro 3,90



Pala fritto / *Spatula*
cod. 782F0030
Euro 3,48



Cucchiaione / *Serving spoon*
cod. 782F0031
Euro 3,48



Servispaghetti / *Spaghetti server*
cod. 782F0032
Euro 3,48



Forchettone / *Carving fork*
cod. 782F0033
Euro 3,48



Mestolo / *Ladle*
cod. 782F0028
Euro 3,90



Frusta / *Whisk*
cod. 782F0034
Euro 2,98



Schiumarola / *Skimmer*
cod. 782F0027
Euro 3,90



Colino / *Strainer*
cod. 782F0035
Euro 4,90



Schiaccianoci / *Nutcracker*
cod. 782F0036
Euro 7,48



Cavatappi due leve / *Corkscrew winged*
cod. 587F4100
Euro 11,28



Cavatappi professionale / *Professional corkscrew*
cod. 587F4300
Euro 3,48



Batticarne / *Meat mallet*
cod. 782F0037
Euro 7,90



Apribarattoli / *Jar opener*
cod. 782F0038
Euro 6,90



Frullino / *Manual whisk*
cod. 782F0039
Euro 6,48



Frusta in silicone / *Silicone whisk*
cod. 782F0040
Euro 3,90



Frangi fiamma / *Heat diffuser*
cod. 782F0041
Euro 3,90



Para spruzzi / *Splash guard*
cod. 782F0043
Euro 6,48



SMART

5217

Nylon PA66 - Max 210°C

Consigliati per padelle antiaderenti.
Recommended for non-stick frying pans.

Cucchiaio / *Serving spoon*

cod. 52170000

Euro 3,80



Cucchiaio forato / *Perforated spoon*

cod. 52170100

Euro 3,80



Mestolo / *Ladle*

cod. 52172000

Euro 3,80



Schiumarola / *Skimmer*

cod. 52174000

Euro 3,80



Servispaghetti / *Spaghetti server*

cod. 52177000

Euro 3,80



Spatola / *Spatula*

cod. 52176000

Euro 3,80



Spatola forata / *Perforated spatula*

cod. 52173000

Euro 3,80



Frusta / *Whisk*

cod. 52171800

Euro 3,80



Pinza / *Chef tong*

cod. 52179100

Euro 3,80





PINTI INOX S.p.A.
Via Antonini, 87
25068 Sarezzo (BS) Italia
Tel. +39 030 89351
Fax +39 030 8935250
+39 030 8901163
www.pintinox.com
pintinox@pinti.it

PINTI INOX GMBH
DEUTSCHLAND
Römerstraße 91
73066 Uhingen
Tel +49 07161 93343-0
Fax +49 07161 352789
www.pinti.de
info@pinti.de