

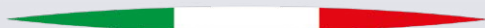

Catalogo | Catalogue
2024

Guardini®



MADE in ITALY





Guardini®

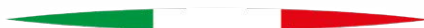

MADE in ITALY

Esperienza, Passione e Creatività Made in Italy

Da oltre **75 anni** Guardini è leader nella produzione di stampi da forno; un brand di Volpiano (To) conosciuto in tutto il mondo, che ha scritto la propria storia con passione, talento artigianale trasformato in capacità produttiva, ingegno creativo, continua ricerca e sperimentazione.

Tra passato e futuro

La storia di Guardini affonda le radici nel passato: sono trascorsi oltre 75 anni da quando a Torino viene fondata la bottega artigianale di famiglia specializzata in articoli casalinghi. Negli **anni '70** la piccola bottega si trasforma in azienda e con il tempo cresce e si specializza. Negli **anni '80** inizia la produzione dei primi stampi in acciaio con rivestimento antiaderente, oggi core business dell'azienda. Nel **1990** il brand entra in GDO e si espande fino a diventare, nel **2010**, uno dei Top European Players nella produzione di stampi da forno.

Oggi la Guardini S.p.A. è leader di mercato nella produzione di stampi da forno ed esporta l'eccellenza **Made in Italy** in tutto il mondo.

Esperienza e tradizione sono i cardini intorno ai quali nascono e maturano progetti, metodi di produzione e prodotti che guardano al futuro, moderni ed innovativi, sempre sensibili verso i nuovi trend di mercato e le esigenze di un consumatore attento ed evoluto.

Guardini. Oltre 75 anni di storie e sapori italiani.

Experience, Passion and Creativity Made in Italy

For over **75 years** Guardini has been a leader in the production of bakeware products; we are based in Volpiano (To) and our brand is world known; our history tells a story of passion, craftsmanship which translates into production ability, creative work, continuous research and experimentation.

Between past and future

Guardini's history finds its roots in the past: it has been over 75 years since the family houseware workshop was established. In the **1970s** the small workshop turned into a company and, over time, it grew and became specialized. In the **1980s**, it started the production of the first steel moulds with non-stick coating, which today are the core products of the company. In **1990** the brand entered into large scale retail channels and it expanded to become one of the Top European Players in the production of bakeware in **2010**.

Today, Guardini S.p.A. is a leading company in the production of bakeware and it exports **Made in Italy** excellence around the world.

Experience and tradition are the two key elements around which projects, production methods and future products are created and developed; our products are modern and innovative, they capture new market trends and meet the needs of demanding and attentive consumers.

Guardini. Over 75 years of italian stories and flavours.



2012-2018



2019-OGGI



I numeri del successo Our success translated in numbers

26 linee di prodotto a marchio Gardini / product lines under the Gardini brand



17.000 mq di area industriale / square meter plant facility



50 collezioni di Private Labels / Private Labels collections



60 forme da forno progettate e realizzate in sede / moulds designed and manufactured in-house



50.000 pezzi prodotti in sede ogni giorno / units produced in our plant every day



90 dipendenti / employees



Questi sono i numeri vincenti di un'azienda che ha saputo rinnovare e sviluppare le proprie risorse, moltiplicando le esperienze per mettere a punto una **crescita costante**. Un percorso virtuoso di "evoluzione industriale" che oggi fa di Gardini una realtà solida, riconosciuta e tecnologicamente avanzata. Sono **numerose le insegne della GDO nazionale ed internazionale** che hanno affidato a Gardini la private label e gli stampi da forno prodotti a Volpiano, i quali vengono spediti in **oltre 50 paesi in tutto il mondo**.

Il valore del Made in Italy

La produzione Gardini è per il 99% Made in Italy. Anche se il mercato di riferimento è quello italiano, l'eccellenza dei prodotti italiani Gardini ha conquistato l'estero. L'esportazione (circa il 75% del fatturato) coinvolge oggi l'Europa, i Paesi Arabi, l'America e il Nord Africa.

*These outstanding numbers show the success of a company which has been able to innovate and develop its resources, by multiplying its experience to ensure its **constant growth**. A virtuous path of "industrial evolution" that today makes Gardini a very solid, recognized and technologically advanced business. **Several national and international large scale** retail channels gave Gardini their private label and the bakeware produced in Volpiano are now shipped to **over 50 countries around the world**.*

The value of Made in Italy products

Gardini production is 99% Made in Italy. Even if its main market of reference is the Italian market, the excellence and high quality of Gardini's products has swept the world. Exports (which account for about 75% of the business turnover) include Europe, Arab countries, America and North Africa.



I prodotti: passione e qualità

Guardini è soprattutto fantasia, talento e sensibilità, che permettono di cogliere le esigenze in evoluzione, per trasformarle in prodotti e soluzioni ideali.

Sempre attenta ai gusti di chi acquista e alle necessità di chi vende, Guardini sa interpretare con creatività i desideri e i bisogni di chi ama cucinare, senza dimenticare di offrire alla distribuzione le soluzioni commerciali più efficaci.

La qualità dei materiali, la competitività dei prezzi, l'enorme varietà di forme, colori e di funzioni d'uso, fanno dei numerosi prodotti Guardini gli alleati indispensabili per chiunque voglia vivere il mondo della cucina con allegria e spirito creativo.

Il successo passa anche attraverso la continua ricerca di materiali eccellenti che garantiscono prestazioni eccezionali: **facilità di cottura e di pulizia, resistenza all'usura e sfornabilità impeccabile.**

Acciaio Hi-Top, rivestimenti antiaderenti innovativi di ultima generazione, silicone alimentare di qualità, ma anche proposte in carta da forno e ceramica. Una gamma completa di stampi ed accessori, la migliore risposta alle esigenze culinarie di chi vive con passione la cucina.

Our products: passion and quality

Guardini is especially synonymous of creativity, talent and sensitivity, which capture the changing needs and transform them into ideal products and solutions.

Always attentive to the consumers' taste and retailers' needs, Guardini knows how to creatively interpret the wishes and needs of those who love cooking, without neglecting to offer the most effective commercial solutions to its distributors.

The quality of materials, the competitiveness of prices, the wide range of shapes, colors and usages, make the numerous Guardini's products the indispensable allies of anyone wishing to live a unique cooking experience with joy and creativity.

*Success also goes through continuous research for excellent materials ensuring exceptional performances: **good for cooking, easy to clean, wear-resistant and impeccable shape of foods after removal from the moulds.***

Hi-Top steel, innovative, last-generation non-stick coating, high quality silicone for food stuffs, as well as parchment paper and ceramic solutions. A complete range of moulds and accessories and the best solution to satisfy the cooking needs of cooking lovers.



La filosofia produttiva

Guardini non si ferma mai: investe in ricerca tecnologica per offrire sempre prodotti superiori e di alta qualità. **Elevato standard di prodotto ed efficienza nel servizio al cliente per un programma di Qualità Totale:** questa è la mission di Guardini.

Gli ingenti e costanti investimenti in tecnologia e ricerca e sviluppo sono uno dei segreti del successo di Guardini, che oggi vanta uno stabilimento produttivo completamente automatizzato, a garanzia di elevata produttività e competitività dei prezzi.

La flessibilità e la capacità di modulare la produzione sulle richieste del mercato hanno permesso alla Guardini di aprirsi al grande business delle private labels, ad oggi al centro dei principali progetti del trade moderno.

Questo per Guardini significa garantire qualità, volumi, versatilità nelle personalizzazioni, rintracciabilità del prodotto, a prezzi competitivi, il tutto con **una produzione completamente italiana:** una sfida complessa, ma affrontata con successo.

I risultati? Guardini ha ottenuto la Certificazione di Qualità UNI EN ISO 9001:2015 e la Certificazione etica SA 8000:2014. La dimostrazione di un progetto in continua crescita che va oltre i traguardi raggiunti.

La Certificazione di Qualità **UNI EN ISO 9001:2015** rappresenta per GUARDINI l'impegno al miglioramento continuo delle performance aziendali, in termini di prodotto, di processo produttivo e di organizzazione aziendale.

Con la Certificazione **SA 8000:2014** GUARDINI esprime il proprio credo nella Responsabilità Sociale d'impresa, un modo di fare impresa nel rispetto delle persone e dell'ambiente che ci circonda.

Abbiamo inoltre ottenuto lo status di **AEO (Authorized Economic Operator)**, in quanto in possesso degli adeguati standard pratici di competenza o qualifiche professionali.



Our production philosophy

Guardini never stops: it invests in technological research in order to offer top quality products all the time.

High quality products and efficient customer service provide a Total Quality approach: this is Guardini's mission.

The substantial and constant investments in technology and research are one of the secrets of Guardini's success, which today has a fully automated production plant, designed to guarantee high productivity and price competitiveness.

Flexibility and ability to adjust production according to market demands allowed Guardini to open up to the large business of private labels, which today is at the heart of the main modern trade projects.

For Guardini this means ensuring quality, volumes, versatility in customization, traceability of products, at competitive prices, associated to a fully Italian-based production: a difficult

challenge, however tackled with success.

What are the results? Guardini obtained the UNI EN ISO 9001:2015 Quality Certification and the SA 8000:2014 Ethical Certification. This demonstrates that the project keeps on growing well beyond the already achieved objectives.

The UNI EN ISO 9001:2015 Quality Certification represents for GUARDINI its commitment to business performance continuous improvement, in terms of products, production process and business organization.

The SA 8000:2014 Certification demonstrates GUARDINI's belief in Corporate Social Responsibility, a way of doing business that respects people and the environment.

We have also obtained the status of AEO (Authorized Economic Operator), as it possesses the appropriate practical standards of competence or professional qualifications.

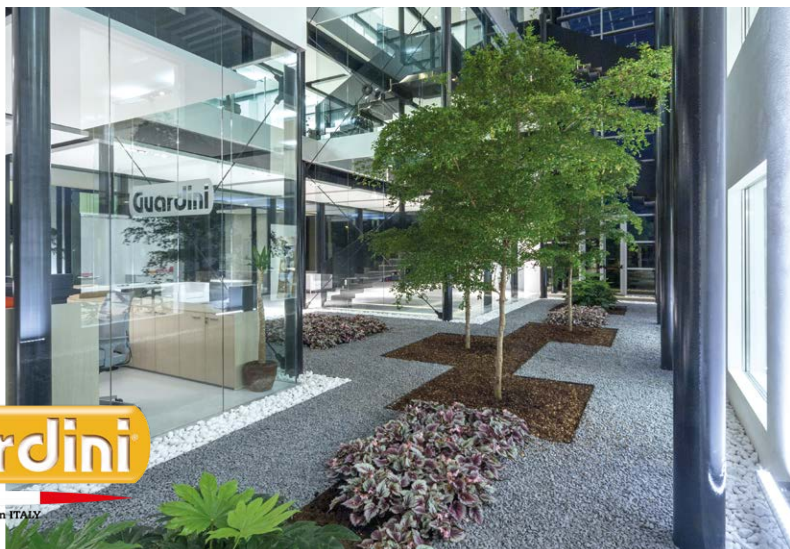

MADE IN ITALY

Bilancio di sostenibilità

La sostenibilità è un principio ispiratore che investe ogni aspetto della nostra azienda. Non è solo una filosofia, ma **un vero e proprio piano di azione**, che ogni giorno si arricchisce di nuove idee e soluzioni, che mirano a rendere sempre più sostenibile la vita dell'azienda e l'impatto della sua attività sul mondo esterno.

Garantire la continuità produttiva, investire nelle filiere introducendo **principi di responsabilità condivisa**, ridurre l'impatto ambientale in termini di emissioni e consumo di risorse, creare **partnership di valore** per lo sviluppo di **prodotti e soluzioni sostenibili**, sono gli impegni che perseguiamo ogni giorno.

Per questo, pur non essendo previsto alcun obbligo normativo, abbiamo scelto di redigere **il nostro primo Bilancio di Sostenibilità**, orgogliosi di poter condividere i risultati ottenuti, che non rappresentano per noi un traguardo, ma le tappe di un **percorso virtuoso di crescita**.

Il Bilancio raccoglie i progetti e le iniziative che impegnano l'azienda sui temi della **responsabilità d'impresa**, della **sostenibilità ambientale e sociale**.

L'obiettivo è quello di rendicontare gli impegni e i risultati raggiunti e di comunicarli in maniera tangibile e trasparente a tutti gli **stakeholder** coinvolti direttamente o indirettamente nell'attività dell'azienda.

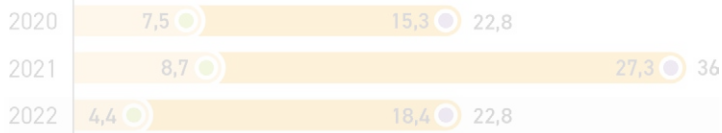

Sustainability Report

*Environmental sustainability is an inspiring principle that invests every aspect of our Company. It is not just an idea, but a **real action plan**, which is enriched every day with new ideas and solutions. A plan that aims to make the life of the Company and the impact of its activity on the outside world more and more sustainable.*

*Guaranteeing continuity of production, investing in supply chains by introducing principles of **shared responsibility**, reducing our environmental impact in terms of emissions and resource consumption, creating **valuable partnerships** for the development of **sustainable products and solutions**: these are our commitments which we pursue every day.*

*This is why, although it is not a regulatory requirement, we have chosen to publish **our first Sustainability Report**, and we are proud to be able to share our results, which are not the end point for us, but rather stages along a **virtuous journey of growth**.*

*The Report collects the projects and initiatives that involve the Company in the themes of **Corporate Responsibility, Environmental and Social Sustainability**.*

*The objective is to report the commitments and results achieved and to communicate them in a tangible and transparent way to all **stakeholders** involved directly or not directly in the Company's activities.*

And this is why we have the pleasure of sharing it with you.



Qui il link al documento sfogliabile all'interno del nostro sito web.



Here you will find the link to the browsable document at the inside of our website.



4 ACTIONS 4 MORE

SUSTAINABLE IMPACT

ACTIONS4MORE 4 Pillars

La sostenibilità è un principio ispiratore che investe ogni aspetto della nostra azienda. Non è solo una filosofia, ma **un vero e proprio piano di azione**, che ogni giorno si arricchisce di nuove idee e soluzioni, che mirano a rendere sempre più sostenibile la vita dell'azienda e l'impatto della sua attività sul mondo esterno.

Actions4more è il nostro programma per i prossimi anni, che parlerà di **Persone, Prodotti, Processi e Passione** e se ne occuperà con azioni concrete, perché vogliamo fare di più.

Actions4More rappresenta questo impegno, presente e futuro. Perché solo contribuendo con **le azioni** si può davvero fare la differenza.

ACTIONS4MORE 4 Pillars

*Environmental sustainability is an inspiring principle that invests every aspect of our company. It is not just an idea, but a **real action plan**, which is enriched every day with new ideas and solutions. A plan that aims to make the life of the company and the impact of its activity on the outside world more and more sustainable.*

Actions4more is our program for the coming years, which will involve **People, Products, Processes and Passion** and it will deal with them with concrete actions, because we want to do more.

Actions4More represents this present and future commitment. Because only with **true actions** we can really make a difference.

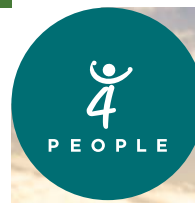

PEOPLE

LA CREAZIONE DEL VALORE PASSA DALLE PERSONE

Ci poniamo come obiettivo quello di coltivare e diffondere una cultura aziendale duratura basata sul **rispetto**, sulla **responsabilità** e sulla **tensione al miglioramento continuo**, che risulta fondamentale per il raggiungimento di obiettivi condivisi, perseguibili solo attraverso il **contributo di ciascuno**. Il vivere quotidianamente questi temi è la testimonianza migliore del nostro impegno, il cui aspetto identitario si rafforza all'interno e al di fuori dell'azienda e si connota di valori "umani". Le risorse stesse, coinvolte, motivate e sensibilizzate rispetto ai valori aziendali, diventano promotrici di **comportamenti etici e responsabili**, che adottano con consapevolezza e interpretano come un vero e proprio stile di vita.

PEOPLE

THE CREATION OF VALUE COMES FROM PEOPLE

We aim to cultivate and roll out an enduring corporate culture based on **respect, responsibility** and the drive for **continuous improvement**, which is fundamental for achieving the shared goals that can only be attained if every **individual contributes**. We live these issues every day, a testament to our commitment, the identity of which is growing inside and outside the company, imbued with 'human' values. The people feel involved, motivated and more aware of the corporate values, becoming promoters of **ethical and responsible behaviour**, which they consciously adopt and interpret so that they become a true way of life.

PRODUCT

LA QUALITÀ DIVENTA SOSTENIBILE

Il **marchio Guardini**, da sempre espressione di qualità, know-how e made in Italy, diventa oggi **sinonimo di sostenibilità**, una scelta necessaria e condivisa lungo tutta la filiera produttiva. Grazie al livello di **expertise** maturata nel corso degli anni, siamo in grado di realizzare stampi da forno con **spessore ottimizzato**, garantendo ottime performance, ottimizzando la quantità di materiale impiegato e riducendo i tempi di cottura, con il conseguente **risparmio energetico** che ne deriva. Tale argomento costituisce il caposaldo della nostra comunicazione attraverso il concetto di "**leggerezza**", uno stato emotivo con cui vivere i momenti di convivialità in cucina, ma anche una caratteristica funzionale degli stampi, progettati per minimizzare l'impatto in fase di utilizzo secondo i principi di sostenibilità.

PRODUCT

THE QUALITY GOES GREEN

The **Guardini brand**, which has always been an expression of quality, know-how and Made in Italy, is now **synonymous with sustainability**, a necessary and shared choice along the entire production chain. Thanks to the level of **expertise** we have gained over the years, we are able to produce baking moulds with the **optimised thickness**, guaranteeing outstanding performance, optimising the amount of material used and reducing cooking times, with the ensuing **energy savings**. This topic constitutes the cornerstone of our communications through the concept of "**lightness**", a feeling of joyful time shared together in the kitchen, as well as the functional characteristic of the moulds designed to minimise its impact during use in line with the principles of sustainability.

PROCESS

MINORE IMPATTO AMBIENTALE, MAGGIORI RISULTATI

In contrapposizione agli indubbi rischi che porta con sé, ogni contesto di cambiamento può rappresentare un'opportunità di **positivo rinnovamento**; l'importante è individuare le giuste strategie per poterlo governare. Aumentando il livello di consapevolezza in merito all'impatto diretto ed indiretto delle nostre attività, abbiamo potuto identificare i processi critici e le **aree di miglioramento** lungo tutta la catena del valore, definire le linee guida per integrare i sistemi di gestione aziendale esistenti e sviluppare **progetti di economia circolare** e di efficienza energetica volti a ridurre le emissioni climalteranti.

PROCESS

LOWER ENVIRONMENTAL IMPACT, GREATER RESULTS

In contrast to the undoubted risks that change brings, every change situation can also represent an opportunity for **positive renewal**; the important thing is to identify the right strategies to be able to lead it. By increasing the level of awareness of the direct and indirect impact of our activities, we have been able to identify critical processes and **areas for improvement** along the entire value chain, defining guidelines for integrating existing business management systems and **developing a circular economy** and energy efficiency projects aimed at reducing climate-changing emissions.

PASSION

LA PASSIONE È LA NOSTRA FORZA MOTRICE

Poniamo al centro della nostra strategia aziendale la **sostenibilità ambientale** e la **responsabilità sociale**, che rappresentano oggi la "**giusta causa**" capace di creare valore attraverso il senso di appartenenza e la **passione delle persone**. La leadership non appartiene ad un singolo, ma è distribuita nell'organizzazione, che ispira il proprio agire quotidiano e risponde alle sfide che si presentano ogni giorno identificando il bene dell'azienda con il suo **sviluppo duraturo**.

PASSION

IS OUR DRIVING FORCE

We place **environmental sustainability** and **social responsibility** at the centre of our corporate strategy, a "**just cause**" which today can create value through **people's sense** of belonging and **passion**. Leadership is not embodied by one individual, it is distributed throughout the organisation, inspiring daily action and responding to everyday challenges by identifying the good of the company with its **lasting development**.

Guardini®





INDICE INDEX

10

STAMPI IN ACCIAIO STEEL MOULDS

- 16 XBake
- 22 B-Nat
- 28 Gold Elegance
- 34 Silver Elegance
- 40 Arianna
- 46 Gardenia
- 56 Bon Ton
- 62 Chocoforme
- 68 Happy Hour
- 74 Rossana
- 82 Bake Away
- 86 Pizza&Mania
- 90 Tampografia / Pad printing

92

STAMPI IN ALLUMINIO ANODIZZATO ANODIZED ALUMINIUM MOULDS

- 94 Professional **NEW**

100

STAMPI IN ALLUMINIO PRESSOFUSO CAST ALUMINIUM MOULDS

- 102 Sweet Magic

108

STAMPI IN BANDA STAGNATA TINPLATE MOULDS

- 110 Selenia

114

STAMPI IN VETRO BOROSILICATO BOROSILICATE GLASS MOULDS

- 116 Vetro borosilicato / Borosilicate Glass **NEW**

120

COLLEZIONI CARTA & PLASTICA PAPER & PLASTIC COLLECTIONS

- 122 Easy Bake Bio **NEW**
- 126 Easy Bake

134

STAMPI IN SILICONE SILICONE MOULDS

- 136 Juliette

142

PIROFILE IN CERAMICA CERAMIC BAKEWARE

- 144 Ceramica / Ceramic

148

ACCESSORI GADGETS

- 150 Stampi per friggitrice ad aria / Moulds for air fryer **NEW**
- 154 Ricorrenze / Celebrations
- 157 Tagliabiscotti / Cookie cutters **NEW**
- 158 Coppapasta / Food rings
- 160 Anelli regolabili / Extendable cake rings

162

IDEE REGALO GIFT IDEAS

166

ESPOSITORI DISPLAYS

170

I NOSTRI VIDEO OUR VIDEOS





Guardini®

10-91

ACCIAIO STEEL

STAMPI IN ACCIAIO STEEL MOULDS

- 16 XBake
- 22 B-Nat
- 28 Gold Elegance
- 34 Silver Elegance
- 40 Arianna
- 46 Gardenia
- 56 Bon Ton
- 62 Chocoforme
- 68 Happy Hour
- 74 Rossana
- 82 Bake Away
- 86 Pizza&Mania
- 90 Tampografia / Pad printing



- Antiaderenza
- Eccezionali prestazioni
- Facilità di cottura
- Facile sfornabilità e pulizia dopo l'uso
- Tortiere apribili con speciale fondo salvagoccia

- *Antiadhesion*
- *Outstanding performance*
- *Easy cooking*
- *Easy food release and cleaning after use*
- *Springforms with leakproof base*

Guardini®

MADE in ITALY

COM'È FATTO ? HOW IS IT MADE ?

Lo stampo da forno si compone di due parti:

- 1 • **SUBSTRATO: SUPPORTO IN ACCIAIO**
- 2 • **RIVESTIMENTO ANTIADERENTE (multistrato)**

The baking mould consists of two parts:

- 1 • **SUBSTRATE: MADE OF HI-TOP STEEL**
- 2 • **NON-STICK COATING (multilayer)**

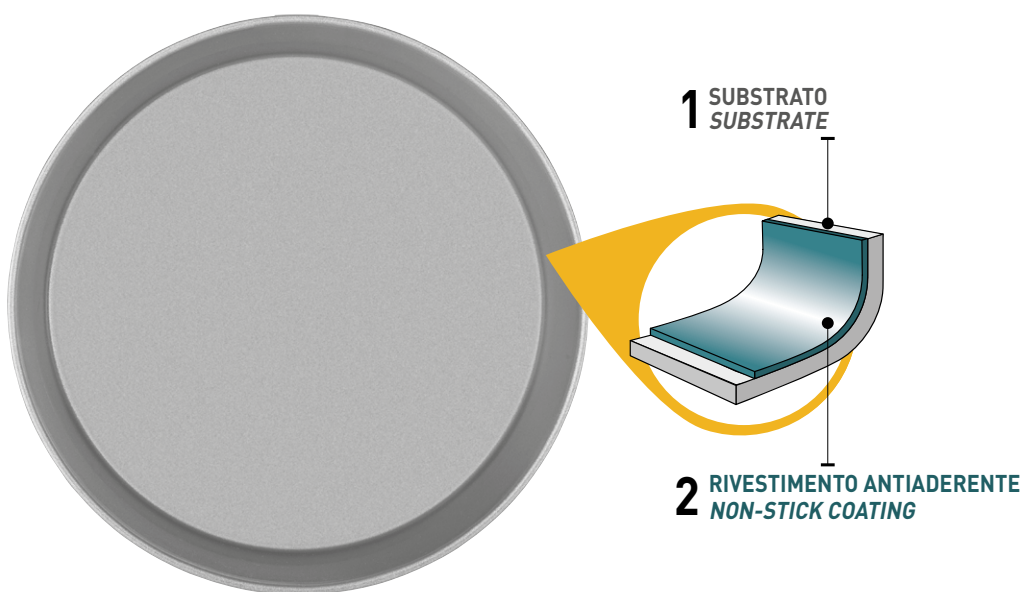

FACILE DA PULIRE
grazie all'ottima antiaderenza
EASY TO CLEAN
thanks to the excellent non-stick



RESISTENTE AI GRAFFI ED ALL'USURA
RESISTANT TO SCRATCHES AND USE

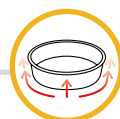

BASSO SPESSORE
per garantire un'ottima conducibilità termica
OPTIMIZED THICKNESS
guarantees excellent result for uniform cooking

1

Il substrato è realizzato in acciaio.

Il Substrato usato per la produzione degli stampi Guardini è **ECCS (Electrolytic Chromium Coated Steel)**:

- acciaio rivestito con un film di cromo;
- possiede ottime caratteristiche di resistenza alla corrosione e adesione al rivestimento;
- materiale molto elastico, qualità fondamentale per lo stampaggio;
- prodotto da acciaierie e utilizzato principalmente dai produttori europei di bakeware;
- può essere prodotto in spessori molto sottili, rendendo più adatto lo stampo alla cottura in forno.

The substrate is made of steel.

The Substrate used for the production of Guardini moulds is **ECCS (Electrolytic Chromium Coated Steel)**:

- steel coated with a chrome film;
- excellent corrosion resistance and coating adhesion properties;
- great flexibility;
- produced by tinplate mills and it is mostly used by European bakeware manufacturers;
- could be rolled at very thin gauges making it the most suitable material for cooking in the oven.

2

Caratteristiche del rivestimento antiaderente:

- bassa frizione;
- risulta essere liscio e ceroso al tatto;
- eccellente antiaderenza (l'efficacia si riduce lentamente);
- offre una buona barriera per la prevenzione delle macchie (inerte);
- alte qualità garantiscono una lunga vita del prodotto;
- buona adesione al metallo.

Characteristics of non-stick coating:

- lowest friction of any known solid;
- feels waxy and smooth to the touch;
- excellent release (effectiveness reduces slowly);
- offers good barrier to prevent staining - inert;
- premium grades offer long life;
- good adhesion to the metal.

Eccezionali prestazioni, facilità di cottura e di pulizia dopo l'uso: queste sono le caratteristiche che hanno reso le superfici antiaderenti famose in tutto il mondo.

I rivestimenti antiaderenti consentono di cucinare riducendo l'utilizzo di oli e di grassi, regole di base **per cucinare in modo sano e corretto**.

Outstanding performance, easy cooking and cleaning after use: these are the features that have made non-stick surfaces famous around the world.

The non-stick coatings permit to reduce the use of cooking oils and fats, a basic rule **for cooking in a healthy and correct way**.

Caratteristiche degli stampi con rivestimento antiaderente Characteristics of moulds with non-stick coating



Spessore ottimizzato

Minore è lo spessore dello stampo (risultando più leggero), maggiore sarà la qualità e l'uniformità della cottura. Questo perché lo stampo deve garantire il minimo ostacolo tra il composto contenuto all'interno e il forno, che è una camera chiusa dove avviene il processo della cottura.

Optimized thickness

The lower the thickness of the mould, therefore the lightness, the greater the quality and uniformity of the baking. This is because the mould must guarantee the minimum obstacle between the compound contained within it and the oven, which is a closed chamber where the cooking process takes place.

Cosa succede nel forno?

Quando una pietanza viene cotta in forno, sono coinvolti 2 fattori principali:

What happens in the oven?

When the food is put in a baking mould and placed in the oven for cooking, 2 main factors are involved:

Il forno è una camera termicamente isolata in cui il cibo viene cotto mediante **esposizione al calore**.

An oven is a thermally insulated chamber where the food is cooked by exposure to heat.

1
DIFFUSIONE
E CIRCOLAZIONE
DEL CALORE
**HEAT DIFFUSION
AND CIRCULATION**

2
CONDUZIONE
DEL CALORE
**HEAT
CONDUCTION**

È ottenuto attraverso il contatto diretto tra:

- un **corpo caldo** (stampo da forno);
- un **corpo freddo** (pietanza da cuocere).

It is obtained with direct contact between:

- a **hot body** (baking mould);
- a **cold body** (food).





MADE in ITALY

RIVESTIMENTO PRIVO DI BPA E PFOA

Da sempre tutti i **rivestimenti antiaderenti Guardini** sono assolutamente **affidabili** e adatti ad una **corretta alimentazione**, amici della salute e dell'ambiente.

- Sono **testati** ed **approvati** da istituti di controllo certificati, che applicano tutte le normative internazionali sui materiali destinati al contatto con gli alimenti.
- Consentono di cucinare con **meno grassi** a beneficio della salute.
- Sono **facili e veloci da pulire**, con minor spreco di acqua e di detersivo.
- I **cibi non attaccano** e non sviluppano quindi sostanze nocive, che potrebbero invece svilupparsi in caso di surriscaldamento e disidratazione di alcune sostanze alimentari.
- **Non contengono BPA (Bisfenolo A)**. L'azienda Guardini ha sostituito il BPA nella formulazione stessa di questi rivestimenti, eliminandolo definitivamente da tutti i materiali. Ha creato così una formulazione specifica di rivestimenti **"BPA FREE"**. Questo elemento sostitutivo inoltre ha permesso di migliorare notevolmente la qualità dei rivestimenti antiaderenti, in quanto:
 - riesce a creare una barriera tra il substrato dello stampo da forno ed il rivestimento che ne migliora le prestazioni di contatto alimentare evitando qualunque tipo di restrizione in riferimento agli alimenti utilizzati durante la cottura;
 - le proprietà di antiaderenza sono migliori e più performanti.
- **Non contengono PFOA**. Il Prof. Franco Battaglia, docente di chimica ambientale presso l'Università di Modena, ed il Prof. Gianni Fochi, docente di chimica presso la Scuola Normale Superiore di Pisa, hanno redatto un documento nato da un approfondito studio sui materiali antiaderenti, che **certifica l'assoluta idoneità dei rivestimenti antiaderenti in termini di sicurezza alimentare e rispetto dell'ambiente**.

COATING BPA AND PFOA FREE

- The **Guardini non-stick coatings** have always been health and environment's friends, are absolutely **reliable** and suitable for a **proper nutrition**.
- They are **tested and approved** by certified test institutes, which apply all the international rules on materials that are in contact with food.
- They allow you to cook with **less fat** for the benefit of health.
- They are **quick and easy to clean**, with less waste of water and detergent.
- The **food do not stick** to the moulds and thus they do not develop harmful substances that may originate in case of overheating and dehydration of some food products.
- **They don't contain BPA (Bisphenol A)**. Guardini replaced BPA in the formulation of these coatings, eliminating from all materials. Therefore, it created a specific formulation of **"BPA FREE"** coatings. Furthermore, this replacement has considerably improved the quality of non-stick coatings, inasmuch:
 - it can create a barrier between the substrate of the baking mould and the coating that improves the performance of food contact avoiding any type of restriction in reference to food used during cooking;
 - the non-stick properties are better and more efficient.
- **They don't contain PFOA**. Prof. Franco Battaglia, a professor of environmental chemistry at the University of Modena, and Prof. Gianni Fochi, professor of chemistry at the Scuola Normale Superiore di Pisa, have drawn up a document regarding a depth study of non-stick material, which **certify the absolute eligibility of non-stick coatings materials in terms of food security and environmental protection**.





Guardini



Temperatura
Temperature
Température



Antiaderenza
Non-stick
Antiadhérence



Strati antiaderente
Non-stick layers
Couches antiadhésives



Resistenza ai graffi
Scratch resistance
Résistance aux rayures



Garanzia
Warranty
Garantie





XBake



MORE INFO



XBake è la collezione di stampi da forno a **ridotto impatto ambientale**. Gli stampi da forno della linea XBake sono realizzati con un acciaio di supporto prodotto da **ArcelorMittal** proveniente da stabilimenti trasformati con tecnologie a **ridotta emissione di CO₂**, e per questo dotato del **"XCarb® green steel certificate"**, un marchio registrato da ArcelorMittal, che rappresenta il percorso intrapreso verso la **decarbonizzazione del processo produttivo dell'industria siderurgica**, contribuendo in modo significativo alla **riduzione delle emissioni di CO₂ in atmosfera**.

Il rivestimento antiaderente della collezione XBake è **privo di PTFE e di PFAS** ed è **rinforzato con particelle ceramiche**.

XBake rappresenta un'azione concreta di Guardini e della sua supply chain verso la **riduzione dell'impatto ambientale**.

XBake is the bakeware collection with a **reduced environmental impact**. The XBake moulds are made of a support steel provided by **ArcelorMittal** and coming from production processes transformed thanks to **sustainable innovative technologies** and therefore equipped with an **XCarb® green steel certificate**, a trademark registered by ArcelorMittal, which represents the path taken towards the **decarbonisation of the steel industry production process**, contributing significantly to the **reduction of the CO₂ emissions in the atmosphere**. The non-stick coating of the XBake collection is **PTFE and PFAS-free and it is reinforced with ceramic particles**.

XBake represents a concrete action of Guardini and its supply chain towards the **reduction of the environmental impact**.



VISTA FRONTE - FRONT VIEW

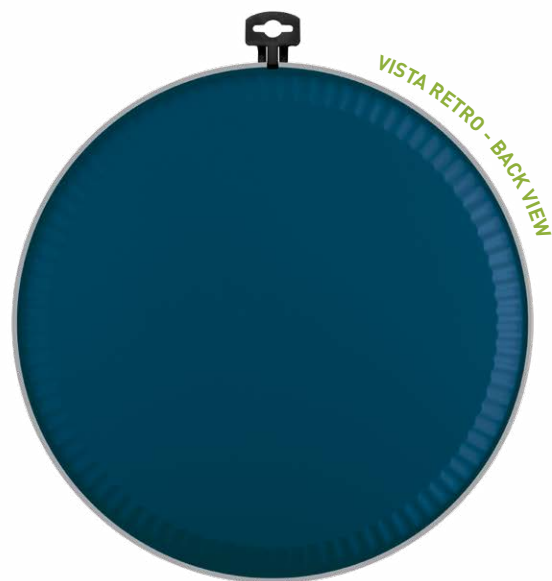

VISTA RETRO - BACK VIEW



MADE in ITALY

Tortiera apribile 2 fondi

Springform 2 bases
Moule démontable 2 fonds
Springform+Rohrboden
Molde desmontable 2 fondos



Speciale fondo salvagoccia
Leakproof base

CODE	CM	H CM	PACK	EAN
10026SGPBSGNAM	ø 26	7,7	6	8006043 019704

Confezione: etichetta e gancio / Packaging: label and plastic hook

Tortiera apribile 1 fondo

Springform 1 base
Moule démontable 1 fond
Springform
Molde desmontable 1 fondo



CODE	CM	H CM	PACK	EAN
10118PBSGNAM	ø 18	6,9	6	8006043 019711
10120PBSGNAM	ø 20	6,9	6	8006043 019728

Confezione: etichetta e gancio / Packaging: label and plastic hook

Tortiera apribile 1 fondo

Springform 1 base
Moule démontable 1 fond
Springform
Molde desmontable 1 fondo



CODE	CM	H CM	PACK	EAN
10122PBSGNAM	ø 22	6,9	6	8006043 019735

Confezione: etichetta e gancio / Packaging: label and plastic hook

Tortiera apribile 1 fondo

Springform 1 base
Moule à charnière carré
Springform
Molde desmontable 1 fondo



Speciale fondo salvagoccia
Leakproof base

CODE	CM	H CM	PACK	EAN
10124SGPBSGNAM	ø 24	7,6	6	8006043 019742
10126SGPBSGNAM	ø 26	7,6	6	8006043 019759

Confezione: etichetta e gancio / Packaging: label and plastic hook

Stampo apribile quadrato

Square springform
Moule à charnière carré
Springform quadratisch
Molde desmontable cuadrado



Speciale fondo salvagoccia
Leakproof base

CODE	CM	H CM	PACK	EAN
14524PBSAPRGNAM	24 x 24	7	6	8006043 019766

Confezione: etichetta e gancio / Packaging: label and plastic hook

Stampo apribile rettangolare

Rectangle cake pan
Moule à charnière rectangulaire
Springform rechteckig
Molde desmontable rectangular

 Speciale fondo salvagoccia
Leakproof base



CODE	CM	H CM	PACK	EAN
13519PBSAPRGNAM	19 x 28	7	6	8006043 019773

Confezione: etichetta e gancio / Packaging: label and plastic hook

Stampo apribile per plumcake

Loaf springform pan
Moule à charnière rectangulaire
Springform Königs-kuchen
Molde desmontable para plumcake

 Speciale fondo salvagoccia
Leakproof base



CODE	CM	H CM	PACK	EAN
13030PBSAPRGNAM	30 x 11	7	6	8006043 019780

Confezione: etichetta e gancio / Packaging: label and plastic hook

Tortiera liscia

Round cake tin
Moule à clafoutis
Kuchenform
Molde alto



CODE	CM	H CM	PACK	EAN
10426PBSGNAM	ø 26	5,2	6	8006043 019797

Confezione: etichetta e gancio / Packaging: label and plastic hook

Stampo crostata

Flan tin
Moule à tarte
Obsttortenboden
Molde rizado



CODE	CM	H CM	PACK	EAN
11028FPPBSGNAM	ø 28	4	6	8006043 019803

Confezione: etichetta e gancio / Packaging: label and plastic hook

Stampo ciambella

Savarin cake pan
Moule à savarin
Kranzform
Molde savarin



CODE	CM	H CM	PACK	EAN
11525PBSGNAM	ø 25	8	6	8006043 019810

Confezione: etichetta e gancio / Packaging: label and plastic hook

Stampo budino con cono

Bundtform
Kugelhopf
Gugelhupf
Flanera con cono



CODE	CM	H CM	PACK	EAN
12123PBSEE	ø 23	12	6	8006043 019827

Confezione: etichetta / Packaging: label

Tegame pizza

Pizza tin
Plaque à pizza
Pizzaform
Molde para pizza



CODE	CM	H CM	PACK	EAN
12532PBSGNAM	ø 32	1,5	6	8006043 019834

Confezione: etichetta e gancio / Packaging: label and plastic hook

Stampo plumcake

Loaf tin
Moule à cake
Königskuchenform
Molde plumcake



CODE	CM	H CM	PACK	EAN
13025PBSGNAM	25 x 11	6,4	6	8006043 019841

Confezione: etichetta e gancio / Packaging: label and plastic hook

Teglia rettangolare

Baking sheet
Plaque à four rectangulaire
Herbackblech
Bandeja rectangular



CODE	CM	H CM	PACK	EAN
13526PBSGNAM	26 x 37	2,1	6	8006043 019858

Confezione: etichetta e gancio / Packaging: label and plastic hook

Lasagnera

Bake & roast pan
Plat à four
Auflaufform
Rustidera



CODE	CM	H CM	PACK	EAN
14022PBSGNAM	22 x 28	4,7	6	8006043 019865
14024PBSGNAM	24 x 32	4,7	6	8006043 019872

Confezione: etichetta e gancio / Packaging: label and plastic hook

Stampo 12 muffins

12 Muffins tray
Plaque à 12 muffins
12 Muffinform
Molde muffin 12 pzas



CODE	CM	H CM	PACK	EAN
14912PBSGNAM	27 x 35	3	6	8006043 019889

Confezione: etichetta e gancio / Packaging: label and plastic hook

XBake è il frutto della preziosa collaborazione lungo la filiera produttiva, tra partners con la stessa visione e lo stesso obiettivo: realizzare una collezione di stampi da forno con un ridotto impatto sull'ambiente, a testimonianza del fatto che unendo le forze lungo la filiera si può davvero diventare più sostenibili. Questa collezione è realizzata con un acciaio di supporto prodotto da ArcelorMittal e proveniente da processi produttivi trasformati grazie a tecnologie innovative sostenibili e per questo dotato di un certificato XCarb®, che ne attesta la ridotta impronta carbonica. Il rivestimento antiaderente di XBake è stato realizzato da ILAG ed è privo di PTFE e PFAS, frutto di una nuova tecnologia che è riuscita ad eliminare questi componenti chimici dal processo produttivo e quindi dall'ambiente.



XBake is the result of a fruitful collaboration along the supply chain, between partners with a common purpose: the creation of a baking moulds collection with a reduced impact on the environment. This testifies that by joining forces along the supply chain, we can truly become more sustainable. This collection is made of a support steel provided by ArcelorMittal and coming from production processes transformed thanks to sustainable innovative technologies and therefore equipped with an XCarb® green steel certificate, which certifies its reduced carbon footprint. The XBake non-stick coating was made by ILAG and it is PTFE and PFAS-free, the result of a new technology that has succeeded in eliminating these chemical components from the production process and therefore from the environment.

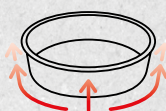

Lo spessore dell'acciaio è ottimizzato per la forma e l'applicazione per **garantire eccellenti prestazioni di cottura**. In questo modo si evita l'uso eccessivo di acciaio e si **ottimizza il trasferimento di calore, il che porta a un risparmio energetico**. Il processo di produzione è ottimizzato nella resa del materiale e gli scarti di acciaio del processo di produzione vengono riciclati per produrre nuovo acciaio.

The thickness of the steel is optimized to the shape and application to **guarantee excellent cooking performance**. In this way, excess use of steel is avoided and heat transfer is **optimized which is leading to energy saving**. The production process is optimized in material yield and steel scrap from the production process is recycled to produce new steel.

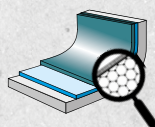

Il **rivestimento antiaderente** è applicato con tecnologia "coil coating" che ne **elimina la dispersione nell'ambiente e garantisce una copertura uniforme** su tutta la superficie dello stampo per **elevate prestazioni antiaderenti e una maggiore durata del prodotto**. La **facile pulizia** dello stampo dopo l'uso consente inoltre di **risparmiare acqua e detersivi chimici**.

The **non-stick coating** is applied with "coil coating" technology which **eliminates its dispersion in the environment and guarantees uniform coverage** over the entire surface of the mould for **high non-stick performance and a longer product life cycle**. The **easy cleaning** of the mould after use also **saves water and chemical detergents**.



Il **packaging** del prodotto è rigorosamente **certificato FSC®**, ossia da foreste gestite in modo responsabile.

The **product packaging** is strictly **FSC® certified**.



La **produzione degli stampi da forno** è **100% Made in Italy** e proviene da una **filiera di fornitura italiana ed europea**.

The **baking moulds production** is **100% Made in Italy** and comes from an **Italian and European supply chain**.



Guardini



Temperatura
Temperature
Température



Antiaderenza
Non-stick
Antiadhérence



Strati antiaderente
Non-stick layers
Couches antiadhésives



Resistenza ai graffi
Scratch resistance
Résistance aux rayures



Garanzia
Warranty
Garantie





Bnat

BAKE NATURAL

4 ACTIONS
MORE
SUSTAINABLE IMPACT

MORE
INFO



La gamma **B-Nat** è una linea di stampi da forno realizzata in acciaio Hi-Top con rivestimento antiaderente doppio strato a base di **CERA DI CARNAUBA**.

Grazie alla **scivolosità** conferita dalla cera di carnauba, il rivestimento risulta così **naturalmente antiaderente**.

The **B-Nat** range is a line of baking moulds made of Hi-Top steel with a double layer of non-stick coating with **CARNAUBA WAX**.

The carnauba wax gives a **slippery** effect creating a truly **natural non-stick** coating.



La cera di carnauba si ricava dalle foglie della palma *Copernicia prunifera* ed è quindi frutto del naturale processo di cerificazione attuato dalla pianta. La cerificazione è una modificazione che subisce la superficie della foglia per aumentare la propria impermeabilità durante la stagione delle piogge. Questa cera, naturalmente prodotta, viene raccolta durante la stagione secca, sotto forma di scaglie. Ampiamente utilizzata in svariati settori, viene usata nella produzione del rivestimento antiaderente della linea B-Nat, conferendo agli stampi una maggiore lucentezza, per stampi naturalmente antiaderenti.

The Carnauba wax is obtained from the leaves of the *Copernicia prunifera* and it is the result of the natural process of wax production generated by the tree. The wax is produced thanks to the modification of the surface of the leaf to increase its impermeability during the rainy season. This wax, produced naturally, is collected during the dry season in the form of flakes. Widely used in different sectors, it is employed in the production of the non-stick coating of the range B-Nat, giving the moulds more brightness, for naturally non-stick moulds.



Tortiera apribile 2 fondi

Springform 2 bases
Moule démontable 2 fonds
Springform+Rohrboden
Molde desmontable 2 fondos

 Speciale fondo salvagoccia
Leakproof base



CODE	CM	H CM	PACK	EAN
35026CARGNAM	ø 26	7,7	6	8006043 015379

Confezione: etichetta e gancio / Packaging: label and plastic hook

Tortiera apribile 1 fondo

Springform 1 base
Moule démontable 1 fond
Springform
Molde desmontable 1 fondo



CODE	CM	H CM	PACK	EAN
35122CARGNAM	ø 22	6,9	6	8006043 015331

Confezione: etichetta e gancio / Packaging: label and plastic hook

Tortiera apribile 1 fondo

Springform 1 base
Moule démontable 1 fond
Springform
Molde desmontable 1 fondo



 Speciale fondo salvagoccia
Leakproof base

CODE	CM	H CM	PACK	EAN
35124CARGNAM	ø 24	7,6	6	8006043 015348
35126CARGNAM	ø 26	7,6	6	8006043 015355

Confezione: etichetta e gancio / Packaging: label and plastic hook

Tortiera liscia

Round cake tin
Moule à clafoutis
Kuchenform
Molde alto



CODE	CM	H CM	PACK	EAN
35428CARGNAM	ø 28	5,2	6	8006043 015386

Confezione: etichetta e gancio / Packaging: label and plastic hook

Stampo crostata

Flan tin
Moule à tarte
Obsttortenboden
Molde rizado



CODE	CM	H CM	PACK	EAN
36028FCARGNAM	ø 28	4	6	8006043 015409

Confezione: etichetta e gancio / Packaging: label and plastic hook

4 crostatine

Set of 4 pie tins
Lot 4 tartelettes
4 Torteletts
Juego de 4 moldes tartaletas



CODE	CM	H CM	PACK	EAN
36204CARVEE	ø 12	1,9	6	8006043 019124

Confezione: fascia in cartoncino appendibile
Packaging: with hangable carton label

Stampo ciambella

Savarin cake pan
Moule à savarin
Kranzform
Molde savarin



CODE	CM	H CM	PACK	EAN
36525CARGNAM	ø 25	8	6	8006043 015416

Confezione: etichetta e gancio / Packaging: label and plastic hook

Stampo budino con cono

Bundtform
Kugelhupf
Gugelhupf
Flanera con cono



CODE	CM	H CM	PACK	EAN
37123CAREE	ø 23	12	6	8006043 015423

Confezione: etichetta / Packaging: label

Stampo plumcake

Loaf tin
Moule à cake
Königskuchenform
Molde plumcake



CODE	CM	H CM	PACK	EAN
38025CARGNAM	25 x 11	6,4	6	8006043 015430
38030CARGNAM	30 x 11	6,4	6	8006043 015447

Confezione: etichetta e gancio / Packaging: label and plastic hook

Stampo quadro

Square cake tin
Moule carré
Quadratische Backform
Molde cuadrado



CODE	CM	H CM	PACK	EAN
39524CARGNAM	24 x 24	4,5	6	8006043 015454

Confezione: etichetta e gancio / Packaging: label and plastic hook

Stampo 6 muffins

6 Muffins tray
Plaque à 6 muffins
6 Muffinform
Molde muffin 6 pzas



CODE	CM	H CM	PACK	EAN
39906CARGNAM	18,5 x 27	2,9	6	8006043 019209

Confezione: etichetta e gancio / Packaging: label and plastic hook

Stampo 12 muffins

12 Muffins tray
Plaque à 12 muffins
12 Muffinform
Molde muffin 12 pzas



CODE	CM	H CM	PACK	EAN
39912CARGNAM	27 x 35	3	6	8006043 015478

Confezione: etichetta e gancio / Packaging: label and plastic hook

Teglia da forno piatta

Cookie sheet - Plaque à biscuits
Backblech flach - Bandeja para galletas

CODE	CM	H CM	PACK	EAN
38735CARGNAM	35 x 40	0,2	6	8006043 015461

Confezione: etichetta e gancio / Packaging: label and plastic hook

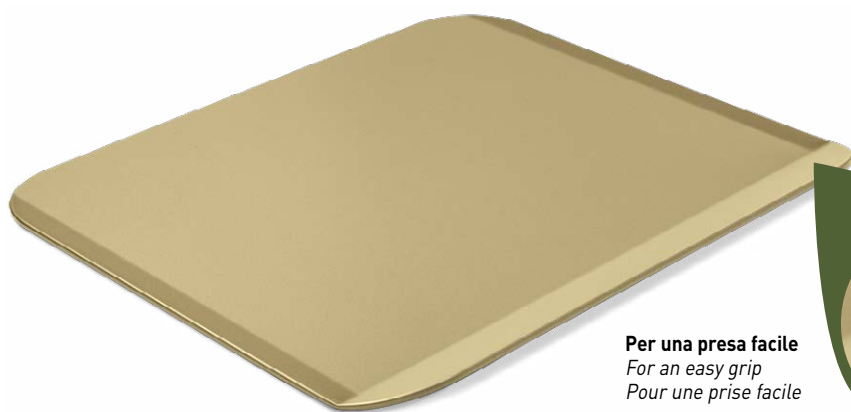

Per una presa facile
For an easy grip
Pour une prise facile

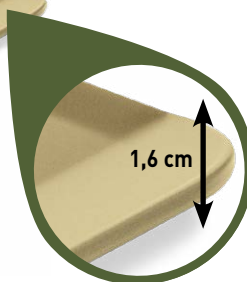

MULTIUSO - MULTIPURPOSE





Guardini





Gold Elegance



La gamma Gold Elegance è una linea elegante e dalle alte prestazioni, con i suoi colori champagne (per il rivestimento interno antiaderente) e bronzo (per la colorazione esterna).

La linea Gold Elegance è realizzata in acciaio Hi-Top con rivestimento antiaderente interno doppio strato. È una linea elegante e dalle alte prestazioni di antiaderenza, resistenza ai graffi e all'usura.

The Gold Elegance range is one of the most stylish, with its combination of external bronze colour and champagne coloured internal non-stick coating.

This line is made of Hi-Top steel with a double layer of non-stick coating. Its elegance is combined with high quality non-stick performances, ease of cooking and cleaning after use.



Gli stampi della linea Gold Elegance sono personalizzati sul fondo dello stampo* con il logo Guardini e la scritta **Made in Italy**, realizzati tramite la tecnologia laser.

*Eccetto lo Stampo ciambella e lo Stampo budino con cono.

The moulds of the Gold Elegance line are customized on the bottom of the mould* with the **Guardini logo** and **Made in Italy**, made using laser technology.

*Except the Savarin cake pan and Bundtform.



Tortiera apribile 2 fondi

Springform 2 bases
Moule démontable 2 fonds
Springform+Rohrboden
Molde desmontable 2 fondos



Speciale fondo salvagoccia
Leakproof base

CODE	CM	H CM	PACK	EAN
70026GEGNAM	ø 26	7,7	6	8006043 014716

Confezione: etichetta e gancio / Packaging: label and plastic hook

Tortiera apribile 1 fondo

Springform 1 base
Moule démontable 1 fond
Springform
Molde desmontable 1 fondo



Speciale fondo salvagoccia
Leakproof base

CODE	CM	H CM	PACK	EAN
70124GEGNAM	ø 24	7,6	6	8006043 015171
70126GEGNAM	ø 26	7,6	6	8006043 014723
70128GEGNAM	ø 28	7,6	6	8006043 015188

Confezione: etichetta e gancio / Packaging: label and plastic hook

Tortiera liscia

Round cake tin
Moule à clafoutis
Kuchenform
Molde alto



CODE	CM	H CM	PACK	EAN
70428GEGNAM	ø 28	5,2	6	8006043 014730

Confezione: etichetta e gancio / Packaging: label and plastic hook

Tortiera fiorella

Fiorella cake tin
Moule à manqué
Fiorella kuchenform
Molde Fiorella



CODE	CM	H CM	PACK	EAN
70526GEGNAM	ø 26	6,8	6	8006043 015096

Confezione: etichetta e gancio / Packaging: label and plastic hook

Stampo crostata

Flan tin
Moule à tarte
Obsttortenboden
Molde rizado



CODE	CM	H CM	PACK	EAN
71028FPGEGNAM	ø 28	4	6	8006043 014747

Confezione: etichetta e gancio / Packaging: label and plastic hook

Stampo ciambella

Savarin cake pan
Moule à savarin
Kranzform
Molde savarin



CODE	CM	H CM	PACK	EAN
71525GEGNAM	ø 25	8	6	8006043 015102

Confezione: etichetta e gancio / Packaging: label and plastic hook

Stampo budino con cono

Bundtform
Kugelhupf
Gugelhupf
Flanera con cono



CODE	CM	H CM	PACK	EAN
72123GEEE	ø 23	12	6	8006043 014754

Confezione: etichetta / Packaging: label

Tegame pizza

Pizza tin
Plaque à pizza
Pizzaform
Molde para pizza



CODE	CM	H CM	PACK	EAN
72532GEGNAM	ø 32	1,5	6	8006043 015119

Confezione: etichetta e gancio / Packaging: label and plastic hook

Stampo plumcake

Loaf tin
Moule à cake
Königskuchenform
Molde plumcake



CODE	CM	H CM	PACK	EAN
73025GEGNAM	25 x 11	6,4	6	8006043 014761

Confezione: etichetta e gancio / Packaging: label and plastic hook

Teglia rettangolare

Baking sheet
Plaque à four rectangulaire
Herdbackblech
Bandeja rectangular



CODE	CM	H CM	PACK	EAN
73526GEGNAM	26 x 37	2,1	6	8006043 014785

Confezione: etichetta e gancio / Packaging: label and plastic hook

Lasagnera

Bake & roast pan
Plat à four
Auflaufform
Rustidera



CODE	CM	H CM	PACK	EAN
74024GEGNAM	24 x 32	4,7	6	8006043 014792

Confezione: etichetta e gancio / Packaging: label and plastic hook

Stampo 12 muffins

12 Muffins tray
Plaque à 12 muffins
12 Muffinform
Molde muffin 12 pzas



CODE	CM	H CM	PACK	EAN
79912GEGNAM	27 x 35	3	6	8006043 014808

Confezione: etichetta e gancio / Packaging: label and plastic hook





Guardini



Temperatura
Temperature
Température



Antiaderenza
Non-stick
Antiadhérence



Strati antiaderente
Non-stick layers
Couches antiadhésives



Resistenza ai graffi
Scratch resistance
Résistance aux rayures



Garanzia
Warranty
Garantie





Silver Elegance



La linea **Silver Elegance** è una linea di stampi da forno **realizzata in acciaio con rivestimento antiaderente interno doppio strato**. Il rivestimento antiaderente è **PFAS-free**. È una linea elegante e dalle alte prestazioni.

The **Silver Elegance** range is **made of Hi-Top steel with a double layer of non-stick coating**. The non-stick coating is **PFAS-free**. Its elegance is combined with high quality non-stick performances, ease of cooking and cleaning after use.



Gli stampi della linea Silver Elegance sono personalizzati sul fondo dello stampo* con il **logo Guardini** e la scritta **Made in Italy**, realizzati tramite la tecnologia **laser**.

*Eccetto lo Stampo ciambella e lo Stampo budino con cono.

The moulds of the Silver Elegance line are customized on the bottom of the mould* with the **Guardini logo** and **Made in Italy**, made using **laser technology**.

*Except the Savarin cake pan and Bundtform.



Tortiera apribile 2 fondi

Springform 2 bases
Moule démontable 2 fonds
Springform+Rohrboden
Molde desmontable 2 fondos

 Speciale fondo salvagoccia
Leakproof base



CODE	CM	H CM	PACK	EAN
70026SE1GNAM	ø 26	7,7	6	8006043 023343

Confezione: etichetta e gancio / Packaging: label and plastic hook

Tortiera apribile 1 fondo

NEW

Springform 1 base
Moule démontable 1 fond
Springform
Molde desmontable 1 fondo



CODE	CM	H CM	PACK	EAN
70118SE1GNAM	ø 18	6,9	6	8006043 023350
70120SE1GNAM	ø 20	6,9	6	8006043 023367

Confezione: etichetta e gancio / Packaging: label and plastic hook

Tortiera apribile 1 fondo

Springform 1 base
Moule démontable 1 fond
Springform
Molde desmontable 1 fondo



CODE	CM	H CM	PACK	EAN
70122SE1GNAM	ø 22	6,9	6	8006043 023374

Confezione: etichetta e gancio / Packaging: label and plastic hook

Tortiera apribile 1 fondo

Springform 1 base
Moule démontable 1 fond
Springform
Molde desmontable 1 fondo

 Speciale fondo salvagoccia
Leakproof base



CODE	CM	H CM	PACK	EAN
70124SE1GNAM	ø 24	7,6	6	8006043 023381
70126SE1GNAM	ø 26	7,6	6	8006043 023398
70128SE1GNAM	ø 28	7,6	6	8006043 023404

Confezione: etichetta e gancio / Packaging: label and plastic hook

Stampo apribile quadrato

NEW

Square springform
Moule à charnière carré
Springform quadratisch
Molde desmontable cuadrado

 Speciale fondo salvagoccia
Leakproof base



CODE	CM	H CM	PACK	EAN
74524APRSE1GNAM	24 x 24	7	6	8006043 019636

Confezione: etichetta e gancio / Packaging: label and plastic hook

Stampo apribile rettangolare

NEW

Rectangle cake pan
Moule à charnière rectangulaire
Springform rechteckig
Molde desmontable rectangular



 Speciale fondo salvagoccia
Leakproof base

CODE	CM	H CM	PACK	EAN
73519APRSE1GNAM	19 x 28	7	6	8006043 019643

Confezione: etichetta e gancio / Packaging: label and plastic hook

Stampo apribile per plumcake

NEW

Loaf springform pan
Moule à charnière rectangulaire
Springform Königs-kuchen
Molde desmontable para plumcake



 Speciale fondo salvagoccia
Leakproof base

CODE	CM	H CM	PACK	EAN
73030APRSE1GNAM	30 x 11	7	6	8006043 019650

Confezione: etichetta e gancio / Packaging: label and plastic hook

Tortiera liscia

Round cake tin
Moule à clafoutis
Kuchenform
Molde alto



CODE	CM	H CM	PACK	EAN
70428SE1GNAM	ø 28	5,2	6	8006043 023442

Confezione: etichetta e gancio / Packaging: label and plastic hook

Stampo crostata

Flan tin
Moule à tarte
Obsttortenboden
Molde rizado



CODE	CM	H CM	PACK	EAN
71028FPSE1GNAM	ø 28	4	6	8006043 023459

Confezione: etichetta e gancio / Packaging: label and plastic hook

4 crostatine

Set of 4 pie tins
Lot 4 tartelettes
4 Torteletts
Juego de 4 moldes tartaletas



CODE	CM	H CM	PACK	EAN
71204SE1VEE	ø 12	1,9	6	8006043 023466

Confezione: fascia in cartoncino appendibile
Packaging: with hangable carton label

Stampo ciambella

Savarin cake pan
Moule à savarin
Kranzform
Molde savarin



CODE	CM	H CM	PACK	EAN
71525SE1GNAM	ø 25	8	6	8006043 023473

Confezione: etichetta e gancio / Packaging: label and plastic hook

Stampo budino con cono

Bundtform
Kugelhupf
Gugelhupf
Flanera con cono



CODE	CM	H CM	PACK	EAN
72123SE1EE	ø 23	12	6	8006043 023480

Confezione: etichetta / Packaging: label

Tegame pizza

Pizza tin
Plaque à pizza
Pizzaform
Molde para pizza



CODE	CM	H CM	PACK	EAN
72532SE1GNAM	ø 32	1,5	6	8006043 023497

Confezione: etichetta e gancio / Packaging: label and plastic hook

Tegame pizza surgelata

Frozen pizza tin
Plaque à pizza surgelée
Pizzaform
Molde para pizza congelada



CODE	CM	H CM	PACK	EAN
72732SE1GNAM	ø 32	1,5	6	8006043 023503

Confezione: etichetta e gancio / Packaging: label and plastic hook

Stampo plumcake

Loaf tin
Moule à cake
Königskuchenform
Molde plumcake



CODE	CM	H CM	PACK	EAN
73025SE1GNAM	25 x 11	6,4	6	8006043 023510
73030SE1GNAM	30 x 11	6,4	6	8006043 023527

Confezione: etichetta e gancio / Packaging: label and plastic hook

Teglia rettangolare

Baking sheet
Plaque à four rectangulaire
Herbackblech
Bandeja rectangular



CODE	CM	H CM	PACK	EAN
73526SE1GNAM	26 x 37	2,1	6	8006043 023534
73532SE1GNAM	32 x 37	2,1	6	8006043 023541

Confezione: etichetta e gancio / Packaging: label and plastic hook

Lasagnera

Bake & roast pan
Plat à four
Auflaufform
Rustidera



CODE	CM	H CM	PACK	EAN
74022SE1GNAM	22 x 28	4,7	6	8006043 023589
74024SE1GNAM	24 x 32	4,7	6	8006043 023596

Confezione: etichetta e gancio / Packaging: label and plastic hook

Stampo quadro

Square cake tin
Moule carré
Quadratische Backform
Molde cuadrado



CODE	CM	H CM	PACK	EAN
74524SE1GNAM	24 x 24	4,5	6	8006043 023411

Confezione: etichetta e gancio / Packaging: label and plastic hook

Stampo 12 muffins

12 Muffins tray
Plaque à 12 muffins
12 Muffinform
Molde muffin 12 pzas



CODE	CM	H CM	PACK	EAN
79912SE1GNAM	27 x 35	3	6	8006043 023428

Confezione: etichetta e gancio / Packaging: label and plastic hook

Teglia da forno piatta

Cookie sheet - Plaque à biscuits
Backblech flach - Bandeja para galletas



Per una presa facile
For an easy grip
Pour une prise facile

CODE	CM	H CM	PACK	EAN
73735SE1GNAM	35 x 40	0,2	6	8006043 023435

Confezione: etichetta e gancio / Packaging: label and plastic hook



MULTIUSO - MULTIPURPOSE



Guardini



Temperatura
Temperature
Température



Antiaderenza
Non-stick
Antiadhérence



Strati antiaderente
Non-stick layers
Couches antiadhésives



Resistenza ai graffi
Scratch resistance
Résistance aux rayures



Garanzia
Warranty
Garantie





Arianna



Un'ampia e diversificata gamma di stampi da forno, per cucinare con calore e fantasia dolci, pizze, arrostiti e lasagne, arricchendo i momenti trascorsi in famiglia o con gli amici di allegria e convivialità.

Realizzata in acciaio Hi-Top con rivestimento antiaderente doppio strato, la linea Arianna rappresenta la tradizione di casa Guardini. Eccellenti caratteristiche di antiaderenza e di conducibilità termica, fanno di questa linea un'ottima soluzione per ottenere risultati perfetti di cottura e di sformabilità.

Il rivestimento antiaderente di qualità, studiato appositamente per gli stampi da forno, garantisce la facile sformatura del dolce e la totale pulizia dello stampo dopo l'uso.

A wide and miscellaneous bakeware range for baking desserts, pizza, lasagna, roasts with love and creativity, to enjoy spending time with family and friends.

Made of Hi-Top steel with a double layer of non-stick coating, the Arianna range represents the Guardini tradition.

Excellent non-stick and thermal conductivity properties, make this line a great way to obtain perfect cooking and food release.

The quality of non-stick coating, specially studied for bakeware, ensures an easy food release and cleanup.



VISTA FRONTE - FRONT VIEW



Ricetta sul retro
Recipe on the back

VISTA RETRO - BACK VIEW

MADE in ITALY

Tortiera apribile 2 fondi

Springform 2 bases
Moule démontable 2 fonds
Springform+Rohrboden
Molde desmontable 2 fondos

 Speciale fondo salvagoccia
Leakproof base



CODE	CM	H CM	PACK	EAN
55024	ø 24	7,7	6	8006043 550245
55026	ø 26	7,7	6	8006043 550269
55028	ø 28	7,7	6	8006043 550283

Confezione: fascia in cartoncino con gancio
Packaging: carton sleeve with plastic hook

Tortiera apribile 1 fondo

Springform 1 base
Moule démontable 1 fond
Springform
Molde desmontable 1 fondo

 Speciale fondo salvagoccia
Leakproof base



CODE	CM	H CM	PACK	EAN
55124	ø 24	7,6	6	8006043 551242
55126	ø 26	7,6	6	8006043 551266
55128	ø 28	7,6	6	8006043 551280

Confezione: fascia in cartoncino con gancio
Packaging: carton sleeve with plastic hook

Tortiera liscia

Round cake tin
Moule à clafoutis
Kuchenform
Molde alto



CODE	CM	H CM	PACK	EAN
55428	ø 28	5,2	6	8006043 554281

Confezione: fascia in cartoncino con gancio
Packaging: carton sleeve with plastic hook

Tortiera fiorella

Fiorella cake tin
Moule à manqué
Fiorella kuchenform
Molde Fiorella



CODE	CM	H CM	PACK	EAN
55526	ø 26	6,8	6	8006043 555264

Confezione: fascia in cartoncino con gancio
Packaging: carton sleeve with plastic hook

Stampo cuore

Heart shaped cake tin
Moule à coeur
Herzorten boden
Molde corazón



CODE	CM	H CM	PACK	EAN
55800	25 x 25	4,4	6	8006043 558005

Confezione: fascia in cartoncino con gancio
Packaging: carton sleeve with plastic hook

Stampo crostata

Flan tin
Moule à tarte
Obsttortenboden
Molde rizado



CODE	CM	H CM	PACK	EAN
56028FP	ø 28	4	6	8006043 560282

Confezione: fascia in cartoncino con gancio
Packaging: carton sleeve with plastic hook

4 crostatine

Set of 4 pie tins
Lot 4 tartelettes
4 Torteletts
Juego de 4 moldes tartaletas



CODE	CM	H CM	PACK	EAN
56204	ø 12	1,9	6	8006043 562040

Confezione: fascia in cartoncino appendibile
Packaging: with hangable carton label

Stampo ciambella

Savarin cake pan
Moule à savarin
Kranzform
Molde savarin



CODE	CM	H CM	PACK	EAN
56525	ø 25	8	6	8006043 565256

Confezione: fascia in cartoncino con gancio
Packaging: carton sleeve with plastic hook

Tegame pizza

Pizza tin
Plaque à pizza
Pizzaform
Molde para pizza



CODE	CM	H CM	PACK	EAN
57528	ø 28	1,5	6	8006043 575286
57532	ø 32	1,5	6	8006043 575323

Confezione: fascia in cartoncino con gancio
Packaging: carton sleeve with plastic hook

Stampo plumcake

Loaf tin
Moule à cake
Königskuchenform
Molde plumcake



CODE	CM	H CM	PACK	EAN
58025	25 x 11	6,4	6	8006043 580259
58030	30 x 11	6,4	6	8006043 580303

Confezione: fascia in cartoncino con gancio
Packaging: carton sleeve with plastic hook

Teglia rettangolare

*Baking sheet
Plaque à four rectangulaire
Herbackblech
Bandeja rectangular*



CODE	CM	H CM	PACK	EAN
58526	26 x 37	2,1	6	8006043 585261
58532	32 x 37	2,1	6	8006043 585322

Confezione: fascia in cartoncino con gancio
Packaging: carton sleeve with plastic hook

Lasagnera

*Bake & roast pan
Plat à four
Auflaufform
Rustidera*



CODE	CM	H CM	PACK	EAN
59022	22 x 28	4,7	6	8006043 590227
59024	24 x 32	4,7	6	8006043 590241

Confezione: fascia in cartoncino con gancio
Packaging: carton sleeve with plastic hook

Stampo quadro

*Square cake tin
Moule carré
Quadratische Backform
Molde cuadrado*



CODE	CM	H CM	PACK	EAN
59524	24 x 24	4,5	6	8006043 595246

Confezione: fascia in cartoncino con gancio
Packaging: carton sleeve with plastic hook

Stampo 12 muffins

*12 Muffins tray
Plaque à 12 muffins
12 Muffinform
Molde muffin 12 pzas*



CODE	CM	H CM	PACK	EAN
59912	27 x 35	3	6	8006043 599121

Confezione: fascia in cartoncino con gancio
Packaging: carton sleeve with plastic hook





Guardini

**230°C
MAX**

Temperatura
Temperature
Température



Antiaderenza
Non-stick
Antiadhérence



Strati antiaderente
Non-stick layers
Couches antiadhésives



Resistenza ai graffi
Scratch resistance
Résistance aux rayures



Garanzia
Warranty
Garantie





GARDENIA



Con una straordinaria vastità di gamma, la linea Gardenia offre alla fantasia del consumatore mille modi di esprimersi.

Realizzata in acciaio Hi-Top, con rivestimento antiaderente doppio strato, la linea Gardenia garantisce risultati perfetti di cottura ed antiaderenza.

La particolare conducibilità termica dell'acciaio utilizzato garantisce cotture in forno rapide ed uniformi di cibi dolci e salati. Il rivestimento antiaderente doppio strato, appositamente studiato per gli stampi da forno, assicura la facile sfornatura del dolce e la totale pulizia dello stampo dopo l'uso.

The Gardenia range offers the customers a thousand ways to be creative in the kitchen, thanks to a huge variety of shapes.

Made of Hi-Top steel with double layer of non-stick coating, the Gardenia line ensures the perfect non-sticking results. The excellent thermal conductivity of the steel ensures rapid and equable cooking of sweet and savoury recipes.

The non-stick coating, specially studied for bakeware, makes the food release and the cleanup easy.



MADE in ITALY

Tortiera apribile 2 fondi

Springform 2 bases
Moule démontable 2 fonds
Springform+Rohrboden
Molde desmontable 2 fondos

 Speciale fondo salvagoccia
Leakproof base



CODE	CM	H CM	PACK	EAN
85024E	ø 24	7,7	6	8006043 850246
85026E	ø 26	7,7	6	8006043 850260
85028E	ø 28	7,7	6	8006043 850284

Confezione: etichetta / Packaging: label

Tortiera apribile 2 fondi

Springform 2 bases
Moule démontable 2 fonds
Springform+Rohrboden
Molde desmontable 2 fondos



CODE	CM	H CM	PACK	EAN
85030E	ø 30	7,7	6	8006043 850307

Confezione: etichetta / Packaging: label

Tortiera apribile 1 fondo

Springform 1 base
Moule démontable 1 fond
Springform
Molde desmontable 1 fondo



CODE	CM	H CM	PACK	EAN
85112NEE	ø 12	4,2	6	8006043 010978
85116NEE	ø 16	4,3	6	8006043 010985
85118TEE	ø 18	6,9	6	8006043 017250
85120TEE	ø 20	6,9	6	8006043 010992

Confezione: etichetta / Packaging: label

Tortiera apribile 1 fondo

Springform 1 base
Moule démontable 1 fond
Springform
Molde desmontable 1 fondo



CODE	CM	H CM	PACK	EAN
85120FAEE	ø 20	8,5	6	8006043 018592

Confezione: etichetta / Packaging: label



**BORDO ALTO
EXTRA HIGH RING
REBORD TRES HAUT**

Tortiera apribile 1 fondo

Springform 1 base
Moule démontable 1 fond
Springform
Molde desmontable 1 fondo



CODE	CM	H CM	PACK	EAN
85122E	ø 22	6,9	6	8006043 851229

Confezione: etichetta / Packaging: label

Tortiera apribile 1 fondo

Springform 1 base
Moule démontable 1 fond
Springform
Molde desmontable 1 fondo

 Speciale fondo salvagoccia
Leakproof base



CODE	CM	H CM	PACK	EAN
85124E	ø 24	7,6	6	8006043 851243
85126E	ø 26	7,6	6	8006043 851267
85128E	ø 28	7,6	6	8006043 851281

Confezione: etichetta / Packaging: label

Tortiera apribile 1 fondo

Springform 1 base
Moule démontable 1 fond
Springform
Molde desmontable 1 fondo



CODE	CM	H CM	PACK	EAN
85130E	ø 30	7,6	6	8006043 851304

Confezione: etichetta / Packaging: label

Stampo apribile quadrato

Square springform
Moule à charnière carré
Springform quadratisch
Molde desmontable cuadrado

 Speciale fondo salvagoccia
Leakproof base



CODE	CM	H CM	PACK	EAN
89524APRTEE	24 x 24	7	6	8006043 015256

Confezione: etichetta / Packaging: label

Stampo apribile rettangolare

Rectangle cake pan
Moule à charnière rectangulaire
Springform rechteckig
Molde desmontable rectangular

 Speciale fondo salvagoccia
Leakproof base



CODE	CM	H CM	PACK	EAN
88519APRTEE	19 x 28	7	6	8006043 015263

Confezione: etichetta / Packaging: label

Stampo apribile per plumcake

Loaf springform pan
Moule à charnière rectangulaire
Springform Königsuchen
Molde desmontable para plumcake

 Speciale fondo salvagoccia
Leakproof base



CODE	CM	H CM	PACK	EAN
88030APRTEE	30 x 11	7	6	8006043 015270

Confezione: etichetta / Packaging: label

Tortiera liscia

Round cake tin
Moule à clafoutis
Kuchenform
Molde alto



CODE	CM	H CM	PACK	EAN
85426EE	ø 26	5,2	6	8006043 019148
85428EE	ø 28	5,2	6	8006043 854282
85432EE	ø 32	5,2	6	8006043 012705

Confezione: etichetta / Packaging: label

Tortiera fiorella

Fiorella cake tin
Moule à manqué
Fiorella kuchenform
Molde Fiorella



CODE	CM	H CM	PACK	EAN
85526EE	ø 26	6,8	6	8006043 855265

Confezione: etichetta / Packaging: label

Tortiera fiorella con cono

Savarin cake tin
Moule à savarin
Briocheform
Molde Fiorella con cono



CODE	CM	H CM	PACK	EAN
85626EE	ø 26	7,9	6	8006043 856262

Confezione: etichetta / Packaging: label

Stampo cuore

Heart shaped cake tin
Moule à coeur
Herzorten boden
Molde corazón



CODE	CM	H CM	PACK	EAN
85800EE	25 x 25	4,4	6	8006043 858006

Confezione: etichetta / Packaging: label

Stampo crostata

Flan tin
Moule à tarte
Obsttortenboden
Molde rizado



CODE	CM	H CM	PACK	EAN
86024FP EE	ø 24	4	6	8006043 860245
86028FP EE	ø 28	4	6	8006043 860283

Confezione: etichetta / Packaging: label

Stampo per crostata morbida

Tart pan for soft cakes
Moule pour gâteaux moelleux
Obstkuchenform
Molde para tartas de fruta



CODE	CM	H CM	PACK	EAN
86028EE	ø 28	4	6	8006043 015294

Confezione: etichetta / Packaging: label



Stampo crostata con fondo smontabile

Loose base flan tin
Moule à tarte avec fond amovible
Obsttorten mit abnehmbar boden
Molde rizado móvil



CODE	CM	H CM	PACK	EAN
86128EE	ø 28	4	6	8006043 861280

Confezione: etichetta / Packaging: label

4 crostatine

Set of 4 pie tins
Lot 4 tartelettes
4 Torteletts
Juego de 4 moldes tartaletas



CODE	CM	H CM	PACK	EAN
86204EE	ø 12	1,9	6	8006043 862041

Confezione: fascia in cartoncino appendibile / Packaging: with hangable carton label

Stampo ciambella

Savarin cake pan
Moule à savarin
Kranzform
Molde savarin



CODE	CM	H CM	PACK	EAN
86525EE	ø 25	8	6	8006043 865257

Confezione: etichetta / Packaging: label

Stampo budino

Brioche tin
Moule à brioche
Briocheform
Flanera rizada



CODE	CM	H CM	PACK	EAN
87022EE	ø 22	9,3	6	8006043 870220

Confezione: etichetta / Packaging: label

Stampo budino con cono

Bundtform
Kugelhupf
Gugelhupf
Flanera con cono



CODE	CM	H CM	PACK	EAN
87123EE	ø 23	12	6	8006043 872231

Confezione: etichetta / Packaging: label

Tegame pizza

Pizza tin
Plaque à pizza
Pizzaform
Molde para pizza



CODE	CM	H CM	PACK	EAN
87528EE	ø 28	1,5	6	8006043 875287
87532EE	ø 32	1,5	6	8006043 875324

Confezione: etichetta / Packaging: label

Tegame pizza

Pizza tin
Plaque à pizza
Pizzaform
Molde para pizza



CODE	CM	H CM	PACK	EAN
87537EE	ø 37	3	6	8006043 016543

Confezione: etichetta / Packaging: label

Stampo plumcake

Loaf tin
Moule à cake
Königskuchenform
Molde plumcake



CODE	CM	H CM	PACK	EAN
88020EE	21 x 10	5,9	6	8006043 880205

Confezione: etichetta / Packaging: label

Stampo plumcake

Loaf tin
Moule à cake
Königskuchenform
Molde plumcake



CODE	CM	H CM	PACK	EAN
88025EE	25 x 11	6,4	6	8006043 880250
88030EE	30 x 11	6,4	6	8006043 880304

Confezione: etichetta / Packaging: label

Teglia rettangolare

Baking sheet
Plaque à four rectangulaire
Herbackblech
Bandeja rectangular



CODE	CM	H CM	PACK	EAN
88520EE	31 x 20,5	2,6	6	8006043 019667

Confezione: etichetta / Packaging: label

Teglia rettangolare

Baking sheet
Plaque à four rectangulaire
Herbackblech
Bandeja rectangular



CODE	CM	H CM	PACK	EAN
88526EE	26 x 37	2,1	6	8006043 885262
88532EE	32 x 37	2,1	6	8006043 885323

Confezione: etichetta / Packaging: label

Lasagnera NEW

Bake & roast pan
Plat à four
Auflaufform
Rustidera



CODE	CM	H CM	PACK	EAN
89020EE	20 x 25	3,2	6	8006043 890204

Confezione: etichetta / Packaging: label

Lasagnera

Bake & roast pan
Plat à four
Auflaufform
Rustidera



CODE	CM	H CM	PACK	EAN
89022EE	22 x 28	4,7	6	8006043 890228
89024EE	24 x 32	4,7	6	8006043 890242
89030EE	30 x 40	5,3	6	8006043 890303

Confezione: etichetta / Packaging: label

Rostiera

Roast pan
Plat à four
Auflaufform
Rustidera



CODE	CM	H CM	PACK	EAN
88528EE	35 x 27,5	4,5	6	8006043 018905

Confezione: etichetta / Packaging: label

Rostiera con grill

Roast pan with grill rack
Plat à four avec grille
Auflaufform mit Grilleinsatz
Rustidera con parrilla



CODE	CM	H CM	PACK	EAN
89025E	24 x 32	5,3	6	8006043 890259

Confezione: etichetta / Packaging: label

Stampo quadro

Square cake tin
Moule carré
Quadratische Backform
Molde cuadrado



CODE	CM	H CM	PACK	EAN
89524EE	24 x 24	4,5	6	8006043 895247

Confezione: etichetta / Packaging: label

Stampo 6 muffins

6 Muffins tray
Plaque à 6 muffins
6 Muffinform
Molde muffin 6 pzas



CODE	CM	H CM	PACK	EAN
89906EE	18,5 x 27	2,9	6	8006043 899061

Confezione: etichetta / Packaging: label

Stampo 6 muffins + 30 pirottini di carta

6 Muffins tray
+ 30 paper bun cases
Plaque à 6 muffins
+ 30 barquettes papier
6 Muffinform + 30 papierback-förmchen
Molde 6 muffin + 30 moldes pastelito



CODE	CM	H CM	PACK	EAN
89907	18,5 x 27	2,9	12	8006043 899078

Confezione: film termoretrato + etichetta / Packaging: heat-shrunk film + label

Stampo 12 muffins

12 Muffins tray
Plaque à 12 muffins
12 Muffinform
Molde muffin 12 pzas



CODE	CM	H CM	PACK	EAN
89912EE	27 x 35	3	6	8006043 899122

Confezione: etichetta / Packaging: label

Stampo 12 muffins + 60 pirottini di carta

12 Muffins tray
+ 60 paper bun cases

Plaque à 12 muffins
+ 60 barquettes papier

12 Muffinform
+ 60 papierback-förmchen

Molde 12 muffin + 60 moldes pastelito



CODE	CM	H CM	PACK	EAN
89913	27 x 35	3	12	8006043 899139

Confezione: film termoretrato + etichetta / Packaging: heat-shrunk film + label

Teglia rettangolare **estensibile**

Adjustable baking tray - Plaque à four rectangulaire extensible
Ausziehbare Backform - Bandeja rectangular extensible



CODE	CM	H CM	PACK	EAN
88634EE1	33,3 x 38	3	6	8006043 886344
	33,3 x 51,3			

Confezione: etichetta / Packaging: label



MULTIUSO - MULTIPURPOSE

Teglia da forno piatta

Cookie sheet - Plaque à biscuits
Backblech flach - Bandeja para galletas



Per una presa facile
For an easy grip
Pour une prise facile

CODE	CM	H CM	PACK	EAN
88735EE	35 x 40	0,2	6	8006043 015249

Confezione: etichetta / Packaging: label



MULTIUSO - MULTIPURPOSE



Guardini



Temperatura
Temperature
Température



Antiaderenza
Non-stick
Antiadhérence



Strati antiaderente
Non-stick layers
Couches antiadhésives



Resistenza ai graffi
Scratch resistance
Résistance aux rayures



Garanzia
Warranty
Garantie





Bon Ton



La collezione Bon Ton, dai colori tenui e provenzali, è composta da teglie tanto belle da vedere, quanto resistenti e pratiche da usare.

Le numerose forme sono realizzate in acciaio Hi-Top con rivestimento antiaderente doppio strato. Le teglie da forno della linea Bon Ton garantiscono risultati perfetti di cottura ed antiaderenza. Grazie alla particolare conducibilità termica dell'acciaio utilizzato e al suo basso spessore, la cottura in forno di tutti i cibi, dolci e salati, risulta rapida ed uniforme.

Il rivestimento antiaderente di qualità assicura ottimi risultati nella sfornatura del dolce e nella cottura di piatti salati, garantendo inoltre la facilità nella pulizia dello stampo dopo l'uso.

The Bon Ton collection has soft and provençal colours, all baking moulds are so beautiful to see, as strong and practical to use.

Bon Ton moulds are made of Hi-Top steel with a double layer of non-stick coating. Bon Ton moulds ensure perfect baking and non-stick results. The excellent heat distribution and low thickness of the steel allows uniform and rapid baking of any sweet and savoury dish. The quality non-stick coating ensures excellent results in cooking, food release and cleanup.

VISTA FRONTE - FRONT VIEW



VISTA RETRO - BACK VIEW



Colori / Colors:



PALE GREEN



PINK LILAC



MADE in ITALY

Tortiera apribile 1 fondo con cono

Springform with tube base
Moule démontable
Springform
Molde desmontable

 Speciale fondo salvagoccia
Leakproof base



CODE	CM	H CM	PACK	EAN
● 70226PAGBHEE	ø 26	7,7	6	8006043 016864
● 70226PKLBHEE				

Confezione: etichetta / Packaging: label

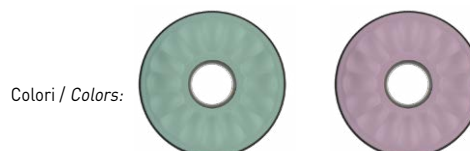

Tortiera apribile 1 fondo

Springform 1 base
Moule démontable 1 fond
Springform
Molde desmontable 1 fondo

 Speciale fondo salvagoccia
Leakproof base



CODE	CM	H CM	PACK	EAN
● 70126PAGBHEE	ø 26	7,6	6	8006043 016871
● 70126PKLBHEE				

Confezione: etichetta / Packaging: label



Tortiera liscia

Round cake tin
Moule à clafoutis
Kuchenform
Molde alto



CODE	CM	H CM	PACK	EAN
● 70428PAGBHEE	ø 28	5,2	6	8006043 016888
● 70428PKLBHEE				

Confezione: etichetta / Packaging: label



Tortiera fiorella

Fiorella cake tin
Moule à manqué
Fiorella kuchenform
Molde Fiorella



CODE	CM	H CM	PACK	EAN
● 70526PAGBHEE	ø 26	6,8	6	8006043 016895
● 70526PKLBHEE				

Confezione: etichetta / Packaging: label



Stampo cuore

Heart shaped cake tin
Moule à coeur
Herzorten boden
Molde corazón



CODE	CM	H CM	PACK	EAN
● 70800PAGBHEE	25 x 25	4,4	6	8006043 016901
● 70800PKLBHEE				

Confezione: etichetta / Packaging: label

Colori / Colors:



Stampo crostata

Flan tin
Moule à tarte
Obsttortenboden
Molde rizado



CODE	CM	H CM	PACK	EAN
● 71028FPAGBHEE	ø 28	4	6	8006043 016918
● 71028FPKLBHEE				

Confezione: etichetta / Packaging: label

Colori / Colors:



Stampo budino con cono

Bundtform
Kugelhupf
Gugelhupf
Flanera con cono



CODE	CM	H CM	PACK	EAN
● 72123PAGBHEE	ø 23	12	6	8006043 016925
● 72123PKLBHEE				

Confezione: etichetta / Packaging: label

Colori / Colors:



Stampo plumcake

Loaf tin
Moule à cake
Königskuchenform
Molde plumcake



CODE	CM	H CM	PACK	EAN
● 73025PAGBHEE	25 x 11	6,4	6	8006043 016932
● 73025PKLBHEE				

Confezione: etichetta / Packaging: label

Colori / Colors:



Lasagnera

Bake & roast pan
Plat à four
Auflaufform
Rustidera



CODE	CM	H CM	PACK	EAN
● 74022PAGBHEE	22 x 28	4,7	6	8006043 016949
● 74022PKLBHEE				

Confezione: etichetta / Packaging: label

Colori / Colors:



Stampo quadro

Square cake tin
Moule carré
Quadratische Backform
Molde cuadrado



CODE	CM	H CM	PACK	EAN
● 74524PAGBHEE	24 x 24	4,5	6	8006043 016956
● 74524PKLBHEE				

Confezione: etichetta / Packaging: label

Colori / Colors:



Stampo 12 muffins

12 Muffins tray
Plaque à 12 muffins
12 Muffinform
Molde muffin 12 pzas



CODE	CM	H CM	PACK	EAN
● 74912PAGBHEE	27 x 35	3	6	8006043 016963
● 74912PKLBHEE				

Confezione: etichetta / Packaging: label

Colori / Colors:







Guardini



Temperatura
Temperature
Température



Antiaderenza
Non-stick
Antiadhérence



Strati antiaderente
Non-stick layers
Couches antiadhésives



Resistenza ai graffi
Scratch resistance
Résistance aux rayures



Garanzia
Warranty
Garantie





Chocoforme



Chocoforme è una linea di stampi dal doppio colore. Il rivestimento esterno color cioccolato e l'antiaderente color crema all'interno fanno della linea Chocoforme un'ottima idea per creare i propri dolci in stampi da forno assolutamente... golosi.

Realizzati in acciaio Hi-Top con rivestimento antiaderente doppio strato, gli stampi da forno della linea Chocoforme garantiscono ottimi risultati di cottura e antiaderenza.

Questo tipo di rivestimento è caratterizzato da ottime proprietà antiaderenti, che ne rendono facile la pulizia dopo l'uso.

Grazie anche alla notevole resistenza alle abrasioni, è consigliato per un uso intensivo e di alto livello.

Chocoforme is a two-tone range of moulds, coated externally with chocolate colour and internally with non-stick cream colour. Chocoforme allows to bake delicious cakes... in delicious tins.

Made of Hi-Top steel with a double layer of non-stick coating, Chocoforme moulds ensure perfect baking results and excellent food release. Thanks to the perfect heat distribution of the steel and to its low thickness, the baking performances are increased. This type of coating ensures excellent non-stick properties, ease of cooking and cleaning after use.

Thanks to its abrasion resistance this coating is ideal for intensive use.

VISTA FRONTE - FRONT VIEW



VISTA RETRO - BACK VIEW

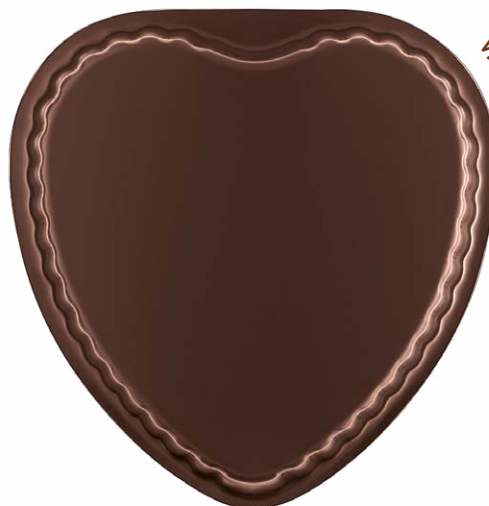

MADE in ITALY

Tortiera apribile 1 fondo

Springform 1 base
Moule démontable 1 fond
Springform
Molde desmontable 1 fondo

 Speciale fondo salvagoccia
Leakproof base



CODE	CM	H CM	PACK	EAN
00701H	ø 26	7,6	6	8006043 000313

Confezione: etichetta / Packaging: label

Tortiera liscia

Round cake tin
Moule à clafoutis
Kuchenform
Molde alto



CODE	CM	H CM	PACK	EAN
00704H	ø 28	5,2	24	8006043 000337

Confezione: etichetta / Packaging: label

Tortiera fiorella

Fiorella cake tin
Moule à manqué
Fiorella kuchenform
Molde Fiorella



CODE	CM	H CM	PACK	EAN
00705H	ø 26	6,8	24	8006043 000344

Confezione: etichetta / Packaging: label

Stampo cuore

Heart shaped cake tin
Moule à coeur
Herzorten boden
Molde corazón



CODE	CM	H CM	PACK	EAN
00708H	25 x 25	4,4	24	8006043 000351

Confezione: etichetta / Packaging: label

Stampo crostata

Flan tin
Moule à tarte
Obsttortenboden
Molde rizado



CODE	CM	H CM	PACK	EAN
00710FPH	ø 28	4	24	8006043 000368

Confezione: etichetta / Packaging: label

Stampo ciambella

Savarin cake pan
Moule à savarin
Kranzform
Molde savarin



CODE	CM	H CM	PACK	EAN
00715H	ø 25	8	24	8006043 000375

Confezione: etichetta / Packaging: label

Stampo budino

Brioche tin
Moule à brioche
Briocheform
Flanera rizada



CODE	CM	H CM	PACK	EAN
00720H	ø 22	9,3	24	8006043 000382

Confezione: etichetta / Packaging: label

Stampo plumcake

Loaf tin
Moule à cake
Königskuchenform
Molde plumcake



CODE	CM	H CM	PACK	EAN
00730H	25 x 11	6,4	24	8006043 000399

Confezione: etichetta / Packaging: label

Teglia rettangolare

Baking sheet
Plaque à four rectangulaire
Herbackblech
Bandeja rectangular



CODE	CM	H CM	PACK	EAN
00735H	26 x 37	2,1	24	8006043 000405

Confezione: etichetta / Packaging: label

Teglia multiuso

Bake & roast pan
Plat à four
Auflaufform
Rustidera



CODE	CM	H CM	PACK	EAN
00740H	22 x 28	4,7	24	8006043 000412

Confezione: etichetta / Packaging: label

Stampo quadro

Square cake tin
Moule carré
Quadratische Backform
Molde cuadrado



CODE	CM	H CM	PACK	EAN
00745H	24 x 24	4,5	24	8006043 000429

Confezione: etichetta / Packaging: label

Stampo 6 muffins

6 Muffins tray
Plaque à 6 muffins
6 Muffinform
Molde muffin 6 pzas



CODE	CM	H CM	PACK	EAN
00748H	18,5 x 27	2,9	24	8006043 006308

Confezione: etichetta / Packaging: label

Stampo 12 muffins

12 Muffins tray
Plaque à 12 muffins
12 Muffinform
Molde muffin 12 pzas



CODE	CM	H CM	PACK	EAN
00749H	27 x 35	3	24	8006043 006315

Confezione: etichetta / Packaging: label

Set 3 stampi da forno

Set of 3 non-stick coating moulds
Lot de 3 moules à gâteaux
anti-adhérents
Backformen-set (3 tlg)
Set 3 moldes en acero antiadherente



CODE	CM	PACK	EAN
00737H	30 x 30 x 13,5	4	8006043 000573

Confezione: scatola / Packaging: box
Per maggiori dettagli: vedi pag. 164 / For more details: see page 164





Guardini



Temperatura
Temperature
Température



Antiaderenza
Non-stick
Antiadhérence



Strati antiaderente
Non-stick layers
Couches antiadhésives



Resistenza ai graffi
Scratch resistance
Résistance aux rayures



Garanzia
Warranty
Garantie





HAPPY HOUR



Con un'ampia varietà di forme, la gamma Happy Hour è perfetta per cucinare con allegria grazie alla perfetta antiaderenza del rivestimento.

Realizzati in acciaio Hi-Top con rivestimento antiaderente doppio strato, gli stampi da forno della linea Happy Hour sono il frutto di una ricerca avanzata in tema di rivestimenti antiaderenti e garantiscono risultati perfetti di cottura ed antiaderenza. Il basso spessore dell'acciaio utilizzato consente l'uniforme diffusione del calore, garantendo una cottura rapida e perfetta.

With a wide variety of shapes, the Happy Hour range is perfect for cooking with joy thanks to the perfect non-stick coating.

Made of Hi-Top steel with a double layer of non-stick coating, Happy Hour provides perfect baking results and easy food release. The low thickness of the steel allows perfect heat distribution, providing quick and excellent baking results.

VISTA FRONTE - FRONT VIEW



VISTA RETRO - BACK VIEW

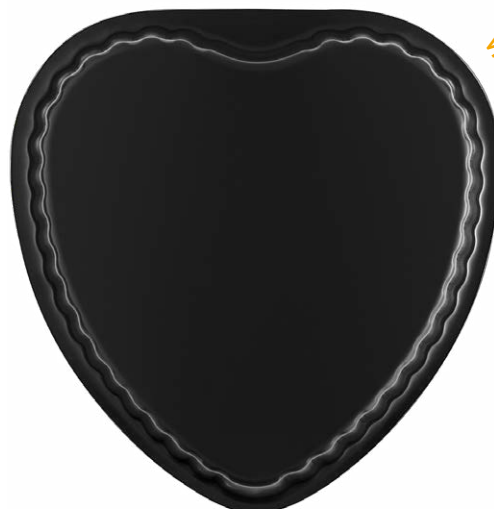

MADE in ITALY

Tortiera apribile 2 fondi

Springform 2 bases
Moule démontable 2 fonds
Springform+Rohrboden
Molde desmontable 2 fondos



CODE	CM	H CM	PACK	EAN
05024HEE	ø 24	6,9	6	8006043 016598
05026HEE	ø 26	6,9	6	8006043 016604
05028HEE	ø 28	6,9	6	8006043 016611

Confezione: etichetta / Packaging: label

Tortiera apribile 1 fondo

Springform 1 base
Moule démontable 1 fond
Springform
Molde desmontable 1 fondo



CODE	CM	H CM	PACK	EAN
05124HEE	ø 24	6,8	6	8006043 016628
05126HEE	ø 26	6,8	6	8006043 016635
05128HEE	ø 28	6,8	6	8006043 016642

Confezione: etichetta / Packaging: label

Tortiera liscia

Round cake tin
Moule à clafoutis
Kuchenform
Molde alto



CODE	CM	H CM	PACK	EAN
05428HEE	ø 28	5,2	6	8006043 016659
05432HEE	ø 32	5,2	6	8006043 016666

Confezione: etichetta / Packaging: label

Tortiera fiorella

Fiorella cake tin
Moule à manqué
Fiorella kuchenform
Molde Fiorella



CODE	CM	H CM	PACK	EAN
05526HEE	ø 26	6,8	6	8006043 016673

Confezione: etichetta / Packaging: label

Tortiera fiorella con cono

Savarin cake tin
Moule à savarin
Briocheform
Molde Fiorella con cono



CODE	CM	H CM	PACK	EAN
05626HEE	ø 26	7,9	6	8006043 016680

Confezione: etichetta / Packaging: label

Stampo cuore

Heart shaped cake tin
Moule à cœur
Herzorten boden
Molde corazón



CODE	CM	H CM	PACK	EAN
05800HEE	25 x 25	4,4	6	8006043 016697

Confezione: etichetta / Packaging: label

Stampo crostata

Flan tin
Moule à tarte
Obsttortenboden
Molde rizado



CODE	CM	H CM	PACK	EAN
06028FPHEE	ø 28	4	6	8006043 016703
06030FPHEE	ø 30	4	6	8006043 016710

Confezione: etichetta / Packaging: label

Stampo ciambella

Savarin cake pan
Moule à savarin
Kranzform
Molde savarin



CODE	CM	H CM	PACK	EAN
06525HEE	ø 25	8	6	8006043 016727

Confezione: etichetta / Packaging: label

Tegame pizza

Pizza tin
Plaque à pizza
Pizziform
Molde para pizza



CODE	CM	H CM	PACK	EAN
07528HEE	ø 28	1,5	6	8006043 016734
07532HEE	ø 32	1,5	6	8006043 016741
07537HEE	ø 37	3	6	8006043 016758

Confezione: etichetta / Packaging: label

Stampo plumcake

Loaf tin
Moule à cake
Königskuchenform
Molde plumcake



CODE	CM	H CM	PACK	EAN
08025HEE	25 x 11	6,4	6	8006043 016765
08030HEE	30 x 11	6,4	6	8006043 016772

Confezione: etichetta / Packaging: label

Teglia rettangolare

Baking sheet
Plaque à four rectangulaire
Herbackblech
Bandeja rectangular



CODE	CM	H CM	PACK	EAN
08526HEE	26 x 37	2,1	6	8006043 016789
08532HEE	32 x 37	2,1	6	8006043 016796

Confezione: etichetta / Packaging: label

Lasagnera

Bake & roast pan
Plat à four
Auflaufform
Rustidera



CODE	CM	H CM	PACK	EAN
09022HEE	22 x 28	4,7	6	8006043 016802
09024HEE	24 x 32	4,7	6	8006043 016819
09030HEE	30 x 40	5,3	6	8006043 016826

Confezione: etichetta / Packaging: label

Stampo quadro

Square cake tin
Moule carré
Quadratische Backform
Molde cuadrado



CODE	CM	H CM	PACK	EAN
09524HEE	24 x 24	4,5	6	8006043 016833

Confezione: etichetta / Packaging: label

Stampo 12 muffins

12 Muffins tray
Plaque à 12 muffins
12 Muffinform
Molde muffin 12 pzas



CODE	CM	H CM	PACK	EAN
09912HEE	27 x 35	3	6	8006043 016840

Confezione: etichetta / Packaging: label





Guardini



Temperatura
Temperature
Température



Antiaderenza
Non-stick
Antiadhérence



Strati antiaderente
Non-stick layers
Couches antiadhésives



Resistenza ai graffi
Scratch resistance
Résistance aux rayures



Garanzia
Warranty
Garantie





Rossana



Ampia e colorata gamma di stampi da forno in rosso vivo, la linea Rossana comunica tutta la fantasia e la passione per la cucina al forno. Le numerose forme sono realizzate in acciaio Hi-Top con rivestimento antiaderente doppio strato. Le teglie da forno della linea Rossana garantiscono risultati perfetti di cottura ed antiaderenza. Grazie alla particolare conducibilità termica dell'acciaio utilizzato e al suo basso spessore, la cottura in forno di tutti i cibi, dolci e salati, risulta rapida ed uniforme. Il rivestimento antiaderente di qualità assicura ottimi risultati nella sfornatura del dolce e nella cottura di piatti salati, garantendo inoltre la facilità nella pulizia dello stampo dopo l'uso.

A broad colourful range of bakeware in bright red, the Rossana line conveys all the imagination and passion for baking.

Rossana moulds are made of Hi-Top steel with a double layer of non-stick coating. They ensure perfect baking and non-stick results. The excellent heat distribution and low thickness of the steel allows uniform and rapid baking of any sweet and savoury dish. The quality non-stick coating ensures excellent results in cooking, food release and cleanup.



Tortiera apribile 2 fondi

Springform 2 bases
Moule démontable 2 fonds
Springform+Rohrboden
Molde desmontable 2 fondos

 Speciale fondo salvagoccia
Leakproof base



CODE	CM	H CM	PACK	EAN
50024HGNAM	ø 24	7,7	6	8006043 016994
50026HGNAM	ø 26	7,7	6	8006043 017007
50028HGNAM	ø 28	7,7	6	8006043 017014

Confezione: etichetta e gancio / Packaging: label and plastic hook

Tortiera apribile 1 fondo

NEW

Springform 1 base
Moule démontable 1 fond
Springform
Molde desmontable 1 fondo



CODE	CM	H CM	PACK	EAN
50118HGNAM	ø 18	6,9	6	8006043 019674
50120HGNAM	ø 20	6,9	6	8006043 019681

Confezione: etichetta e gancio / Packaging: label and plastic hook

Tortiera apribile 1 fondo

Springform 1 base
Moule démontable 1 fond
Springform
Molde desmontable 1 fondo



CODE	CM	H CM	PACK	EAN
50122HGNAM	ø 22	6,9	6	8006043 018370

Confezione: etichetta e gancio / Packaging: label and plastic hook

Tortiera apribile 1 fondo

Springform 1 base
Moule démontable 1 fond
Springform
Molde desmontable 1 fondo

 Speciale fondo salvagoccia
Leakproof base



CODE	CM	H CM	PACK	EAN
50124HGNAM	ø 24	7,6	6	8006043 017021
50126HGNAM	ø 26	7,6	6	8006043 017038
50128HGNAM	ø 28	7,6	6	8006043 017045

Confezione: etichetta e gancio / Packaging: label and plastic hook

Stampo apribile quadrato

NEW

Square springform
Moule à charnière carré
Springform quadratisch
Molde desmontable cuadrado

 Speciale fondo salvagoccia
Leakproof base



CODE	CM	H CM	PACK	EAN
54524HAPRGNAM	24 x 24	7	6	8006043 018547

Confezione: etichetta e gancio / Packaging: label and plastic hook

Stampo apribile rettangolare

NEW

Rectangle cake pan
Moule à charnière rectangulaire
Springform rechteckig
Molde desmontable rectangular



Speciale fondo salvagoccia
Leakproof base

CODE	CM	H CM	PACK	EAN
53519HAPRGNAM	19 x 28	7	6	8006043 018530

Confezione: etichetta e gancio / Packaging: label and plastic hook

Stampo apribile per plumcake

NEW

Loaf springform pan
Moule à charnière rectangulaire
Springform Königs-kuchen
Molde desmontable para plumcake



Speciale fondo salvagoccia
Leakproof base

CODE	CM	H CM	PACK	EAN
53030HAPRGNAM	30 x 11	7	6	8006043 018523

Confezione: etichetta e gancio / Packaging: label and plastic hook

Tortiera liscia

Round cake tin
Moule à clafoutis
Kuchenform
Molde alto



CODE	CM	H CM	PACK	EAN
50428HGNAM	ø 28	5,2	6	8006043 017052

Confezione: etichetta e gancio / Packaging: label and plastic hook

Tortiera fiorella

Fiorella cake tin
Moule à manqué
Fiorella kuchenform
Molde Fiorella



CODE	CM	H CM	PACK	EAN
50526HGNAM	ø 26	6,8	6	8006043 017069

Confezione: etichetta e gancio / Packaging: label and plastic hook

Stampo cuore

Heart shaped cake tin
Moule à coeur
Herzorten boden
Molde corazón



CODE	CM	H CM	PACK	EAN
50800HGNAM	25 x 25	4,4	6	8006043 017083

Confezione: etichetta e gancio / Packaging: label and plastic hook

Stampo crostata

Flan tin
Moule à tarte
Obsttortenboden
Molde rizado



CODE	CM	H CM	PACK	EAN
51028FPHGNAM	ø 28	4	6	8006043 017090

Confezione: etichetta e gancio / Packaging: label and plastic hook

4 crostatine

Set of 4 pie tins
Lot 4 tartelettes
4 Torteletts
Juego de 4 moldes tartaletas



CODE	CM	H CM	PACK	EAN
51204HV	ø 12	1,9	6	8006043 017106

Confezione: fascia in cartoncino appendibile / Packaging: with hangable carton label

Stampo ciambella

Savarin cake pan
Moule à savarin
Kranzform
Molde savarin



CODE	CM	H CM	PACK	EAN
51525HGAM	ø 25	8	6	8006043 017113

Confezione: etichetta e gancio / Packaging: label and plastic hook

Stampo budino

Brioche tin
Moule à brioche
Briocheform
Flanera rizada



CODE	CM	H CM	PACK	EAN
52022HGNA	ø 22	9,3	6	8006043 017120

Confezione: etichetta / Packaging: label

Stampo budino con cono

Bundtform
Kugelhopf
Gugelhupf
Flanera con cono



CODE	CM	H CM	PACK	EAN
52123HGAM	ø 23	12	6	8006043 017137

Confezione: etichetta e gancio / Packaging: label and plastic hook

Tegame pizza

Pizza tin
Plaqué à pizza
Pizzaform
Molde para pizza



CODE	CM	H CM	PACK	EAN
52528HGNAM	ø 28	1,5	6	8006043 017144
52532HGNAM	ø 32	1,5	6	8006043 017151

Confezione: etichetta e gancio / Packaging: label and plastic hook

Stampo plumcake

Loaf tin
Moule à cake
Königskuchenform
Molde plumcake



CODE	CM	H CM	PACK	EAN
53025HGNAM	25 x 11	6,4	6	8006043 017168
53030HGNAM	30 x 11	6,4	6	8006043 017175

Confezione: etichetta e gancio / Packaging: label and plastic hook

Teglia rettangolare

Baking sheet
Plaqué à four rectangulaire
Herdbackblech
Bandeja rectangular



CODE	CM	H CM	PACK	EAN
53526HGNAM	26 x 37	2,1	6	8006043 017182
53532HGNAM	32 x 37	2,1	6	8006043 017199

Confezione: etichetta e gancio / Packaging: label and plastic hook

Lasagnera

Bake & roast pan
Plat à four
Auflaufform
Rustidera



CODE	CM	H CM	PACK	EAN
54022HGNAM	22 x 28	4,7	6	8006043 017205
54024HGNAM	24 x 32	4,7	6	8006043 017212

Confezione: etichetta e gancio / Packaging: label and plastic hook

Stampo quadro

Square cake tin
Moule carré
Quadratische Backform
Molde cuadrado



CODE	CM	H CM	PACK	EAN
54524HGNAM	24 x 24	4,5	6	8006043 017229

Confezione: etichetta e gancio / Packaging: label and plastic hook

Teglia rettangolare ◀estensibile▶

Adjustable baking tray - Plaque à four rectangulaire extensible
Ausziehbare Backform - Bandeja rectangular extensible



CODE	CM	H CM	PACK	EAN
53634HEE	33,3 x 38	3	6	8006043 017236
	33,3 x 51,3			

Confezione: etichetta / Packaging: label



MULTIUSO - MULTIPURPOSE

Teglia da forno piatta

Cookie sheet - Plaque à biscuits
Backblech flach - Bandeja para galletas

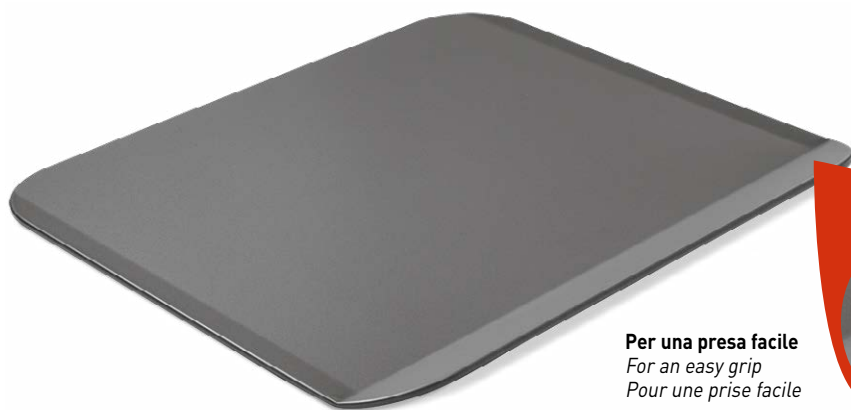

Per una presa facile
For an easy grip
Pour une prise facile

CODE	CM	H CM	PACK	EAN
53735HGNAM	35 x 40	0,2	6	8006043 017243

Confezione: etichetta e gancio / Packaging: label and plastic hook



MULTIUSO - MULTIPURPOSE





Guardini



Temperatura
Temperature
Température



Antiaderenza
Non-stick
Antiadhérence



Strati antiaderente
Non-stick layers
Couches antiadhésives



Resistenza ai graffi
Scratch resistance
Résistance aux rayures



Garanzia
Warranty
Garantie





Bake Away



Bake Away è una linea di stampi da forno corredati di un coperchio con pratiche maniglie, ideale per trasportare ovunque tutte le preparazioni cotte o da cuocere.

Gli stampi sono realizzati in acciaio Hi-Top con rivestimento antiaderente doppio strato, e garantisce risultati perfetti di cottura e di antiaderenza. La particolare conducibilità termica dell'acciaio utilizzato garantisce cotture in forno rapide ed uniformi di piatti dolci e salati. Il coperchio è realizzato in plastica e consente la chiusura dello stampo. È inoltre dotato di resistenti manici che ne permettono una facile impugnabilità. **Il coperchio è da utilizzarsi solo per la conservazione delle pietanze in frigorifero e per il trasporto.**

Bake Away is a range of moulds equipped with a convenient carrying lid, which allows you to carry anywhere all your preparations, cooked or to be cooked.

The moulds are made of Hi-Top steel with a double layer of non-stick coating, that ensures excellent cooking results and easy food release. The excellent heat distribution of the steel allows a quick and uniform cooking of sweet and savoury recipes. The lid is made of plastic and clings steadily to the mould, while the solid handles give a firm grip. **The lid should be used only for storing food in the refrigerator and for transportation.**

VISTA FRONTE - FRONT VIEW



COPERCHIO - LID



Pratiche maniglie per il trasporto.
Practical handles for transport.



MADE in ITALY

Tortiera apribile 1 fondo con coperchio per trasporto

Springform 1 base with carrying lid
Moule démontable 1 fond
avec couvercle de transport
Springform mit Transporthaube
Molde desmontable 1 fondo
con tapa transportable



CODE	CM	H CM	PACK	EAN
55126BAK	ø 26	7,6	4	8006043 003468

*Dim. tortiera con coperchio - Size springform with lid: ø 27,8 x H 10,5 cm

Confezione: etichetta adesiva / Packaging: sticker

 **Speciale fondo salvagoccia**
Leakproof base

Stampo crostata con coperchio per trasporto

Flan tin with carrying lid
Moule à tarte avec couvercle
de transport
Obsttortenboden mit
Transporthaube
Molde rizado con tapa
transportable



CODE	CM	H CM	PACK	EAN
56028FPBAK1	ø 28	4	4	8006043 000542

*Dim. crostata con coperchio - Size flan tin with lid: ø 30,7 x H 6,4 cm

Confezione: etichetta adesiva / Packaging: sticker

Stampo da forno con coperchio per trasporto

Baking mould with carrying lid
Plat à four avec couvercle
de transport
Brat-und Backform mit
Transporthaube
Molde de horno con tapa
transportable



CODE	CM	H CM	PACK	EAN
59024BAK	24 x 32	4,7	4	8006043 003161

*Dim. lasagnera con coperchio - Size mould with lid: 27,6 x 37,2 x H 8,5 cm

Confezione: etichetta adesiva / Packaging: sticker

Stampo 12 muffins con coperchio per trasporto

12 Muffins tray with
carrying lid
Plat à 12 Muffins avec
couvercle de transport
12 Muffinform mit
Transporthaube
Molde muffin 12 pzas
con tapa transportable



CODE	CM	H CM	PACK	EAN
59912BAK	27 x 35,5	3	4	8006043 000566

*Dim. stampo con coperchio - Size mould with lid: 27,2 x 36,4 x H 7,8 cm

Confezione: etichetta adesiva / Packaging: sticker





Guardini®



Temperatura
Temperature
Température



Antiaderenza
Non-stick
Antiadhérence



Strati antiaderente
Non-stick layers
Couches antiadhésives



Resistenza ai graffi
Scratch resistance
Résistance aux rayures



Garanzia
Warranty
Garantie





pizza & mania



Una gamma specifica per la cottura in forno della pizza, in diversi formati. Linea Pizza&Mania, per sfornare e servire senza difficoltà tutto il gusto della tradizione italiana.

Realizzata in acciaio Hi-Top con rivestimento antiaderente doppio strato, la linea garantisce la cottura perfetta e la facile sformatura di pizze di tutti i generi.

A special range for cooking pizzas, in different shapes. With Pizza&Mania, all the pleasure and taste of Italian tradition can now be served up directly from the oven.

Made of Hi-Top steel with a double layer of non-stick coating, this line ensures perfect results and easy food release.



MADE in ITALY

Tegame pizza

Pizza tin
Plaque à pizza
Pizzaform
Molde para pizza



CODE	CM	H CM	PACK	EAN
27528	ø 28	1,5	24	8006043 275285
27532	ø 32	1,5	24	8006043 275322

Confezione: etichetta / Packaging: label

Tegame pizza surgelata

Frozen pizza tin
Plaque à pizza surgelée
Pizzaform
Molde para pizza congelada



CODE	CM	H CM	PACK	EAN
27732EX	ø 32	1,5	12	8006043 277326

Confezione: etichetta / Packaging: label

Teglia rettangolare

Baking sheet
Plaque à four rectangulaire
Herbbackblech
Bandeja rectangular



CODE	CM	H CM	PACK	EAN
28526	26 x 37	2,1	24	8006043 285260
28532	32 x 37	2,1	24	8006043 285321

Confezione: etichetta / Packaging: label

ø 32

Set 10 pezzi pizza

Gift box (10 pcs set)
Boîte cadeau (lot de 10 pièces)
Geschenkpaket (10 Stück)
Caja regalo (10 piezas)



CODE	CM	PACK	EAN
27514RK	34 x 34 x 8	4	8006043 275148

Confezione: scatola / Packaging: box
Per maggiori dettagli: vedi pag. 165 / For more details: see page 165

ø 28

I love pizza - 5 pezzi

Set 4 tegami pizza + supporto in acciaio
Set 4 pizza tins with steel grill rack
Lot 4 moules à pizza avec support en acier
4 Pizzaform+pizzabäcker-set
Set 4 bandejas pizza + soporte en acero



CODE	CM	PACK	EAN
27516RK	31 x 31 x 5	4	8006043 013818

Confezione: scatola / Packaging: box
Per maggiori dettagli: vedi pag. 165 / For more details: see page 165

Griglia porta pizze

Steel grill rack for pizza tins
Support en acier
pour moules à pizza
Pizzabäcker-set
Soporte porta pizzas

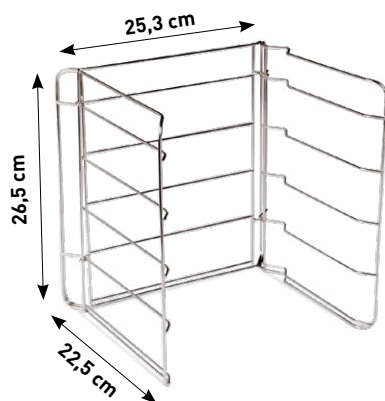

CODE	CM	H CM	PACK	EAN
15608E	25,3 x 22,5	26,5	12	8006043 156089

Adatta per tegami pizza da ø 28 cm e ø 32 cm
Suitable for pizza tin ø 28 cm and ø 32 cm

Confezione: fascia in cartoncino appendibile
Packaging: with hangable carton label

Set 3 tegami pizza + griglia porta pizze

Set 3 pizza tins with steel grill rack
Lot 3 moules à pizza avec support en acier
3 Pizzaform+pizzabäcker-set
Set 3 bandejas pizza + soporte en acero



CODE	CM	H CM	PACK	EAN
27526RK	30 x 30	26,5	6	8006043 014594

Dimensione della griglia con tegami pizza inseriti
Sizes of opened grill rack with pizza tins

Confezione: film + etichetta / Packaging: film + label

Set 4 tegami pizza + griglia porta pizze

Set 4 pizza tins with steel grill rack
Lot 4 moules à pizza avec support en acier
4 Pizzaform+pizzabäcker-set
Set 4 bandejas pizza + soporte en acero



CODE	CM	H CM	PACK	EAN
27535RK	34 x 34	26,5	6	8006043 014600

Dimensione della griglia con tegami pizza inseriti
Sizes of opened grill rack with pizza tins

Confezione: film + etichetta / Packaging: film + label

Mini display Pizza

Cubic mini box
Mini présentoir cubique
Kubisch Mini Box
Mini expositor cubico



CM	H CM
40 x 40	76

Crostata di pere e crema alle mandorle

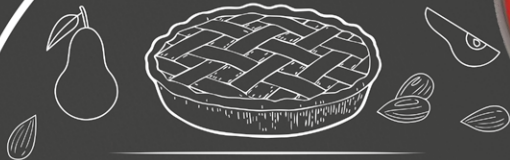

INGREDIENTI PER 10 PERSONE

1 rotolo di pasta frolla già pronta, 100 g di burro, 100 g di zucchero, 100 g di farina di mandorle, 2 uova, 400 g di pere sciroppate, lamelle di mandorle.

PROCEDIMENTO

Posizionare la pasta frolla nello stampo crostata. Poi con una forchettina bucherellare la base. Lavorare il burro ammorbidito in precedenza con lo zucchero. Poi aggiungere le uova e mescolare per bene. Infine incorporare la farina di mandorle e mescolare nuovamente. Versare nello stampo la crema di mandorle ottenuta e livellarla con una spatola. Tagliare a fettine sottili le pere nel senso della larghezza cercando di mantenere integra la forma del frutto.

Poi adagiarle sulla crema di mandorle. Spolverare la superficie con le lamelle di mandorle. Informare per 30 minuti a 180°C. La golosa crostata è pronta!

WE WISH YOU A
Merry
CHRISTMAS
AND HAPPY
★ **NEW YEAR!**



Guardini

Guardini

TAMPOGRAFIA - PAD PRINTING

ALCUNE DELLE NOSTRE PRODUZIONI - SOME OF OUR PRODUCTIONS



ESEMPIO TAMPOGRAFIA INTERNA
EXAMPLE INTERNAL PAD PRINTING



Una tecnologia di stampa che dà la possibilità di stampare in **alta qualità** elementi grafici sugli stampi da forno. Questa tecnologia permette di stampare **fino a 6 colori** (quadricromia + 2 colori pantone) resistenti alle alte temperature e al lavaggio.

Nuove e infinite possibilità di espressione grafica sono ora realizzabili, ideali per attività di **licensing** e **progetti personalizzati** per specifiche esigenze. La stampa tampografica è **realizzata e gestita internamente**, garantendo così flessibilità e una risposta rapida a tutte le specifiche richieste.

È anche possibile realizzare la tampografia all'**interno dello stampo**, utilizzando esclusivamente **inchiostri alimentari** testati per un utilizzo in forno fino a 230°C (tampografia interna realizzabile a 1 colore, bianco).

A technology which permits to print **HD quality** photos and graphics on our bakeware moulds. Thanks to this technology it is possible to print with **4 colour process + 2 pantone colours** decorations resistant to oven temperature and washing.

It is then a **new promotional possibility**, particularly suitable for licensing and customized project. The decoration process is **entirely arranged in our factory**, granting flexibility and fast response to customers' needs.

It is also possible to carry out the pad printing **inside the mould**, using exclusively **food inks** tested for use in the oven up to 230°C (internal pad printing available in 1 colour, white).



ESEMPIO TAMPOGRAFIA ESTERNA
EXAMPLE EXTERNAL PAD PRINTING







Guardini®

NEW

92-99

ALLUMINIO
ANODIZZATO
ANODIZED
ALUMINIUM

STAMPI IN ALLUMINIO ANODIZZATO
ANODIZED ALUMINIUM MOULDS

94 Professional

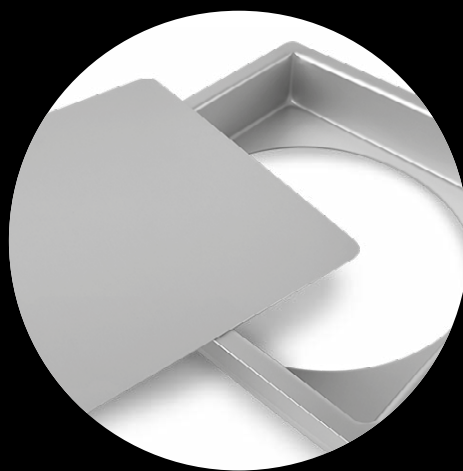

- Adatto per un uso professionale
- Risparmio di tempo
- Peso leggero
- Ultra durevole
- Temperatura massima di utilizzo: 285°C

- *Suitable for professional use*
- *Saving of time*
- *Light weight*
- *Ultra durable*
- *Temperature maximum: 285°C*



Guardini



RISPARMIO TEMPO
SAVE TIME
GAGNER DU TEMPS



PESO LEGGERO
LIGHT WEIGHT
POIDS LÉGER



ULTRA DUREVOLE
ULTRA DURABLE
ULTRA DURABLE

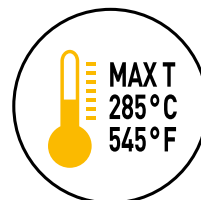



Guardini
professional

NEW

ANODIZED ALUMINIUM

PROFESSIONALE COME UNO CHEF | PROFESSIONAL AS A CHEF | PROFESSIONNEL COMME UN CHEF



La nuova collezione Guardini Professional è una linea elegante ad alte prestazioni professionali, con il suo colore argento. Questa linea utilizza un nuovo materiale, l'alluminio anodizzato, che permette di preparare dolci e salati come un vero Chef!

Questa eleganza si combina con prestazioni di alta qualità e un packaging altrettanto elegante e di classe. Questo materiale permette anche una facile pulizia dopo l'uso. Grazie alla sua elevata resistenza all'abrasione, è consigliato per un uso intensivo e di alto livello. Alcuni stampi hanno il fondo smontabile, per una ottima sfornabilità e presentazione. Temperatura massima di utilizzo: 285°C.

The new Guardini Professional collection is an elegant line with high professional performance, in silver colour.

This range is made of a new material, anodized aluminium, which allows you to prepare sweet and savory dishes like a real Chef!

This elegance is combined with high-quality performance and equally elegant and stylish packaging. This material also allows easy cleaning after use. Thanks to its high abrasion resistance, it is recommended for intensive and high-level use. Some moulds have a removable bottom, for an easy release and presentation. Maximum temperature of use: 285°C.

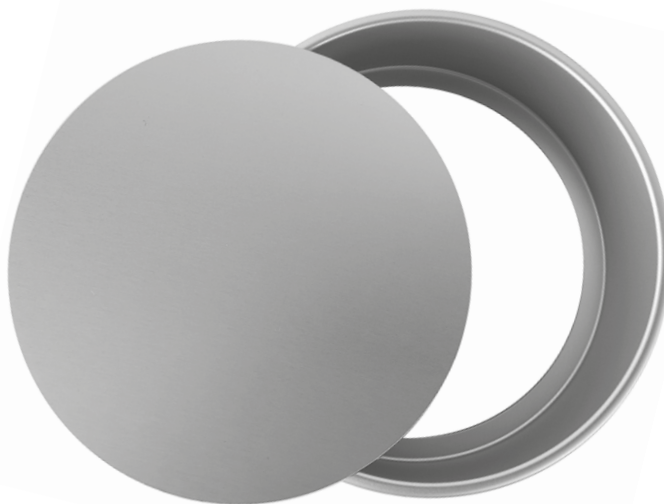

Tortiera apribile 1 fondo

Springform 1 base
Moule démontable 1 fond
Springform
Molde desmontable 1 fondo

CODE	CM	H CM	PACK	EAN
MY2917A	ø 20	7,5	6	8006043 022896
MY2918A	ø 23	7,5	6	8006043 022902

Confezione: etichetta / Packaging: label



Speciale fondo salvagoccia
Leakproof base



Tortiera liscia con fondo smontabile

Round cake tin with removable bottom
Moule à clafoutis avec fond amovible
Runde backform mit abnehmbarem Boden
Molde alto con base desmontable

CODE	CM	H CM	PACK	EAN
MY2148A	ø 20	7,5	6	8006043 022926
MY2150A	ø 26	7,5	6	8006043 022933

Confezione: etichetta / Packaging: label



Speciale fondo smontabile
Loose base

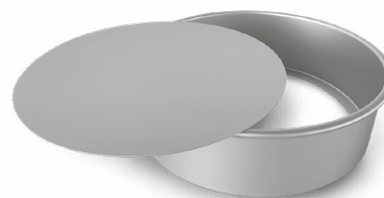

Chiffon cake con fondo smontabile

Chiffon cake with removable bottom
Chiffon cake avec fond amovible
Chiffon Kuchenform mit abnehmbarem Boden
Chiffon Cake con base desmontable

CODE	CM	H CM	PACK	EAN
MY2928A	ø 21	9,5	6	8006043 022919

Confezione: etichetta / Packaging: label



Speciale fondo smontabile
Loose base



Stampo crostata con fondo smontabile

Flan tin with removable bottom
Moule à tarte avec fond amovible
Tarteform mit abnehmbarem Boden
Molde rizado con base desmontable

CODE	CM	H CM	PACK	EAN
MY6430A	ø 25	2,5	6	8006043 022940

Confezione: etichetta / Packaging: label



Speciale fondo smontabile
Loose base

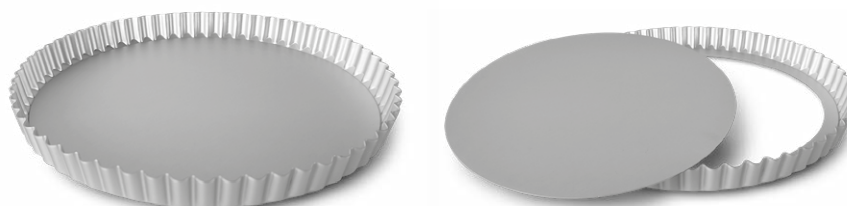

Lasagnera con fondo smontabile

Bake & roast pan with removable bottom
Plat à four avec fond amovible
Auflaufform mit abnehmbarem Boden
Rustidera con base desmontable

CODE	CM	H CM	PACK	EAN
MY2527A	18 x 28	5	6	8006043 022957

Confezione: etichetta / Packaging: label



Speciale fondo smontabile
Loose base



Stampo quadro con fondo smontabile

Square cake tin with removable bottom
Moule carré avec fond amovible
Quadratische Backform mit abnehmbarem Boden
Molde cuadrado con base desmontable

CODE	CM	H CM	PACK	EAN
MY2330A	26 x 26	5	6	8006043 022964

Confezione: etichetta / Packaging: label



Speciale fondo smontabile
Loose base



Stampo plumcake

Loaf tin
Moule à cake
Königskuchenform
Molde plumcake

CODE	CM	H CM	PACK	EAN
MY2942A	30 x 11	10	6	8006043 022971

Confezione: etichetta / Packaging: label



Teglia rettangolare

Baking sheet
Plaque à four rectangulaire
Herbackblech
Bandeja rectangular

CODE	CM	H CM	PACK	EAN
MY1721A	28 x 41	2,5	6	8006043 022988

Confezione: etichetta / Packaging: label



Lasagnera

Bake & roast pan
Plat à four
Auflaufform
Rustidera

CODE	CM	H CM	PACK	EAN
MY2450A	23 x 33	7,5	6	8006043 022995

Confezione: etichetta / Packaging: label









Guardini

100-107

ALLUMINIO PRESSOFUSO CAST ALUMINIUM

STAMPI IN ALLUMINIO PRESSOFUSO
CAST ALUMINIUM MOULDS

- 102 Sweet Magic
- 104 Lily Flower
- 104 Classic
- 105 Marquise
- 105 Cascade
- 106 Belle
- 106 Marissa
- 107 Espositore / Display



USO PROFESSIONALE E CASALINGO
PROFESSIONAL USE AND HOME BAKING
USAGE PROFESSIONNEL ET MAISON

Testati e consigliati dai Pastry Chefs della I.F.S.E., la più innovativa scuola di Alta Cucina e Pasticceria d'Italia.

Tested and recommended by the I.F.S.E. Pastry Chefs, the most innovative Italian school of haute cuisine and pastry.

Testés et recommandés par les Pâtisseries de I.F.S.E., la plus innovante école italienne de haute cuisine et de pâtisserie.





Guardini®



Temperatura
Temperature
Température



Antiaderenza
Non-stick
Antiadhérence



Strati antiaderente
Non-stick layers
Couches antiadhésives



Resistenza ai graffi
Scratch resistance
Résistance aux rayures



Garanzia
Warranty
Garantie

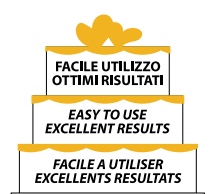



Sweet Magic



La gamma **Sweet Magic** è una linea di stampi da forno realizzata in **alluminio pressofuso**, per la realizzazione di torte creative.

Le forme eleganti permettono di realizzare in modo **casalingo** o **professionale** torte creative, dal **risultato assicurato**.

Tale eleganza è combinata con prestazioni antiaderenti di **alta qualità** e **resistenza ai graffi e all'usura**, grazie ai **2 strati di antiaderente**.

La gamma si presenta con un **pack elegante**, descrittivo, completo di tutte le informazioni per una vendita di successo.

The **Sweet Magic** range is composed by oven moulds made of **cast aluminum**, for the realization of creative cakes.

The elegant shapes allow you to make **homemade** or **professional** cakes, with **guaranteed results**.

This elegance is combined with a **high-quality non-stick performance** and a resistance to scratches and use, thanks to the **2 layers of non-stick coating**.

The range has an elegant, descriptive **pack**, complete with all the information for a successful sale.



Stampi da forno per torte creative

Baking moulds for creative cakes - Moules pour gâteaux créatifs - Backformen für kreative Kuchen - Moldes para pasteles creativos



CODE	CM	H CM	PACK	EAN
LV-104	ø 23,5	10	4	8006043 014969

Confezione: scatola / Packaging: box



★ **Lily Flower** ★



CODE	CM	H CM	PACK	EAN
LV-105	ø 23,5	10	4	8006043 014976

Confezione: scatola / Packaging: box



★ **Classic** ★



Stampi da forno per torte creative

Baking moulds for creative cakes - Moules pour gâteaux créatifs - Backformen für kreative Kuchen - Moldes para pasteles creativos



CODE	CM	H CM	PACK	EAN
LV-111	ø 24,5	10	4	8006043 014983

Confezione: scatola / Packaging: box



★ **Marquise** ★



CODE	CM	H CM	PACK	EAN
LV-115	ø 24	11	4	8006043 014990

Confezione: scatola / Packaging: box



★ **Cascade** ★



Stampi da forno per torte creative

Baking moulds for creative cakes - Moules pour gâteaux créatifs - Backformen für kreative Kuchen - Moldes para pasteles creativos



CODE	CM	H CM	PACK	EAN
LV-126	ø 24,5	9,5	4	8006043 015003

Confezione: scatola / Packaging: box



★ Belle ★



CODE	CM	H CM	PACK	EAN
LV-186	ø 24	9	4	8006043 015010

Confezione: scatola / Packaging: box



★ Marissa ★



Espositore

Display
Présentoir
Display
Expositor

CODE	PACK
90134	1



*L'espositore da banco è adatto a tutte le forme della linea Sweet Magic.
The counter display is suitable for all moulds of the Sweet Magic line.*



ADATTO A DIVERSE TIPOLOGIE DI IMPASTO

- Impasto montato al burro;
- impasto liquido;
- impasto lievitato;
- impasto morbido.

SUITABLE FOR DIFFERENT TYPES OF DOUGH

- Dough mounted with butter;
- liquid mixture;
- leavened mixture;
- soft dough.

APPROPRIÉ À DIFFÉRENTS TYPES DE PÂTE

- Pâte montée au beurre ;
- mélange liquide ;
- pâte levée ;
- pâte molle.



OTTIMA ANTIADERENZA

Antiaderente eccellente che garantisce ottimi risultati con il minimo sforzo. Ungere sempre l'interno dello stampo con un velo uniforme di olio, burro o margarina in modo che le insenature risultino perfette.

EXCELLENT NON-STICK

Excellent non-stick that guarantees excellent results with minimum effort. Always grease the inside of the mould with a uniform veil of oil, butter or margarine so that the inlets will be perfect.

EXCELLENT ANTIADHESIF

Excellent antiadhésif qui garantit d'excellents résultats avec un minimum d'effort. Toujours graisser l'intérieur du moule avec un voile uniforme d'huile, de beurre ou de margarine afin que les profondeurs soient parfaites.



TIPOLOGIA DI COTTURA

- Adatto al forno statico;
- adatto al forno ventilato;
- adatto al forno a gas.

BAKING TYPE

- Suitable for static oven;
- suitable for ventilated oven;
- suitable for the gas oven.

TYPE DE CUISSON

- Approprié pour four statique ;
- approprié pour four ventilé ;
- approprié pour le four à gaz.



OTTIMA SFORMABILITÀ

L'ottima antiaderenza garantisce una sfornabilità eccellente per presentazioni ad effetto.

EXCELLENT DEMOULDING

The excellent non-stick guarantees excellent demoulding for effective presentations.

EXCELLENT DEMOULAGE

L'excellent antiadhésif garantit un excellent démoulage pour des présentations efficaces.





Guardini®

108-113

BANDA STAGNATA *TINPLATE*

STAMPI IN BANDA STAGNATA
TINPLATE MOULDS

110 Selenia



- Economico
- Adatto per la cottura in forni tradizionali (no microonde)
- Ideale per la cottura di tutti i tipi di dolce
- Facile pulizia dopo l'uso

- *Inexpensive*
- *Suitable for cooking in traditional ovens (no microwave)*
- *Ideal for baking all kinds of cakes*
- *Easy cleaning after use*



Guardini



Temperatura
Temperature
Température



Resistenza ai graffi
Scratch resistance
Résistance aux rayures



Garanzia
Warranty
Garantie





Selenia



Pratici e convenienti, gli stampi da forno della linea Selenia in banda stagnata propongono le forme più amate e richieste dai consumatori. La banda stagnata elettroliticamente è un tipo di acciaio economico, adatta al contatto con gli alimenti, ideale per la cottura in forno di tutti i tipi di dolce.

Practical and with an affordable price, the Selenia collection of tinplate bakeware includes the most popular shapes on the market. Selenia is made of electrolytic tin-plated material, which is very convenient for cooking any dessert.



MADE in ITALY

**Tortiera apribile
2 fondi**

Springform 2 bases
Moule démontable 2 fonds
Springform+Rohrboden
Molde desmontable 2 fondos



CODE	CM	H CM	PACK	EAN
45224	ø 24	6,9	6	8006043 452242
45226	ø 26	6,9	6	8006043 452266
45228	ø 28	6,9	6	8006043 452280

Confezione: etichetta / Packaging: label

**Tortiera apribile
1 fondo**

Springform 1 base
Moule démontable 1 fond
Springform
Molde desmontable 1 fondo



CODE	CM	H CM	PACK	EAN
45024	ø 24	6,8	6	8006043 450248
45026	ø 26	6,8	6	8006043 450262
45028	ø 28	6,8	6	8006043 450286
45030	ø 30	6,8	6	8006043 450309

Confezione: etichetta / Packaging: label

Stampo crostata

Flan tin
Moule à tarte
Obsttortenboden
Molde rizado



CODE	CM	H CM	PACK	EAN
46028FP	ø 28	4	24	8006043 460285

Confezione: etichetta / Packaging: label

Stampo plumcake

Loaf tin
Moule à cake
Königskuchenform
Molde plumcake



CODE	CM	H CM	PACK	EAN
48025	25 x 12	7,9	24	8006043 480252
48030	30 x 12	7,9	24	8006043 480306

Confezione: etichetta / Packaging: label







Guardini®

NEW

114-119

VETRO BOROSILICATO *BOROSILICATE GLASS*

STAMPI IN VETRO BOROSILICATO
BOROSILICATE GLASS MOULDS

116 Vetro borosilicato / *Borosilicate glass*



- Resiste a temperature estreme, da -40°C a $+300^{\circ}\text{C}$
- Resistente agli shock termici fino a 200°C
- Può essere utilizzato in forno, nel microonde, nella lavastoviglie, nel frigo e nel freezer
- Materiale sano, privo di BPA e igienico, non trattiene macchie o odori
- Resistente ai graffi
- Materiale riciclabile al 100%

- *Resists to extreme temperatures, from -40°C to $+300^{\circ}\text{C}$*
- *Resists thermal shock up to 200°C*
- *Can be used in oven, microwave, dishwasher, fridge and freezer*
- *Healthy, BPA-free and hygienic material, does not retain stains or odors*
- *Resistant to scratches and wear*
- *100% recyclable material*





Guardini

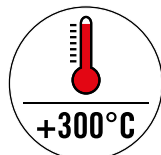



VETRO BOROSILICATO

NEW



Le teglie in vetro Guardini sono realizzate in vetro borosilicato, garantiscono una cottura sana e sicura. Sono inoltre resistenti agli shock termici e ai graffi.

Le nostre teglie in vetro sono ideali per cucinare, preparare, riscaldare e congelare i vostri piatti in modo facile e sicuro, oltre che presentare i piatti direttamente a tavola. I vantaggi del vetro borosilicato sono molteplici: resiste a temperature estreme, da **-40°C a +300°C**; resiste agli **shock termici fino a 200°C**; può essere utilizzato in **forno**, nel **microonde**, nella **lavastoviglie**, nel **frigo** e nel **freezer**; è un **materiale sano, privo di BPA e igienico**, non trattiene macchie o odori; è **resistente ai graffi e all'usura**. Il materiale è **riciclabile al 100%**.

Guardini glass pans are made of borosilicate glass, a material that ensures a healthy and safe cooking. They are also resistant to thermal shock and scratches.

*Our glass pans are ideal for cooking, preparing, heating and freezing dishes easily and safely, as well as presenting the dishes directly to the table. The advantages of borosilicate glass are many: it resists to extreme temperatures, from **-40°C to +300°C**; it resists to thermal shocks up to **200°C**; it can be used in **oven, microwave, dishwasher, fridge and freezer**; it is a **healthy, BPA-free, hygienic material** and it does not retain stains or odors; it is also **resistant to scratches and wear**. The material is **100% recyclable**.*



Ciotola

Bowl
Bol
Rührschüssel
Bol



CODE	CM	LT	PACK	EAN
YL-YMC1100	ø 17	1,1	6	8006043 023206
YL-YMC2100	ø 21	2,1	6	8006043 023190
YL-YMC2600	ø 23	2,6	6	8006043 023183

Confezione: etichetta / Packaging: label

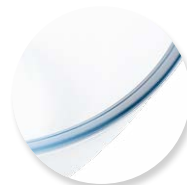

Teglia rotonda con manici

Round Casserole dish
with handles
Cocotte Ronde
Auflaufform mit Griffen
Cacerola redonda con asas



CODE	CM	LT	PACK	EAN
SLY-YBER1600	ø 21	1,6	6	8006043 023220

Confezione: etichetta / Packaging: label



Stampo crostata

Pie pan
Moule à tarte
Tarteform
Molde para Tarta



CODE	CM	LT	PACK	EAN
SLY-YPLT27	ø 27	1,6	6	8006043 023237

Confezione: etichetta / Packaging: label



Stampo plumcake

Loaf pan
Moule à cake
Königskuchenform
Molde plumcake



CODE	CM	LT	PACK	EAN
YL-TYBR1800	27 x 14	1,8	6	8006043 023275

Confezione: etichetta / Packaging: label



Teglia rettangolare con manici

Baking dish
Plat à four rectangulaire
Auflaufform mit Griffen
Fuente de forma rectangular con asas



CODE	CM	LT	PACK	EAN
SLY-YBR20	30 x 20	2	6	8006043 023244
SLY-YBR27	34 x 22,5	2,7	6	8006043 023251
SLY-YBR38	38 x 25,5	3,8	6	8006043 023268

Confezione: etichetta / Packaging: label

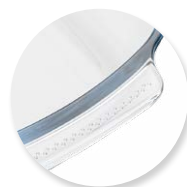

Teglia ovale

Oval baking dish
Plat à four ovale
Auflaufform Oval
Plato oval



CODE	CM	LT	PACK	EAN
SLY-YBD024	30 x 21,5	2,4	6	8006043 023282
SLY-YBD030	35 x 24	3	6	8006043 023299

Confezione: etichetta / Packaging: label

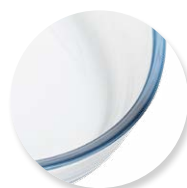

Bicchiere misuratore

Measuring cup
Verre mesureur
Messbecher
Vaso medidor

0,5 LT



CODE	CM	LT	PACK	EAN
SLY-YGP500	ø7 x H13,8	0,5	6	8006043 023213

Confezione: etichetta / Packaging: label







Guardini®

120-133

CARTA &
PLASTICA
*PAPER &
PLASTIC*

COLLEZIONI CARTA & PLASTICA
PAPER & PLASTIC COLLECTIONS

122 Easy Bake Bio **NEW**

126 Easy Bake



- Ideali per presentare i dolci in tavola
- 100% Made in Italy

- *Ideal for presenting desserts on the table*
- *100% Made in Italy*



Guardini

GUARDINI PER L'AMBIENTE

SACCHETTO: PP5 RACCOLTA PLASTICA

100% RICICLATO E RICICLABILE

PRODOTTI

100% RICICLABILE RECYCLABLE

100% COMPOSTABILE COMPOSTABLE

MADE IN ITALY



Abbiamo a cuore il pianeta scopri perché
 We care about the planet find out why
 Nous avons à cœur la planète découvrez pourquoi



EASY Bake^{Bio}

NEW

**4ACTIONS
 4MORE**
 SUSTAINABLE IMPACT



Easy Bake Bio è la nuova collezione di stampi monouso per la cottura in forno di preparazioni dolci e salate, di vassoi per la presentazione di dolcetti e salatini, di pirottini per la preparazione dei muffins e cupcakes. Il pack è realizzato in **plastica totalmente riciclata**. Gli stampi sono **100% Made in Italy**.

Easy Bake Bio is the new collection of disposable moulds for baking sweet and savory dishes. The range is made of trays for the presentation of pastries and other food and cups for the preparation of muffins and cupcakes. The pack is made of **recycled plastic**. The moulds are **100% Made in Italy**.

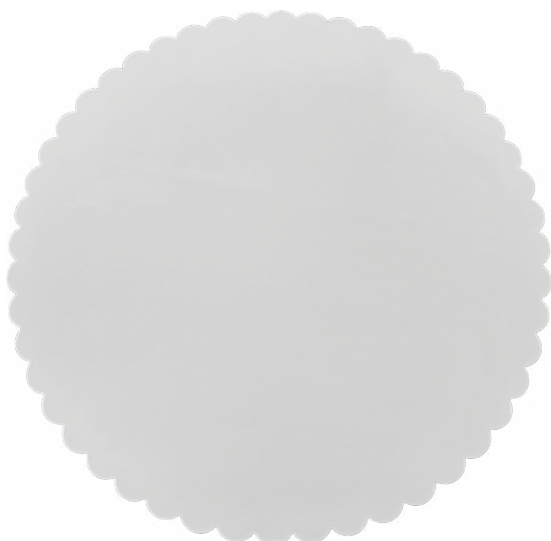

MADE in ITALY

Pirottini carta da forno

Paper cupcakes
Barquettes en papier
Papier-backförmchen
Moldes papel



CODE	CM	H CM	PZ	PACK	EAN
15751BIO	ø 4,5	2,3	100	12	8006043 023046
15749BIO	ø 7	3	100	12	8006043 023039

Confezione: sacchetto trasparente / Packaging: transparent bag

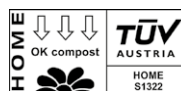

Pirottini tulipano carta da forno

Tulip paper cupcakes
Cupcakes tulip en papier
Papier-backförmchen tulip
Moldes papel tulip



CODE	CM	H CM	PZ	PACK	EAN
15831BIO	ø 5	8,5	12	12	8006043 023053

Confezione: sacchetto trasparente / Packaging: transparent bag

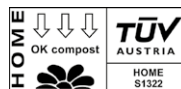

Stampo tondo alto carta da forno

High round mould
Moule rond haut
Runde Papier-Backform
Molde redondo alto



CODE	CM	H CM	PZ	PACK	EAN
15835BIO	ø 19	6,2	3	12	8006043 023060

Confezione: sacchetto trasparente / Packaging: transparent bag

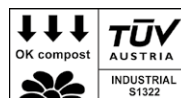

Stampo crostatina carta da forno

Pie baking mould
Tartelette en papier
Tortelett in Papier
Molde tartaleta



CODE	CM	H CM	PZ	PACK	EAN
15755BIO	ø 9	2,3	6	12	8006043 023077

Confezione: sacchetto trasparente / Packaging: transparent bag



Stampo plumcake carta da forno

Loaf pan
Moule à cake
Königskuchenform
Molde bizcocho



CODE	CM	H CM	PZ	PACK	EAN
15758BIO	16,5	5,5	3	12	8006043 023084
15759BIO	23	7	3	12	8006043 023091

Confezione: sacchetto trasparente / Packaging: transparent bag



Stampo crostata carta da forno

Flan paper tin
Moule à tarte en papier
Obsttortenboden in Papier
Molde rizado papel



CODE	CM	H CM	PZ	PACK	EAN
15763BIO	ø 25	3	2	12	8006043 023107

Confezione: sacchetto trasparente / Packaging: transparent bag



Vassoio bianco cartoncino

White paper tray
Plateau carton couleur
blanc
Weissenen Papierfach
Bandeja de papel blanco



CODE	CM	PZ	PACK	EAN
15792BIO	18 x 26	3	12	8006043 023138
15745BIO	22 x 32	3	12	8006043 023121
15793BIO	28 x 38	2	12	8006043 023145
15742BIO	31 x 42	2	12	8006043 023114

Confezione: sacchetto trasparente / Packaging: transparent bag



Vassoio bianco cartoncino

White paper tray
Plateau carton couleur
blanc
Weissenen Papierfach
Bandeja de papel blanco



CODE	CM	PZ	PACK	EAN
15794BIO	ø 23	3	12	8006043 023176
15743BIO	ø 31	3	12	8006043 023152
15744BIO	ø 34	2	12	8006043 023169

Confezione: sacchetto trasparente / Packaging: transparent bag



Sotto torta bianco cartoncino

White cake board
Sous-gâteau couleur blanc
Weiße Tortenuntersätze
Sub pastel blanco

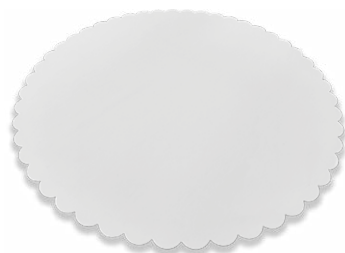

CODE	CM	PZ	PACK	EAN
15765BIO	ø 32	2	12	8006043 023329

Confezione: sacchetto trasparente / Packaging: transparent bag





Guardini





EASY Bake



Easy Bake è una collezione che si compone di stampi in carta e plastica per la cottura in forno di preparazioni dolci e salate, di vassoi per la presentazione di dolcetti e salatini, di pirottini per la preparazione di muffin e cupcake, di pizzi e portatorte per il trasporto fuori casa. Pratici e convenienti, i prodotti della linea Easy Bake sono realizzati utilizzando differenti materiali, tutti adatti al contatto alimentare, nel rispetto dell'ambiente e delle normative vigenti. I prodotti della collezione Easy Bake sono rigorosamente **MADE IN ITALY**.

Easy Bake is a collection composed by paper and plastic moulds and serving trays for sweets and savouries, paper cupcakes ideal for baking muffins and cupcakes, doilies and cake boxes. Practical and affordable, Easy Bake products are made using different materials, all suitable for food contact, respecting the environment and regulations. Easy Bake is an entirely **MADE IN ITALY** collection.



MADE in ITALY

STAMPI COTTURA TONDI E RETTANGOLARI - ROUND AND RECTANGULAR BAKING MOULDS

**Stampo
crostatina**

*Pie baking mould
Tartelette en papier
Tortelett in Papier
Molde tartaleta*



CODE	CM	H CM	PZ	PACK	EAN
15754	ø 10	3	6	12	8006043 008630

Confezione: sacchetto trasparente / Packaging: transparent bag

**Stampo
crostatina**

*Pie baking mould
Tartelette en papier
Tortelett in Papier
Molde tartaleta*



CODE	CM	H CM	PZ	PACK	EAN
15755	ø 9	2,3	6	12	8006043 008647

Confezione: sacchetto trasparente / Packaging: transparent bag

**Stampo
brownies**

*Brownies baking mould
Moule à brownies
Brownies backform
Molde brownies*



CODE	CM	H CM	PZ	PACK	EAN
15756	16 x 16	2,5	3	12	8006043 008654

Confezione: sacchetto trasparente / Packaging: transparent bag

**Stampo
mini-plumcake**

*Mini-loaf pan
Mini cake
Mini Kuchen
Mini bizcocho*



CODE	CM	H CM	PZ	PACK	EAN
15757	8 x 4	4	6	12	8006043 008661

Confezione: sacchetto trasparente / Packaging: transparent bag

**Stampo
plumcake**

*Loaf pan
Moule à cake
Königskuchenform
Molde bizcocho*



CODE	CM	H CM	PZ	PACK	EAN
15759	23 x 7	7	3	12	8006043 008685

Confezione: sacchetto trasparente / Packaging: transparent bag

**Stampo
torta**

*Round baking mould
Moule à clafoutis
Kuchenform
Molde alto*



CODE	CM	H CM	PZ	PACK	EAN
15760	ø 21	3	3	12	8006043 008692

Confezione: sacchetto trasparente / Packaging: transparent bag

Stampo ciambella

Savarin paper mould
Moule à savarin
Kranzform
Molde savarin



CODE	CM	H CM	PZ	PACK	EAN
15762	ø 20	7	3	12	8006043 008715

Confezione: sacchetto trasparente / Packaging: transparent bag

Stampo crostata

Flan tin
Moule à tarte
Obsttortenboden
Molde rizado



CODE	CM	H CM	PZ	PACK	EAN
15763	ø 25	3	2	12	8006043 008722

Confezione: sacchetto trasparente / Packaging: transparent bag

PIROTTINI E MUFFINS - PAPER CUPCAKES AND MUFFINS

Pirottini

Paper cupcakes
Barquettes en papier
Papier-backförmchen
Moldes papel



CODE	CM	H CM	PZ	PACK	EAN
15749	ø 7	3	100	12	8006043 008586

Confezione: sacchetto trasparente / Packaging: transparent bag

Pirottini

Paper cupcakes
Barquettes en papier
Papier-backförmchen
Moldes papel



CODE	CM	H CM	PZ	PACK	EAN
15751	ø 4,3	2,3	100	12	8006043 008609
15750	ø 7	3	100	12	8006043 008593

Confezione: sacchetto trasparente / Packaging: transparent bag

Pirottini tulipano

Tulip paper cupcakes
Cupcakes tulip en papier
Papier-backförmchen tulip
Moldes papel tulip



CODE	CM	H CM	PZ	PACK	EAN
15752	ø 7,5	8	12	12	8006043 008616

Confezione: sacchetto trasparente / Packaging: transparent bag

Muffins

Paper muffins
Barquettes en papier
Papier-backförmchen
Moldes papel



CODE	CM	H CM	PZ	PACK	EAN
15753	ø 5	4	6	12	8006043 008623

Confezione: sacchetto trasparente / Packaging: transparent bag

VASSOI IN CARTONCINO - PAPER TRAYS

Vassoio bianco cartoncino

White paper tray
Plateau carton couleur blanc
Weissenen Papierfach
Bandeja de papel blanco



CODE	CM	PZ	PACK	EAN
15745B	23 x 31	3	12	8006043 010237
15793	28 x 42	2	12	8006043 013436
15742	33 x 43	2	12	8006043 008517

Confezione: sacchetto trasparente / Packaging: transparent bag

Vassoio oro cartoncino

Golden paper tray
Plateau carton couleur or
Goldenen Papierfach
Bandeja de papel dorado



CODE	CM	PZ	PACK	EAN
15794	ø 24	3	12	8006043 013450
15743	ø 31	3	12	8006043 008524
15744	ø 34	2	12	8006043 008531

Confezione: sacchetto trasparente / Packaging: transparent bag

Vassoio oro cartoncino

Golden paper tray
Plateau carton couleur or
Goldenen Papierfach
Bandeja de papel dorado



CODE	CM	PZ	PACK	EAN
15792C	19 x 28	3	12	8006043 013429
15745	23 x 31	3	12	8006043 008548
15793C	28 x 42	2	12	8006043 013443
15742C	33 x 43	2	12	8006043 010220

Confezione: sacchetto trasparente / Packaging: transparent bag

PIZZI E PORTA TORTE - LACE DOILIES AND CAKE CARRY BOX

Pizzi sotto torta polistirene

Plastic lace doilies
Napperons plastique
Plastic-tortenspitzen
Encaje bajo-cake en plástico



CODE	CM	PZ	PACK	EAN
15740	ø 32	2	12	8006043 008494

Confezione: sacchetto trasparente / Packaging: transparent bag

Pizzi sotto torta carta

Lace doilies
Napperons papier
Papier-tortenspitzen
Encaje bajo-cake

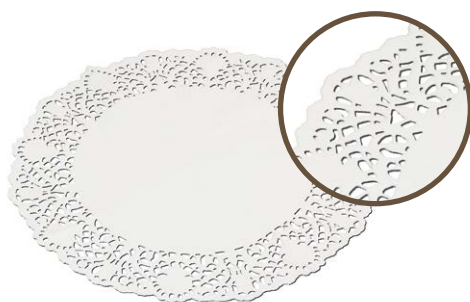

CODE	CM	PZ	PACK	EAN
15746	ø 28	5	12	8006043 008555

Confezione: sacchetto trasparente / Packaging: transparent bag

Pizzi sotto torta carta

Lace doilies
Napperons papier
Papier-tortenspitzen
Encaje bajo-cake



CODE	CM	PZ	PACK	EAN
15747	ø 36	5	12	8006043 008562

Confezione: sacchetto trasparente / Packaging: transparent bag

Pizzi sotto torta carta

Lace doilies
Napperons papier
Papier-tortenspitzen
Encaje bajo-cake

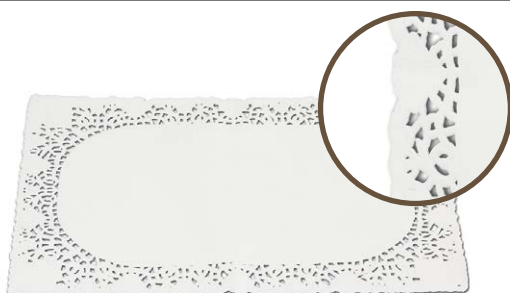

CODE	CM	PZ	PACK	EAN
15748	20 x 30	5	12	8006043 008579
15780	30 x 40	5	12	8006043 010183

Confezione: sacchetto trasparente / Packaging: transparent bag

Scatola porta torte

Cake carry box
Boîte emporte-gâteaux
Tortenschachtel
Cajas para tartas



CODE	CM	H CM	PZ	PACK	EAN
15761	29 x 29	9	1	12	8006043 008708
15767	33 x 33	11,5	1	12	8006043 010169

Confezione: sacchetto trasparente / Packaging: transparent bag

Sotto torta oro cartoncino

Golden cake board
Sous-gâteau couleur or
Gold tortenuntersätze
Subpastel oro



CODE	CM	PZ	PACK	EAN
15765	ø 32	2	12	8006043 008746

Confezione: sacchetto trasparente / Packaging: transparent bag

RICORRENZE - CELEBRATIONS

Stampo colomba

"Colomba" shaped paper mould
Forme "Colomba" en papier
"Colomba" form in Backpapier
Forma "Colomba" en papel



CODE	CM	H CM	PZ	PACK	EAN
157811	19,6 x 27,5 (500 g)	5	3	12	8006043 023305
157821	23,5 x 33 (1000 g)	6,5	2	12	8006043 023312

Confezione: sacchetto trasparente / Packaging: transparent bag



Stampo albero

Xmas tree paper baking mould
Forme sapin de Noël en papier
Baumform in Backpapier
Forma arbol de Navidad en papel



CODE	CM	H CM	PZ	PACK	EAN
15766	25 x 32 (900 g)	6	2	12	8006043 008753

Confezione: sacchetto trasparente / Packaging: transparent bag

Stampo stella

Star shaped paper mould
Forme étoile en papier
Sternform in Backpapier
Forma estrella en papel



CODE	CM	H CM	PZ	PACK	EAN
15768	25 x 21 (500 g)	6	3	12	8006043 008777

Confezione: sacchetto trasparente / Packaging: transparent bag

Panettone alto

Panettone baking mould
Moule à panettone
Panettone backform
Molde panettone



CODE	CM	H CM	PZ	PACK	EAN
15769	ø 15,5 (750 g)	11,5	2	12	8006043 008784

Confezione: sacchetto trasparente / Packaging: transparent bag

Panettone basso

Panettone baking mould
Moule à panettone
Panettone backform
Molde panettone



CODE	CM	H CM	PZ	PACK	EAN
15770	ø 19 (750 g)	6	3	12	8006043 008791

Confezione: sacchetto trasparente / Packaging: transparent bag

VASSOI IN PLASTICA - PLASTIC TRAYS

Vassoio crystal polistirene

Plastic tray
Plateau en plastique
Tablett in Plastik
Bandeja de plástico



CODE	CM	PZ	PACK	EAN
15777	ø 27	3	12	8006043 010176
15741	ø 33	2	12	8006043 008760

Confezione: sacchetto trasparente / Packaging: transparent bag

Vassoio oro PET-PET

Plastic golden tray
Plateau en plastique couleur or
Goldenen Tablett in Plastik
Bandeja de plástico dorado



CODE	CM	PZ	PACK	EAN
15764	ø 28	2	12	8006043 008739

Confezione: sacchetto trasparente / Packaging: transparent bag

Vassoio ovale polistirene

Plastic tray
Plateau en plastique
Tablett in Plastik
Bandeja de plástico



CODE	CM	PZ	PACK	EAN
15778	46 x 23	2	12	8006043 008890

Confezione: sacchetto trasparente / Packaging: transparent bag

Mini display

Cubic mini box
Mini présentoir cubique
Kubisch Mini Box
Mini expositor cubico



CM	H CM
60 x 40	100

Espositore con ripiani modulabili

Display
Présentoir
Display
Expositor



CM	H CM
57,5 x 38	112

La linea Easy Bake è disponibile in un pratico espositore, che permette di allestire il punto vendita e presentare la linea in modo ordinato e attraente.

The Easy Bake range dedicated display is the ideal solution to lay out the products in the store.



Guardini®

134-141

SILICONE SILICONE

STAMPI IN SILICONE
SILICONE MOULDS

136 Juliette



- Più pratici in cucina
- Flessibili ed antiaderenti
- Sformabilità facile e perfetta
- Semplici da pulire

- Handy and practical for your baking
- Easy storage
- Easy food release
- Easy cleaning after use



+260°C

-40°C





Guardini

FORNO
FOUR - TRADITIONAL OVEN
FREEZER
CONGELATEUR - FREEZER
MICROONDE
MICRO-ONDES - MICROWAVE



-40°C

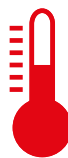

+260°C

ANTIADERENTE - Massima flessibilità
NON-STICK - Great flexibility | ANTI-ADHÉRENT - Flexibilité maximale





Juliette



Juliette è una linea completa di stampi in silicone per cottura e surgelazione, flessibili ed antiaderenti. Gli stampi in silicone consentono una sfornabilità facile e perfetta, inoltre possono essere riposti con facilità ovunque, sono semplici da pulire, sia a mano che in lavastoviglie.

Gli stampi Juliette sono interamente realizzati in puro silicone alimentare, un materiale conforme alle più severe norme internazionali che regolano l'utilizzo di materiali destinati al contatto con gli alimenti. Ideali per la cottura e la surgelazione, gli stampi in silicone possono essere utilizzati nel forno tradizionale, nel microonde, in frigorifero e nel freezer, perché il silicone alimentare può resistere a temperature da -40°C a 260°C.

Juliette is a complete range of flexible and non-stick silicone pans. Thanks to the material characteristics, they could be stored anywhere, they are easy to clean and suitable to use in oven, microwave, freezer and dishwasher.

Juliette pans are entirely made of platinum silicone in compliance with stringent international standards for food-safe materials. Suitable for cooking and freezing, silicone pans can be used in traditional ovens, microwaves, refrigerator, and even in the freezer because they resist temperatures from -40°C to 260°C.

VISTA FRONTE - FRONT VIEW



VISTA RETRO - BACK VIEW



MADE in ITALY

Tortiera liscia

Round cake tin
Moule à clafoutis
Kuchenform
Molde tarta lisa



CODE	CM	H CM	PACK	EAN
69124EE	ø 24	4,5	6	8006043 691245

Confezione: fascia in cartoncino appendibile / Packaging: with hangable carton label

Gugelhupf

Bundtform
Kugelhupf
Gugelhupf
Flanera con cono



CODE	CM	H CM	PACK	EAN
69250EE	ø 22	10,7	6	8006043 692501

Confezione: fascia in cartoncino appendibile / Packaging: with hangable carton label

Stampo corolla

Flower cake pan
Moule à fleur
Backform corolla
Molde flor



CODE	CM	H CM	PACK	EAN
69220EE	ø 22	5	6	8006043 692204

Confezione: fascia in cartoncino appendibile / Packaging: with hangable carton label

Stampo ciambella

Savarin cake pan
Moule à savarin
Kranzform
Molde savarin



CODE	CM	H CM	PACK	EAN
69224EE	ø 24	5,5	6	8006043 692242

Confezione: fascia in cartoncino appendibile / Packaging: with hangable carton label

Stampo plumcake

Loaf tin
Moule à cake
Königskuchenform
Molde plumcake



CODE	CM	H CM	PACK	EAN
69326EE	24 x 13	6,5	6	8006043 693263

Confezione: fascia in cartoncino appendibile / Packaging: with hangable carton label

Stampo 6 muffins

6 Muffins pan
Plaque à 6 muffins
6 Muffinform
Molde 6 muffins



CODE	CM	H CM	PACK	EAN
69023EE	16,5 x 25	3,5	6	8006043 690231

Confezione: fascia in cartoncino appendibile / Packaging: with hangable carton label

Stampo 6 briochettes

6 briochettes baking pan
Plaque à 6 briochettes
6 briochettes backenform
Molde 6 briochettes



CODE	CM	H CM	PACK	EAN
69034EE	17 x 29	3,8	6	8006043 690347

Confezione: fascia in cartoncino appendibile / Packaging: with hangable carton label

Stampo 6 cuori

6 hearts baking pan
Plaque à 6 coeurs
6 harten backenform
Molde 6 corazones



CODE	CM	H CM	PACK	EAN
69040EE	17 x 22,5	3,8	6	8006043 690408

Confezione: fascia in cartoncino appendibile / Packaging: with hangable carton label

9 Mini plumcake

9 Mini cakes
9 Mini cakes
9 Mini Kuchen
9 Mini bizcochos



CODE	CM	H CM	PACK	EAN
69327EE	17 x 29,5	3	6	8006043 693270

Confezione: fascia in cartoncino appendibile / Packaging: with hangable carton label

24 Mini bordelais

24 mini bordelais baking pan
Plaque 24 mini bordelais
Backform für 24 mini bordelais
Molde para 24 mini bordelais



CODE	CM	H CM	PACK	EAN
69052EE	17 x 28,5	3,5	6	8006043 690521

Confezione: fascia in cartoncino appendibile / Packaging: with hangable carton label

Tappetino da forno multiuso

Baking mat

Feuille à pâtisserie multi-usages

Backmatte

Salva bandejas



CODE	CM	H CM	PACK	EAN
69429EE	29 x 39	0,2	6	8006043 694291

Confezione: fascia in cartoncino appendibile / Packaging: with hangable carton label

6 Pirottini

6 Cupcakes

6 Caissettes

6 Muffinform

6 Moldes para horno



CODE	CM	H CM	PACK	EAN
69107EE	ø 6,5	3	6	8006043 691078

Confezione: fascia in cartoncino appendibile / Packaging: with hangable carton label





Guardini®

142-147

CERAMICA CERAMIC

PIROFILE IN CERAMICA
CERAMIC BAKEWARE

144 Ceramica / Ceramic



- Versatile
- Ideale per il forno a microonde
- Dal frigo al forno
- Da -18°C a + 250°C

- Versatile
- Ideal for the microwave
- From the freezer to the oven
- From -18°C to + 250°C





Guardini



-18°C

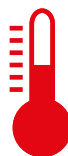

+250°C



CERAMICA



Una linea completa di stampi da forno in ceramica bianca, che ripropone in modo attuale i metodi e i materiali della cottura tradizionale. Adatti per il forno tradizionale, quello a microonde e perfetti anche come piatti da portata.

Gli stampi da forno in ceramica bianca sono realizzati con un materiale idoneo a garantire la resistenza alle alte temperature e agli shock termici. Estremamente resistenti agli urti, questi strumenti di cottura costituiscono la risposta avanzata per un uso ultra intensivo e per una lunga durata.

A complete range of white ceramic oven dishes, that recreates the traditional baking methods with the most modern materials.

For your convenience, all our ceramic moulds are both microwave and oven-safe and they can go directly from freezer to oven, since they resist to thermal shocks. Their simple white design is perfect for any kitchen and tabletop décor.

The white ceramic is made of a material suitable for high temperatures and it is the forefront for heavyduty use and durability.



Ovale grande

Oval dish
Ovale
Ovales backblech
Molde oval



CODE	CM	H CM	PACK	EAN
C00TC1	36 x 24	6,8	6	8006043 900361

Confezione: etichetta adesiva / Packaging: sticker

Ovale medio

Oval dish
Ovale
Ovales backblech
Molde oval



CODE	CM	H CM	PACK	EAN
C00TC3	30 x 18	6	6	8006043 900323

Confezione: etichetta adesiva / Packaging: sticker

Ovale piccolo

Oval dish
Ovale
Ovales backblech
Molde oval



CODE	CM	H CM	PACK	EAN
C00TC4	22 x 14	5	12	8006043 930221

Confezione: etichetta adesiva / Packaging: sticker

Rettangolare grande

Rectangular dish
Rectangulaire
Rechteckiges Backblech
Molde rectangular



CODE	CM	H CM	PACK	EAN
C00TC7	36 x 24	6	6	8006043 905366

Confezione: etichetta adesiva / Packaging: sticker

Rettangolare medio

Rectangular dish
Rectangulaire
Rechteckiges Backblech
Molde rectangular



CODE	CM	H CM	PACK	EAN
C0TC7A	30 x 18	6,5	6	8006043 905304

Confezione: etichetta adesiva / Packaging: sticker

Rettangolare piccolo

Rectangular dish
Rectangulaire
Rechteckiges Backblech
Molde rectangular



CODE	CM	H CM	PACK	EAN
C0TC7C	22 x 14	5,5	12	8006043 935226

Confezione: etichetta adesiva / Packaging: sticker

Quadro medio

Square dish
Carré
Quadratisches Minibackblech
Molde cuadrado



CODE	CM	H CM	PACK	EAN
C0TC22	25 x 22	5,5	6	8006043 910254

Confezione: etichetta adesiva / Packaging: sticker

Quadro piccolo

Square dish
Carré
Quadratisches Minibackblech
Molde cuadrado



CODE	CM	H CM	PACK	EAN
CTC22C	18 x 16	4,5	12	8006043 940183

Confezione: etichetta adesiva / Packaging: sticker

Tortiera

Flan dish
Moule à tarte
Tortenform
Molde tarta



CODE	CM	H CM	PACK	EAN
C00L12	ø 29	4,5	6	8006043 925296

Confezione: etichetta adesiva / Packaging: sticker

Crème-caramel

Ramekin
Crème-caramel
Crème-caramel
Flanera individual



CODE	CM	H CM	PACK	EAN
C00TC9	ø 9	5,2	12	8006043 015201

Confezione: etichetta adesiva / Packaging: sticker



Guardini

148-161

ACCESSORI *GADGETS*

ACCESSORI *GADGETS*

- 150 Stampi per friggitrice ad aria / *Moulds for air fryer* **NEW**
- 154 Ricorrenze / *Celebrations*
- 157 Tagliabiscotti / *Cookie cutters* **NEW**
- 158 Coppapasta / *Food rings*
- 160 Anelli regolabili / *Extendable cake rings*



- Versatili
- Funzionali
- Molteplici utilizzi
- Facili da usare

- *Versatile*
- *Functional*
- *Multiple uses*
- *Easy to use*



Guardini



**FRIGGITRICE AD ARIA
AIR FRYER
FRITEUSE A AIR**



STAMPI PER FRIGGITRICE AD ARIA

NEW



La linea di stampi per friggitrice ad aria è composta da stampi in carta da forno monouso e da stampi in silicone.

Questi stampi sono facili da usare, proteggono il cestello della friggitrice da sporco e residui di cibo per una maggiore durata e sono compatibili con diverse marche di friggitrici ad aria.

La **carta da forno monouso** per friggitrice ad aria è facile da utilizzare e da smaltire, rendendo la pulizia della cucina ancora più semplice e veloce. Temperatura massima di utilizzo **220°C**.

Il **silicone** è **flessibile** e grazie alla sua superficie antiaderente consente di cuocere cibi senza grassi aggiunti ed è facile da pulire. Temperatura massima di utilizzo **260°C**.

The range of moulds for air fryer is made of disposable baking paper and silicone moulds.

These moulds are easy to use, they protect the fryer basket from dirt and food residues to ensure a longer life, and they are compatible with different brands of air fryers.

*The **disposable paper** air fryer baking moulds are easy to use and dispose of, making kitchen cleaning even easier and faster. Maximum operating temperature **220°C**.*

*The **silicone moulds** are **flexible** and, thanks to their non-stick surface, they allow you to cook foods without added fat. Moreover, they are also very easy to clean. Maximum operating temperature **260°C**.*



Stampo muffin in carta

*Paper muffin mold
Barquette en papier cuisson
Papier-backförmchen
Moldes papel*



CODE	CM	H CM	PZ	PACK	EAN
15830AIR	ø 8,5	8	12	12	8006043 022414

Confezione: sacchetto trasparente / Packaging: transparent bag

**MONOUSO
DISPOSABLE**

Stampo rettangolare in carta

*Rectangular baking paper
Moule rectangulaire en papier cuisson
Rechteckige backpapierform
Molde de papel de horno rectangular*



CODE	CM	H CM	PZ	PACK	EAN
15758AIR	19 x 8,7	5,5	4	12	8006043 022421

Confezione: sacchetto trasparente / Packaging: transparent bag

**MONOUSO
DISPOSABLE**

Stampo tondo in carta

*Round baking paper mould
Moule rond en papier cuisson
Runde Backpapierform
Molde De Papel Redondo*



CODE	CM	H CM	PZ	PACK	EAN
15832AIR	ø 13,5	3	6	12	8006043 022384
15833AIR	ø 19	3,7	4	12	8006043 022889

Confezione: sacchetto trasparente / Packaging: transparent bag

**MONOUSO
DISPOSABLE**

Stampo tondo in carta

*Round baking paper mould
Moule rond en papier cuisson
Runde Backpapierform
Molde De Papel Redondo*



CODE	CM	H CM	PZ	PACK	EAN
15834AIR	ø 17	6	6	12	8006043 022391

Confezione: sacchetto trasparente / Packaging: transparent bag

**MONOUSO
DISPOSABLE**

Stampo tondo in carta

Round baking paper mould
Moule rond en papier cuisson
Runde Backpapierform
Molde De Papel Redondo



CODE	CM	H CM	PZ	PACK	EAN
15878AIR	ø 18,5	4,2	16	12	8006043 022407

Confezione: sacchetto trasparente / Packaging: transparent bag

**MONOUSO
DISPOSABLE**

Pirottino in silicone

Silicone baking cups
Barquettes en silicone
Silikon muffinform
Molde de silicona



CODE	CM	H CM	PZ	PACK	EAN
69107AIR	ø 7	3,2	4	6	8006043 022377

Confezione: sacchetto trasparente / Packaging: transparent bag

Stampo tondo in silicone

Round silicone mould
Moule rond en silicone
Runde silikonform
Molde redondo de silicona



CODE	CM	H CM	PZ	PACK	EAN
69120AIR	ø 21,5	3,8	1	6	8006043 022360

Confezione: sacchetto trasparente / Packaging: transparent bag

Stampo rettangolare in silicone

Rectangular silicone mould
Moule rectangulaire en silicone
Rechteckige silikonform
Molde de silicona rectangular



CODE	CM	H CM	PZ	PACK	EAN
69325AIR	22,8 x 12,5	5,9	1	6	8006043 022353

Confezione: sacchetto trasparente / Packaging: transparent bag

RICORRENZE



Gli eventi promozionali di Guardini sono sempre dei momenti importanti, ricchi di fantasia, di colore e di convenienza. Per queste occasioni Guardini presenta diversi prodotti per valorizzare l'offerta sul lineare e stimolare il piacere della cucina. Pasqua, Halloween e Natale sono le ricorrenze raggruppate nell'offerta Guardini. Pirottini e tagliabiscotti a tema daranno colore, forma e allegria alle feste più attese.

Guardini promotional events are always important moments, full of fantasy and colours. For these occasions Guardini presents different products that could provide value to the shops and make holiday baking a joy.

With this line Guardini celebrates: Easter, Halloween and Christmas. Cupcakes and cookie cutters will give your holidays the perfect shape, colour and happiness.

PASQUA

Tagliabiscotti Pasqua

NEW

Easter cookie cutters
Emporte-pièces Pâques
Ostern Ausstechformen
Cortador de Galletas Pascua



CODE	PACK	EAN
15836	12	8006043 023008

Confezione: blister / Packaging: blister

6
PCS

HALLOWEEN

Pirottini da forno

Paper cupcakes
Barquettes en papier
Muffin-Papierbackförmchen
Moldes papel



CODE	CM	H CM	PZ	PACK	EAN
15828	ø 7	2,6	60	12	8006043 019155

Confezione: sacchetto trasparente / Packaging: transparent bag

Tagliabiscotti Halloween

Halloween cookie cutters
Découpe-pâtes Halloween
Halloween Ausstechformen
Corta galletas Halloween

4
PCS



CODE	PACK	EAN
15651	12	8006043 156515

Confezione: blister / Packaging: blister

NATALE - CHRISTMAS

Tagliabiscotti Natale

Christmas cookie cutters
Découpe-pâtes Noël
Weihnachten Ausstechformen
Corta galletas Navidad

6
PCS



CODE	PACK	EAN
15654	12	8006043 156546

Confezione: blister / Packaging: blister

Tagliabiscotti Pan di Zenzero

Gingerbread cookie cutters
Découpe-pâtes "Le bonhomme pain d'épice"
Lebkuchen Ausstechformen sortiert
Corta galletas "El hombrecito de pan de gengibre"

4
PCS



CODE	PACK	EAN
15660	12	8006043 156607

Confezione: blister / Packaging: blister

3D Tagliabiscotti natalizi

3D Christmas cookie cutters
3D Emporte-pièces de Noël
3D Weihnachten Ausstechformen
3D Cortagalletas de Navidad

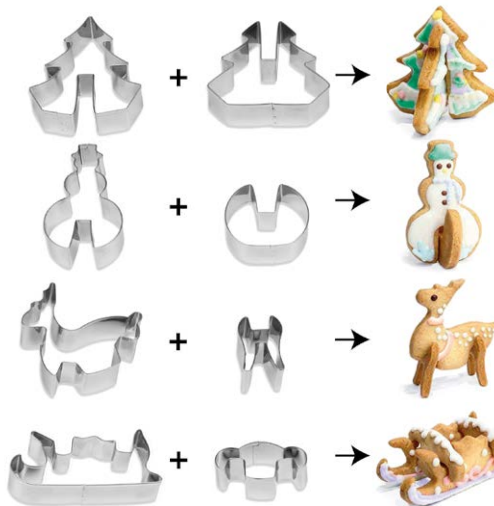

CODE	PACK	EAN
15802	6	8006043 015515

Confezione: astuccio / Packaging: box

Anello con 8 Tagliabiscotti

Ring with 8 cookie cutters
Anneau avec 8 découpe-pâtes
Ring mit 8 hausstechenformen
Anillo de 8 corta galletas



CODE	PACK	EAN
15632E	24	8006043 008418

Confezione: astuccio / Packaging: box



Display Albero di Natale con 110 anelli da 8 tagliabiscotti

Christmas tree with 110 rings of 8 cookie cutters
Sapin de Noël avec 110 anneaux de 8 découpe-pâtes
Tannenbaum-standdisplay mit 110 ringe von 8 hausstechenformen
Arbol de Navidad con 110 anillos de 8 corta galletas

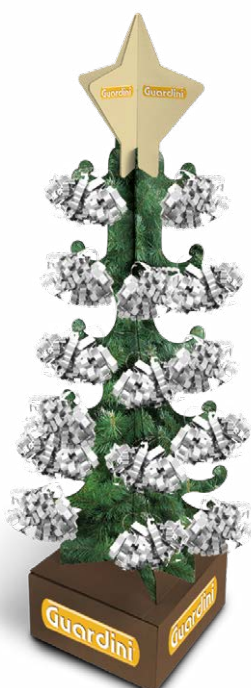

CODE	CM	H CM	PACK	EAN
15785A	40 x 40	160	1	8006043 010848



NEW

I tagliabiscotti dalle forme classiche non possono mancare nell'offerta Guardini. Realizzati in banda stagnata, sono adatti al contatto con gli alimenti. Sono gli utensili ideali per creare dei biscotti di forme diverse e varie.

Cookie cutters with classic shapes can not miss in the Guardini catalogue. Made of tinplate, they are suitable for contact with food. They are the ideal tools to create cookies of different shapes and various.

Tagliabiscotti

Cookie cutters
Emporte-pièces
Ausstechformen
Cortador de Galletas

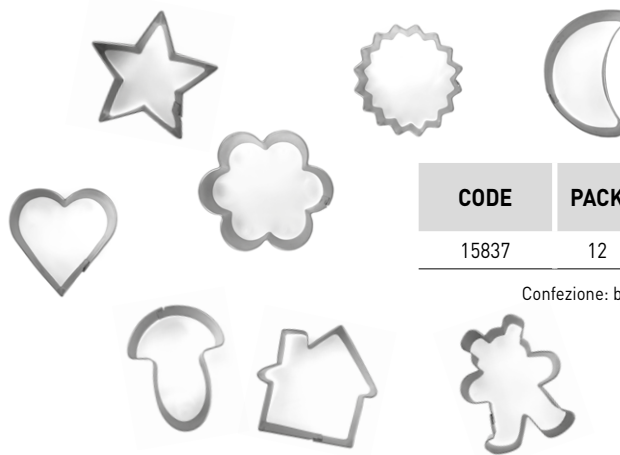

CODE	PACK	EAN
15837	12	8006043 023015

Confezione: blister / Packaging: blister

8
PCS

Tagliabiscotti animali

Animal Cookie cutters
Emporte-pièces Animaux
Ausstechformen Tiere
Cortador de Galletas Animales

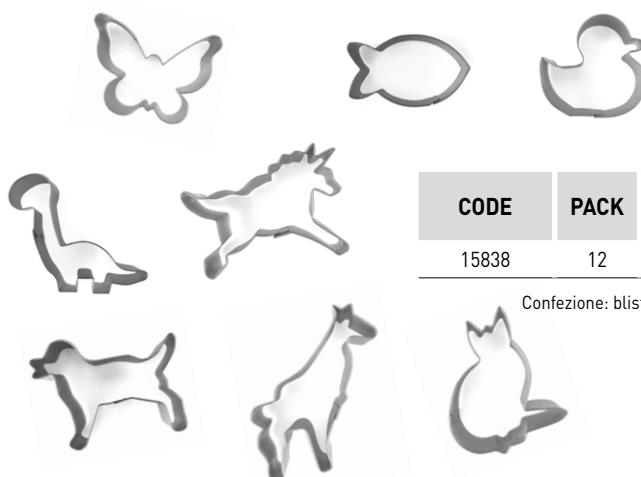

CODE	PACK	EAN
15838	12	8006043 023022

Confezione: blister / Packaging: blister

8
PCS



COPPAPASTA



I coppapasta Guardini sono ideali per tagliare la pasta, per creare dolci o per impiattare a piacimento riso, sformati di verdure, tartare, cucinati in modo originale, elegante e raffinato.

I coppapasta Guardini sono realizzati in acciaio inox e sono disponibili in varie forme e dimensioni. Questi permetteranno anche ai cuochi più esigenti di sbizzarrirsi in cucina e creare piatti originali e sfiziosi.

The Guardini food rings are ideals for cutting the dough in several shapes, create desserts or to serve rice, vegetable pies, tartar in an original, elegant and refined way.

The Guardini food rings are made of stainless steel and come in various shapes and sizes. They will enable even the most demanding chefs to indulge in the kitchen and create original and delicious dishes.

Coppapasta tondo con stantuffo

Round food ring with pusher

Cercle à pâtisserie

rond avec poussoir

Food-Ring (Rund)

Aro redondo con pisador



CODE	CM	H CM	PACK	EAN
15663	ø 7	6	12	8006043 156638

Confezione: astuccio trasparente / Packaging: transparent box



Coppapasta rettangolare con stantuffo

Rectangular food ring with pusher

Cercle à pâtisserie

rectangulaire avec poussoir

Food-Ring (Rechteckig)

Aro rectangular con pisador



CODE	CM	H CM	PACK	EAN
15665	9 x 5	6	12	8006043 156652

Confezione: astuccio trasparente / Packaging: transparent box



Coppapasta quadrato con stantuffo

Square food ring with pusher

Cercle à pâtisserie carré avec poussoir

Food-Ring (Viereckig)

Aro cuadrado con pisador



CODE	CM	H CM	PACK	EAN
15666	6 x 6	6	12	8006043 156669

Confezione: astuccio trasparente / Packaging: transparent box



Coppapasta cuore con stantuffo

Heart food ring with pusher

Cercle à pâtisserie coeur avec poussoir

Food-Ring (Herzform)

Aro corazon con pisador



CODE	CM	H CM	PACK	EAN
15667	6 x 6	6	12	8006043 156676

Confezione: astuccio trasparente / Packaging: transparent box



Coppapasta ovale con stantuffo

Oval food ring with pusher

Cercle à pâtisserie oval avec poussoir

Food-Ring (Oval)

Aro oval con pisador



CODE	CM	H CM	PACK	EAN
15668	9 x 5	6	12	8006043 156683

Confezione: astuccio trasparente / Packaging: transparent box





ANELLI REGOLABILI

Gli anelli regolabili per torte sono lo strumento ideale per creare torte e per chi ama la pasticceria.

Permettono di cuocere facilmente in forno torte di dimensioni variabili, dalle più piccole alle più grandi. Disponibili in formato tondo o rettangolare, sono facili da regolare e da utilizzare, oltre che da pulire dopo l'utilizzo.

The extendable cake rings are the ideal tool to create cakes and for those who love pastry.

They allow you to easily bake cakes of varying sizes, from the smallest to the largest. Available in round or rectangular format, they are easy to adjust and use, as well as clean after use.

Anello regolabile tondo

Round extendable cake ring
Cadre à pâtisser réglable rond
Runder verstellbarer Tortenring
Molde redondo extensible



CODE	CM	H CM	PACK	EAN
15689R	ø 16	6	6	8006043 001501
	▼			
	ø 28			

Confezione: astuccio appendibile / Packaging: hangable box

Anello regolabile rettangolare

Rectangular extendable cake ring
Cadre à pâtisser réglable rectangle
Rechteckiger verstellbarer Backrahmen
Molde rectangular extensible



CODE	CM	H CM	PACK	EAN
15690R	18 x 27,5	5	6	8006043 001518
	▼			
	33 x 52,5			

Confezione: astuccio appendibile / Packaging: hangable box





Guardini®



IDEE REGALO GIFT IDEAS



Guardini riunisce in questa sezione le **Scatole Regalo**. Queste confezioni soddisfano tutte le esigenze e le necessità di chi vuole fare o farsi un regalo originale, divertente e completo, con tutta la qualità che da sempre contraddistingue i prodotti Guardini.

In this section, Guardini gathers together all the **Gift Boxes**. These gift boxes meet all the needs of those who want to treat themselves or buy someone else a funny, complete and original gift, with the quality guarantee that distinguishes the Guardini products.

Starting Set

Set 4 stampi da forno

Set of 4 non-stick coating moulds

Lot de 4 moules à gâteaux anti-adhérents

Backformen-set (4 tlg)

Set 4 moldes en acero antiadherente



CODE	CM	PACK	EAN
89992	30 x 35 x 15	4	8006043 013658

Confezione: scatola / Packaging: box

La scatola **Starting set** contiene un set di 4 stampi:

- 1 tortiera apribile 1 fondo con salvagocchia (ø 24 cm)
- 1 stampo crostata (ø 28 cm)
- 1 stampo plumcake (30 cm)
- 1 stampo budino con cono (ø 23 cm)

Tutti gli stampi sono realizzati in acciaio Hi-Top con rivestimento antiaderente doppio strato.

The **Starting set** gift box contains:

- 1 springform 1 base with leakproof base (ø 24 cm)
- 1 flan tin (ø 28 cm)
- 1 loaf tin (30 cm)
- 1 bundtform (ø 23 cm)

All these moulds are made of Hi-Top steel with double layer of non-stick coating.

Chocoforme

Set 3 stampi da forno

Set of 3 non-stick coating moulds

Lot de 3 moules à gâteaux anti-adhérents

Backformen-set (3 tlg)

Set 3 moldes en acero antiadherente



CODE	CM	PACK	EAN
00737H	30 x 30 x 13,5	4	8006043 000573

Confezione: scatola / Packaging: box

La scatola regalo della linea **Chocoforme** contiene un set di 3 stampi:

- 1 tortiera apribile 1 fondo con salvagocchia (ø 26 cm)
- 1 stampo crostata (ø 28 cm)
- 1 stampo plumcake (25 cm)

Tutti gli stampi sono realizzati in acciaio Hi-Top con rivestimento antiaderente doppio strato.

Chocoforme gift box contains:

- 1 springform 1 base with leakproof base (ø 26 cm)
- 1 flan tin (ø 28 cm)
- 1 loaf tin (25 cm)

All these moulds are made of Hi-Top steel with a double layer of non-stick coating.

Set 10 pezzi pizza

Gift box (10 pcs set)
Boîte cadeau (lot de 10 pièces)
Geschenkspaket (10 Stück)
Caja regalo (10 piezas)



CODE	CM	PACK	EAN
27514RK	34 x 34 x 8	4	8006043 275148

Confezione: scatola / Packaging: box

La scatola contiene:

- 1 griglia porta pizze (la struttura d'acciaio che permette di cuocere contemporaneamente 4 pizze)
- 4 tegami pizza da ø 32 cm
- 4 coltelli pizza e 1 rotella taglia pizza in nylon, da utilizzare anche sui tegami perché non graffia la superficie antiaderente e ne lascia intatte le caratteristiche di antiaderenza.

Tutti gli stampi sono realizzati in acciaio Hi-Top con rivestimento antiaderente doppio strato.

The box contains:

- 1 Pizza Rack (a steel wire holder that permits to bake 4 pizzas at the same time)
- 4 pizza tins (ø 32 cm)
- 4 pizza knives and 1 nylon pizza cutter, suitable to slice the pizza directly in the tin, as it doesn't damage the non-stick surface.

All these moulds are made of Hi-Top steel with double layer of non-stick coating.

I love pizza - 5 pezzi

Set 4 tegami pizza + supporto in acciaio
Set 4 pizza tins with steel grill rack
Lot 4 moules à pizza avec support en acier
4 Pizzaform+pizzabäcker-set
Set 4 bandejas pizza + soporte en acero



CODE	CM	PACK	EAN
27516RK	31 x 31 x 5	4	8006043 013818

Confezione: scatola / Packaging: box

La scatola contiene:

- 1 griglia porta pizze (la struttura d'acciaio che permette di cuocere contemporaneamente 4 pizze)
- 4 tegami pizza da ø 28 cm che garantiscono la cottura perfetta e la facile sformatura di pizze di tutti i generi (realizzati in acciaio con rivestimento antiaderente doppio strato).

The box contains:

- 1 Pizza Rack (a steel wire holder that permits to bake 4 pizzas at the same time)
- 4 pizza tins (ø 28 cm) made of Hi-Top steel with double layer of non-stick coating.



Guardini

ESPOSITORI DISPLAYS



Guardini propone i **box promozionali**, utili e versatili, adatti per tutti i momenti promozionali dell'anno. **Istituzionali, adattabili a varie linee o dedicati a singoli prodotti**, sono ideali per le varie **esigenze promozionali** e perfetti **per allestire il punto vendita** in modo colorato e attraente.

Guardini offers a variety of useful and versatile **display boxes**, suitable for **sales promotions** all year round and **customizable** for single or multiple products. Besides being ideal for a wide variety of **promotional needs**, they add colour and appeal to **every store**.

**Mini display
Istituzionale**

*Cubic mini box
Mini présentoir cubique
Kubisch Mini Box
Mini expositor cubico*



CM	H CM
40 x 40	76

Mini pall box

*Mini pall box
Mini pall box
Mini pall box
Mini pall box*



CM	H CM
80 x 60	45 (senza crowner - without crowner)

Pall box

*Pall box
Pall box
Pall box
Pall box*



CM	H CM
80 x 60	82 (senza crowner - without crowner)

Mini display Pizza

Cubic mini box
Mini présentoir cubique
Kubisch Mini Box
Mini expositor cubico



CM	H CM
40 x 40	76

Mini display Easy Bake

Cubic mini box
Mini présentoir cubique
Kubisch Mini Box
Mini expositor cubico



CM	H CM
60 x 40	100

Espositore con ripiani modulabili

Display
Présentoir
Display
Expositor



CM	H CM
57,5 x 38	112



Guarda i video Guardini sul nostro canale YouTube
Watch Guardini's videos on our YouTube channel



Guardini, il piacere italiano di cucinare!
Guardini, Italian cooking delight!



Guardini, filmato aziendale, versione lunga.
Guardini, corporate movie, long version.



Guardini, filmato aziendale, versione breve.
Guardini, corporate movie, short version.



Guardini, azioni concrete per un futuro sostenibile per tutti.
Guardini, concrete actions for a sustainable future for everyone.



XBake, una bella storia che merita di essere raccontata.
XBake, a good story that deserves to be told.



XBake Guardini, la collezione di stampi da forno a ridotto impatto ambientale.
XBake Guardini, the bakeware collection with a reduced environmental impact.





Linea B-Nat: sostenibilità e qualità in una collezione 100% Made in Italy.
B-Nat line: sustainability and quality in a 100% Made in Italy collection.



Guardini - Spessore ottimizzato degli stampi in acciaio con rivestimento antiaderente

Guardini - Optimized thickness of non-stick coated steel moulds



Guardini - Rivestimenti antiaderenti di ultima generazione

Guardini - Next generation non-stick coatings



Guardini - Stampi da forno e risparmio energetico

Guardini - Baking and energy saving moulds



Guardini - Tortiere apribili con cerniera

Guardini - Springforms



Tortiera apribile 2 fondi
Springform 2 bases





Stampo crostata con fondo smontabile
Loose base flan tin



Teglia rettangolare estensibile
Adjustable baking tray



Set 4 tegami pizza + griglia porta pizze
Set 4 pizza tins with steel grill rack



Coppapasta
Food rings



Tampografia
Pad printing









GUARDINI S.p.A
Via Cravero 9 - 10088 Volpiano (To) - ITALY
Tel +39 011 9952890 - Fax +39 011 9952142
info@guardini.com
www.guardini.com

