

Guardini®



MADE in ITALY



Catalogo
Catalogue
2023



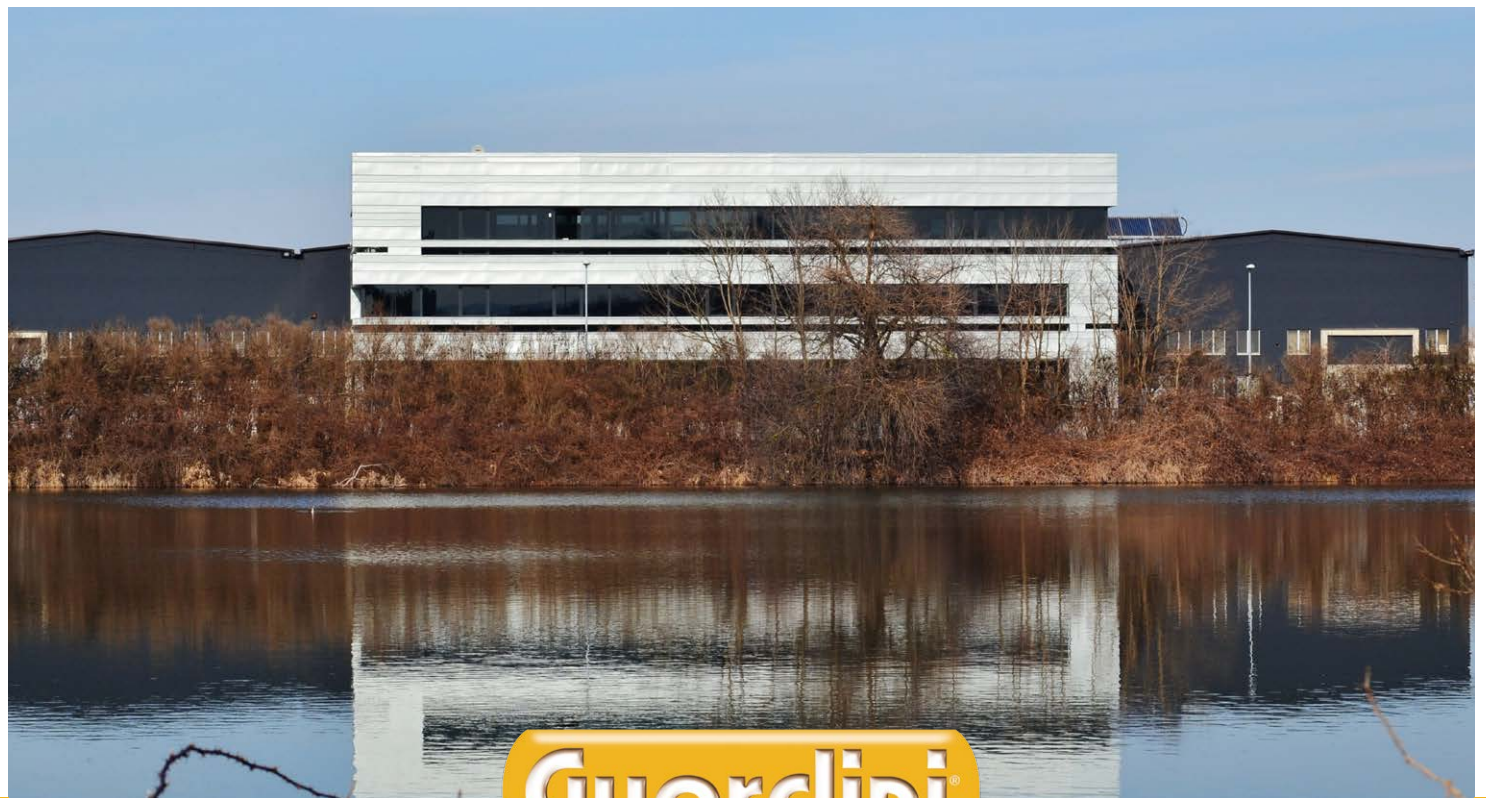

MADE in ITALY

Esperienza, Passione e Creatività Made in Italy

Da oltre **70 anni** Guardini è leader nella produzione di stampi da forno; un brand di Volpiano (To) conosciuto in tutto il mondo, che ha scritto la propria storia con passione, talento artigianale trasformato in capacità produttiva, ingegno creativo, continua ricerca e sperimentazione.

Tra passato e futuro

La storia di Guardini affonda le radici nel passato: sono trascorsi oltre 70 anni da quando a Torino viene fondata la bottega artigianale di famiglia specializzata in articoli casalinghi. Negli **anni '70** la piccola bottega si trasforma in azienda e con il tempo cresce e si specializza. Negli **anni '80** inizia la produzione dei primi stampi in acciaio con rivestimento antiaderente, oggi core business dell'azienda. Nel **1990** il brand entra in GDO e si espande fino a diventare, nel **2010**, uno dei Top European Players nella produzione di stampi da forno.

Oggi la Guardini S.p.A. è leader di mercato nella produzione di stampi da forno ed esporta l'eccellenza **Made in Italy** in tutto il mondo.

Esperienza e tradizione sono i cardini intorno ai quali nascono e maturano progetti, metodi di produzione e prodotti che guardano al futuro, moderni ed innovativi, sempre sensibili verso i nuovi trend di mercato e le esigenze di un consumatore attento ed evoluto.

Guardini. Oltre 70 anni di storie e sapori italiani.

Experience, Passion and Creativity Made in Italy

For over **70 years** Guardini has been a leader in the production of bakeware products; we are based in Volpiano (To) and our brand is world known; our history tells a story of passion, craftsmanship which translates into production ability, creative work, continuous research and experimentation.

Between past and future

Guardini's history finds its roots in the past: it has been over 70 years since the family houseware workshop was established. In the **1970s** the small workshop turned into a company and, over time, it grew and became specialized. In the **1980s**, it started the production of the first steel moulds with non-stick coating, which today are the core products of the company. In **1990** the brand entered into large scale retail channels and it expanded to become one of the Top European Players in the production of bakeware in **2010**.

Today, Guardini S.p.A. is a leading company in the production of bakeware and it exports **Made in Italy** excellence around the world.

Experience and tradition are the two key elements around which projects, production methods and future products are created and developed; our products are modern and innovative, they capture new market trends and meet the needs of demanding and attentive consumers.

Guardini. Over 70 years of italian stories and flavours.



I numeri del successo Our success translated in numbers

20 linee di prodotto a marchio Gardini / product lines under the Gardini brand



17.000 mq di area industriale / square meter plant facility



50 collezioni di Private Labels / Private Labels collections



60 forme da forno progettate e realizzate in sede / moulds designed and manufactured in-house



50.000 pezzi prodotti in sede ogni giorno / units produced in our plant every day



90 dipendenti / employees



Questi sono i numeri vincenti di un'azienda che ha saputo rinnovare e sviluppare le proprie risorse, moltiplicando le esperienze per mettere a punto una **crescita costante**. Un percorso virtuoso di "evoluzione industriale" che oggi fa di Gardini una realtà solida, riconosciuta e tecnologicamente avanzata. Sono **numerose le insegne della GDO nazionale ed internazionale** che hanno affidato a Gardini la private label e gli stampi da forno prodotti a Volpiano, i quali vengono spediti in **oltre 50 paesi in tutto il mondo**.

Il valore del Made in Italy

La produzione Gardini è per il 99% Made in Italy. Anche se il mercato di riferimento è quello italiano, l'eccellenza dei prodotti italiani Gardini ha conquistato l'estero. L'esportazione (circa il 60% del fatturato) coinvolge oggi l'Europa, i Paesi Arabi, l'America e il Nord Africa.

*These outstanding numbers show the success of a company which has been able to innovate and develop its resources, by multiplying its experience to ensure its **constant growth**. A virtuous path of "industrial evolution" that today makes Gardini a very solid, recognized and technologically advanced business. **Several national and international large scale** retail channels gave Gardini their private label and the bakeware produced in Volpiano are now shipped to **over 50 countries around the world**.*

The value of Made in Italy products

Gardini production is 99% Made in Italy. Even if its main market of reference is the Italian market, the excellence and high quality of Gardini's products has swept the world. Exports (which account for about 60% of the business turnover) include Europe, Arab countries, America and North Africa.



I prodotti: passione e qualità

Guardini è soprattutto fantasia, talento e sensibilità, che permettono di cogliere le esigenze in evoluzione, per trasformarle in prodotti e soluzioni ideali.

Sempre attenta ai gusti di chi acquista e alle necessità di chi vende, Guardini sa interpretare con creatività i desideri e i bisogni di chi ama cucinare, senza dimenticare di offrire alla distribuzione le soluzioni commerciali più efficaci.

La qualità dei materiali, la competitività dei prezzi, l'enorme varietà di forme, colori e di funzioni d'uso, fanno dei numerosi prodotti Guardini gli alleati indispensabili per chiunque voglia vivere il mondo della cucina con allegria e spirito creativo.

Il successo passa anche attraverso la continua ricerca di materiali eccellenti che garantiscono prestazioni eccezionali: **facilità di cottura e di pulizia, resistenza all'usura e sfornabilità impeccabile.**

Acciaio Hi-Top, rivestimenti antiaderenti innovativi di ultima generazione, silicone alimentare di qualità, ma anche proposte in carta da forno e ceramica. Una gamma completa di stampi ed accessori, la migliore risposta alle esigenze culinarie di chi vive con passione la cucina.

Our products: passion and quality

Guardini is especially synonymous of creativity, talent and sensitivity, which capture the changing needs and transform them into ideal products and solutions.

Always attentive to the consumers' taste and retailers' needs, Guardini knows how to creatively interpret the wishes and needs of those who love cooking, without neglecting to offer the most effective commercial solutions to its distributors.

The quality of materials, the competitiveness of prices, the wide range of shapes, colors and usages, make the numerous Guardini's products the indispensable allies of anyone wishing to live a unique cooking experience with joy and creativity.

*Success also goes through continuous research for excellent materials ensuring exceptional performances: **good for cooking, easy to clean, wear-resistant and impeccable shape of foods after removal from the moulds.***

Hi-Top steel, innovative, last-generation non-stick coating, high quality silicone for food stuffs, as well as parchment paper and ceramic solutions. A complete range of moulds and accessories and the best solution to satisfy the cooking needs of cooking lovers.





La filosofia produttiva

Guardini non si ferma mai: investe in ricerca tecnologica per offrire sempre prodotti superiori e di alta qualità.

Elevato standard di prodotto ed efficienza nel servizio al cliente per un programma di Qualità Totale: questa è la mission di Guardini.

Gli ingenti e costanti investimenti in tecnologia e ricerca e sviluppo sono uno dei segreti del successo di Guardini, che oggi vanta uno stabilimento produttivo completamente automatizzato, a garanzia di elevata produttività e competitività dei prezzi.

La flessibilità e la capacità di modulare la produzione sulle richieste del mercato hanno permesso alla Guardini di aprirsi al grande business delle private labels, ad oggi al centro dei principali progetti del trade moderno.

Questo per Guardini significa garantire qualità, volumi, versatilità

nelle personalizzazioni, rintracciabilità del prodotto, a prezzi competitivi, il tutto con **una produzione completamente italiana:** una sfida complessa, ma affrontata con successo.

I risultati? Guardini ha ottenuto la Certificazione di Qualità UNI EN ISO 9001:2015 e la Certificazione etica SA 8000:2014. La dimostrazione di un progetto in continua crescita che va oltre i traguardi raggiunti.

La Certificazione di Qualità **UNI EN ISO 9001:2015** rappresenta per GUARDINI l'impegno al miglioramento continuo delle performance aziendali, in termini di prodotto, di processo produttivo e di organizzazione aziendale.

Con la Certificazione **SA 8000:2014** GUARDINI esprime il proprio credo nella Responsabilità Sociale d'impresa, un modo di fare impresa nel rispetto delle persone e dell'ambiente che ci circonda.



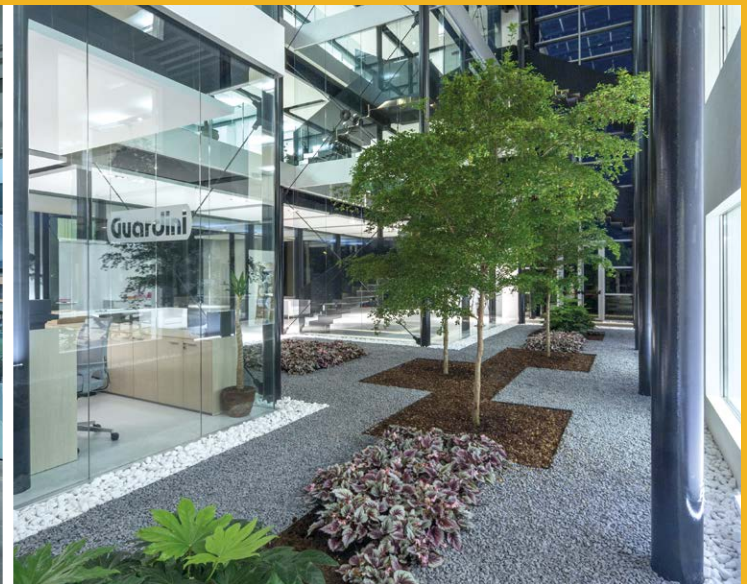

Our production philosophy

Guardini never stops: it invests in technological research in order to offer top quality products all the time.

High quality products and efficient customer service provide a Total Quality approach: this is Guardini's mission.

The substantial and constant investments in technology and research are one of the secrets of Guardini's success, which today has a fully automated production plant, designed to guarantee high productivity and price competitiveness.

Flexibility and ability to adjust production according to market demands allowed Guardini to open up to the large business of private labels, which today is at the heart of the main modern trade projects.

For Guardini this means ensuring quality, volumes, versatility

*in customization, traceability of products, at competitive prices, associated to a **fully Italian-based production**: a difficult challenge, however tackled with success.*

What are the results? Guardini obtained the UNI EN ISO 9001:2015 Quality Certification and the SA 8000:2014 Ethical Certification. This demonstrates that the project keeps on growing well beyond the already achieved objectives.

*The **UNI EN ISO 9001:2015** Quality Certification represents for GUARDINI its commitment to business performance continuous improvement, in terms of products, production process and business organization.*

*The **SA 8000:2014** Certification demonstrates GUARDINI's belief in Corporate Social Responsibility, a way of doing business that respects people and the environment.*





Guardini®

INDICE INDEX

8	STAMPI IN ACCIAIO STEEL MOULDS	60	Chocoforme
14	XBake	66	Happy Hour
20	B-Nat	72	Rossana
26	Gold Elegance	78	Bake Away
32	Silver Elegance	82	Pizza&Mania
38	Arianna	86	Ricorrenze Celebrations
44	Gardenia		
54	Bon Ton		



92 Tampografia
Pad printing

94 STAMPI IN ALLUMINIO
PRESSOFUSO
CAST ALUMINIUM
MOULDS

96 Sweet Magic

102 COLLEZIONE CARTA & PLASTICA
PAPER & PLASTIC COLLECTION

104 Easy Bake

116 STAMPI IN SILICONE
SILICONE MOULDS

118 Juliette

124 PIROFILE IN CERAMICA
CERAMIC BAKEWARE

126 Ceramica

130 ACCESSORI - GADGETS

132 Coppapasta

136 IDEE REGALO - GIFT IDEAS

142 ESPOSITORI - DISPLAYS

146 I NOSTRI VIDEO
OUR VIDEOS



Guardini®

**STAMPI IN ACCIAIO
STEEL MOULDS**



Speciale fondo salvagoccia
Leakproof base

- 14 XBake
- 20 B-Nat
- 26 Gold Elegance
- 32 Silver Elegance
- 38 Arianna
- 44 Gardenia
- 54 Bon Ton
- 60 Chocoforme

- 66 Happy Hour
- 72 Rossana
- 78 Bake Away
- 82 Pizza&Mania
- 86 Ricorrenze Celebrations
- 92 Tampografia Pad printing

- Antiaderenza
 - Eccezionali prestazioni
 - Facilità di cottura
 - Facile sformabilità e pulizia dopo l'uso
 - Tortiere apribili con speciale fondo salvagoccia
-
- Antiadhesion
 - Outstanding performance
 - Easy cooking
 - Easy food release and cleaning after use
 - Springforms with leakproof base

Guardini®

MADE in ITALY

COM'È FATTO ? HOW IS IT MADE ?

Lo stampo da forno si compone di due parti:

- 1 • **SUBSTRATO: SUPPORTO IN ACCIAIO**
- 2 • **RIVESTIMENTO ANTIADERENTE (multistrato)**

The baking mould consists of two parts:

- 1 • **SUBSTRATE: MADE OF HI-TOP STEEL**
- 2 • **NON-STICK COATING (multilayer)**

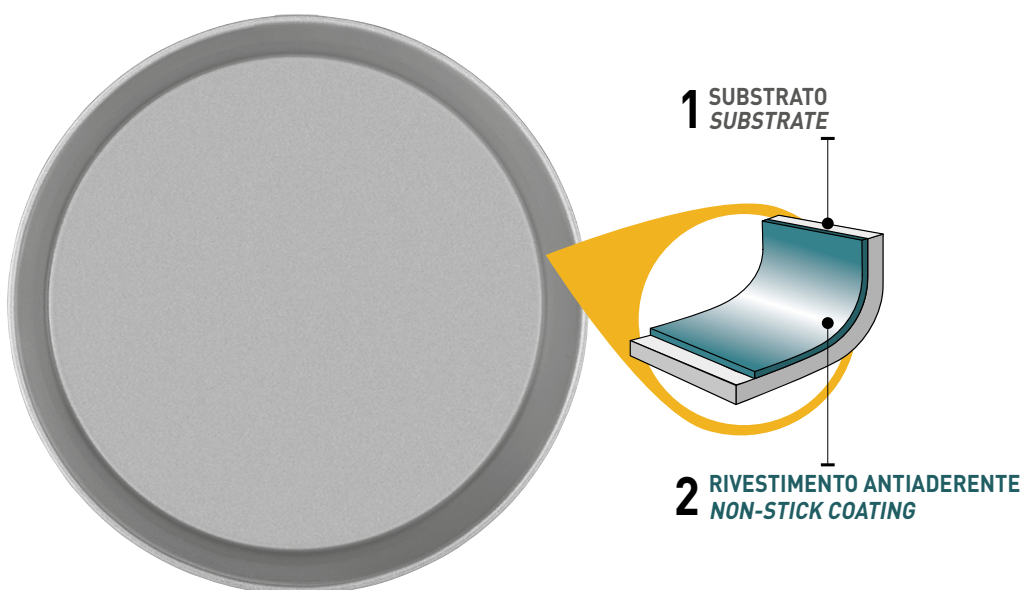

FACILE DA PULIRE
grazie all'ottima antiaderenza
EASY TO CLEAN
thanks to the excellent non-stick



RESISTENTE AI GRAFFI ED ALL'USURA
RESISTANT TO SCRATCHES AND USE

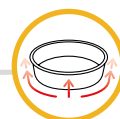

BASSO SPESSORE
per garantire un'ottima conducibilità termica
OPTIMIZED THICKNESS
guarantees excellent result for uniform cooking

1

Il substrato è realizzato in acciaio.

Il Substrato usato per la produzione degli stampi Guardini è **ECCS (Electrolytic Chromium Coated Steel)**:

- acciaio rivestito con un film di cromo;
- possiede ottime caratteristiche di resistenza alla corrosione e adesione al rivestimento;
- materiale molto elastico, qualità fondamentale per lo stampaggio;
- prodotto da acciaierie e utilizzato principalmente dai produttori europei di bakeware;
- può essere prodotto in spessori molto sottili, rendendo più adatto lo stampo alla cottura in forno.

The substrate is made of steel.

The Substrate used for the production of Guardini moulds is **ECCS (Electrolytic Chromium Coated Steel)**:

- steel coated with a chrome film;
- excellent corrosion resistance and coating adhesion properties;
- great flexibility;
- produced by tinplate mills and it is mostly used by European bakeware manufacturers;
- could be rolled at very thin gauges making it the most suitable material for cooking in the oven.

2

Caratteristiche del rivestimento antiaderente:

- bassa frizione;
- risulta essere liscio e ceroso al tatto;
- eccellente antiaderenza (l'efficacia si riduce lentamente);
- offre una buona barriera per la prevenzione delle macchie (inerte);
- alte qualità garantiscono una lunga vita del prodotto;
- buona adesione al metallo.

Characteristics of non-stick coating:

- lowest friction of any known solid;
- feels waxy and smooth to the touch;
- excellent release (effectiveness reduces slowly);
- offers good barrier to prevent staining - inert;
- premium grades offer long life;
- good adhesion to the metal.

Eccezionali prestazioni, facilità di cottura e di pulizia dopo l'uso: queste sono le caratteristiche che hanno reso le superfici antiaderenti famose in tutto il mondo.

I rivestimenti antiaderenti consentono di cucinare riducendo l'utilizzo di oli e di grassi, regole di base **per cucinare in modo sano e corretto**.

Outstanding performance, easy cooking and cleaning after use: these are the features that have made non-stick surfaces famous around the world.

The non-stick coatings permit to reduce the use of cooking oils and fats, a basic rule **for cooking in a healthy and correct way**.

Caratteristiche degli stampi con rivestimento antiaderente Characteristics of moulds with non-stick coating



Spessore ottimizzato

Minore è lo spessore dello stampo (risultando più leggero), maggiore sarà la qualità e l'uniformità della cottura. Questo perché lo stampo deve garantire il minimo ostacolo tra il composto contenuto all'interno e il forno, che è una camera chiusa dove avviene il processo della cottura.

Optimized thickness

The lower the thickness of the mould, therefore the lightness, the greater the quality and uniformity of the baking. This is because the mould must guarantee the minimum obstacle between the compound contained within it and the oven, which is a closed chamber where the cooking process takes place.

Cosa succede nel forno?

Quando una pietanza viene cotta in forno, sono coinvolti 2 fattori principali:

What happens in the oven?

When the food is put in a baking mould and placed in the oven for cooking, 2 main factors are involved:

Il forno è una camera termicamente isolata in cui il cibo viene cotto mediante **esposizione al calore**.

An oven is a thermally insulated chamber where the food is cooked by exposure to heat.

1
DIFFUSIONE
E CIRCOLAZIONE
DEL CALORE
**HEAT DIFFUSION
AND CIRCULATION**

2
CONDUZIONE
DEL CALORE
**HEAT
CONDUCTION**

È ottenuto attraverso il contatto diretto tra:

- un **corpo caldo** (stampo da forno);
- un **corpo freddo** (pietanza da cuocere).

It is obtained with direct contact between:

- a **hot body** (baking mould);
- a **cold body** (food).





MADE in ITALY

RIVESTIMENTO PRIVO DI BPA E PFOA

Da sempre tutti i **rivestimenti antiaderenti Guardini** sono assolutamente **affidabili** e adatti ad una **corretta alimentazione**, amici della salute e dell'ambiente.

- Sono **testati** ed **approvati** da istituti di controllo certificati, che applicano tutte le normative internazionali sui materiali destinati al contatto con gli alimenti.
- Consentono di cucinare con **meno grassi** a beneficio della salute.
- Sono **facili e veloci da pulire**, con minor spreco di acqua e di detersivo.
- I **cibi non attaccano** e non sviluppano quindi sostanze nocive, che potrebbero invece svilupparsi in caso di surriscaldamento e disidratazione di alcune sostanze alimentari.
- **Non contengono BPA (Bisfenolo A)**. L'azienda Guardini ha sostituito il BPA nella formulazione stessa di questi rivestimenti, eliminandolo definitivamente da tutti i materiali Low-Cure. Ha creato così una formulazione specifica di rivestimenti **"BPA FREE"**. Questo elemento sostitutivo inoltre ha permesso di migliorare notevolmente la qualità dei rivestimenti antiaderenti, in quanto:
 - riesce a creare una barriera tra il substrato dello stampo da forno ed il rivestimento che ne migliora le prestazioni di contatto alimentare evitando qualunque tipo di restrizione in riferimento agli alimenti utilizzati durante la cottura;
 - le proprietà di antiaderenza sono migliori e più performanti.
- **Non contengono PFOA**. Il Prof. Franco Battaglia, docente di chimica ambientale presso l'Università di Modena, ed il Prof. Gianni Fochi, docente di chimica presso la Scuola Normale Superiore di Pisa, hanno redatto un documento nato da un approfondito studio sui materiali antiaderenti, che **certifica l'assoluta idoneità dei rivestimenti antiaderenti in termini di sicurezza alimentare e rispetto dell'ambiente**.

Per maggiori informazioni visitare il sito www.guardini.com

COATING BPA AND PFOA FREE

- The **Guardini non-stick coatings** have always been health and environment's friends, are absolutely **reliable** and suitable for a **proper nutrition**.
- They are **tested and approved** by certified test institutes, which apply all the international rules on materials that are in contact with food.
- They allow you to cook with **less fat** for the benefit of health.
- They are **quick and easy to clean**, with less waste of water and detergent.
- The **food do not stick** to the moulds and thus they do not develop harmful substances that may originate in case of overheating and dehydration of some food products.
- **They don't contain BPA (Bisphenol A)**. Guardini replaced BPA in the formulation of these coatings, eliminating from all Low-Cure materials. Therefore, it created a specific formulation of **"BPA FREE"** coatings. Furthermore, this replacement has considerably improved the quality of non-stick coatings, inasmuch:
 - it can create a barrier between the substrate of the baking mould and the coating that improves the performance of food contact avoiding any type of restriction in reference to food used during cooking;
 - the non-stick properties are better and more efficient.
- **They don't contain PFOA**. Prof. Franco Battaglia, a professor of environmental chemistry at the University of Modena, and Prof. Gianni Fochi, professor of chemistry at the Scuola Normale Superiore di Pisa, have drawn up a document regarding a depth study of non-stick material, which **certify the absolute eligibility of non-stick coatings materials in terms of food security and environmental protection**.

For more information, visit www.guardini.com





230°C
MAX

Temperatura
Temperature
Température



Antiaderenza
Non-stick
Antiadhérence



Strati antiaderente
Non-stick layers
Couches antiadhésives



Resistenza ai graffi
Scratch resistance
Résistance aux rayures



Garanzia*
Warranty*
Garantie*

Guardini



XBake



MORE INFO



È la nuova collezione di stampi da forno con **ridotto impatto ambientale**. Gli stampi da forno della linea XBake sono realizzati con un acciaio di supporto prodotto da **ArcelorMittal** proveniente da stabilimenti trasformati con tecnologie a **ridotta emissione di CO₂**, e per questo dotato del **"XCarb® green steel certificate"**, un marchio registrato da ArcelorMittal, che rappresenta il percorso intrapreso verso la **decarbonizzazione del processo produttivo dell'industria siderurgica**, contribuendo in modo significativo alla **riduzione delle emissioni di CO₂ in atmosfera**.

Il rivestimento antiaderente della collezione XBake è **privo di PTFE e di PFAS** ed è **rinforzato con particelle ceramiche**.

XBake rappresenta un'azione concreta di Guardini e della sua supply chain verso la **riduzione dell'impatto ambientale**.

*It is the new bakeware collection with a **reduced environmental impact**. The XBake moulds are made of a support steel provided by **ArcelorMittal** and coming from production processes transformed thanks to **sustainable innovative technologies** and therefore equipped with an **XCarb® green steel certificate**, a trademark registered by ArcelorMittal, which represents the path taken towards the **decarbonisation of the steel industry production process**, contributing significantly to the **reduction of the CO₂ emissions in the atmosphere**. The non-stick coating of the XBake collection is **PTFE and PFAS-free and it is reinforced with ceramic particles**.*

*XBake represents a concrete action of Guardini and its supply chain towards the **reduction of the environmental impact**.*



VISTA FRONTE - FRONT VIEW

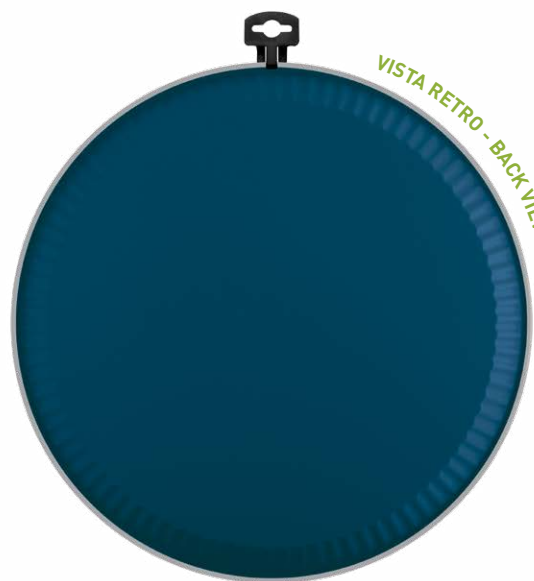

VISTA RETRO - BACK VIEW



MADE in ITALY

Tortiera apribile 2 fondi

Springform 2 bases
Moule démontable 2 fonds
Springform+Rohrboden
Molde desmontable 2 fondos

 Speciale fondo salvagoccia
Leakproof base



CODE	CM	H CM	PACK	EAN
10026SGPBSGNAM	ø 26	7,7	6	8006043 019704

Confezione: etichetta con gancio / Packaging: label with hook hang tag



Tortiera apribile 1 fondo

Springform 1 base
Moule démontable 1 fond
Springform
Molde desmontable 1 fondo



CODE	CM	H CM	PACK	EAN
10118PBSGNAM	ø 18	6,4	6	8006043 019711
10120PBSGNAM	ø 20	6,3	6	8006043 019728

Confezione: etichetta con gancio / Packaging: label with hook hang tag

Tortiera apribile 1 fondo

Springform 1 base
Moule démontable 1 fond
Springform
Molde desmontable 1 fondo



CODE	CM	H CM	PACK	EAN
10122PBSGNAM	ø 22	6,7	6	8006043 019735

Confezione: etichetta con gancio / Packaging: label with hook hang tag

Tortiera apribile 1 fondo

Springform 1 base
Moule à charnière carré
Springform
Molde desmontable 1 fondo

 Speciale fondo salvagoccia
Leakproof base



CODE	CM	H CM	PACK	EAN
10124SGPBSGNAM	ø 24	7,6	6	8006043 019742
10126SGPBSGNAM	ø 26	7,6	6	8006043 019759

Confezione: etichetta con gancio / Packaging: label with hook hang tag

Stampo apribile quadrato

Square springform
Moule à charnière carré
Springform quadratisch
Molde desmontable cuadrado

 Speciale fondo salvagoccia
Leakproof base



CODE	CM	H CM	PACK	EAN
14524PBSAPRGNAM	24 x 24	7	6	8006043 019766

Confezione: etichetta con gancio / Packaging: label with hook hang tag

Stampo apribile rettangolare

Rectangle cake pan
Moule à charnière rectangulaire
Springform rechteckig
Molde desmontable rectangular

 Speciale fondo salvagoccia
Leakproof base



CODE	CM	H CM	PACK	EAN
13519PBSAPRGNAM	19 x 28	7	6	8006043 019773

Confezione: etichetta con gancio / Packaging: label with hook hang tag

Stampo apribile per plumcake

Loaf springform pan
Moule à charnière rectangulaire
Springform Königsuchen
Molde desmontable para plumcake

 Speciale fondo salvagoccia
Leakproof base



CODE	CM	H CM	PACK	EAN
13030PBSAPRGNAM	30 x 11	7	6	8006043 019780

Confezione: etichetta con gancio / Packaging: label with hook hang tag

Tortiera liscia

Round cake tin
Moule à clafoutis
Kuchenform
Molde alto



CODE	CM	H CM	PACK	EAN
10426PBSGNAM	ø 26	5,2	6	8006043 019797

Confezione: etichetta con gancio / Packaging: label with hook hang tag

Stampo crostata

Flan tin
Moule à tarte
Obsttortenboden
Molde rizado



CODE	CM	H CM	PACK	EAN
11028FPPBSGNAM	ø 28	4	6	8006043 019803

Confezione: etichetta con gancio / Packaging: label with hook hang tag

Stampo ciambella

Savarin cake pan
Moule à savarin
Kranzform
Molde savarin



CODE	CM	H CM	PACK	EAN
11525PBSGNAM	ø 25	8	6	8006043 019810

Confezione: etichetta con gancio / Packaging: label with hook hang tag

Stampo budino con cono

Bundtform
Kugelhupf
Gugelhupf
Flanera con cono



CODE	CM	H CM	PACK	EAN
12123PBSEE	ø 23	12	6	8006043 019827

Confezione: etichetta / Packaging: label

Tegame pizza

Pizza tin
Plaque à pizza
Pizzaform
Molde para pizza



CODE	CM	H CM	PACK	EAN
12532PBSGNAM	ø 32	1,5	6	8006043 019834

Confezione: etichetta con gancio / Packaging: label with hook hang tag

Stampo plumcake

Loaf tin
Moule à cake
Königskuchenform
Molde plumcake



CODE	CM	H CM	PACK	EAN
13025PBSGNAM	25 x 11	6,4	6	8006043 019841

Confezione: etichetta con gancio / Packaging: label with hook hang tag

Teglia rettangolare

Baking sheet
Plaque à four rectangulaire
Herbackblech
Bandeja rectangular



CODE	CM	H CM	PACK	EAN
13526PBSGNAM	26 x 37	2,1	6	8006043 019858

Confezione: etichetta con gancio / Packaging: label with hook hang tag

Lasagnera

Bake & roast pan
Plat à four
Auflaufform
Rustidera



CODE	CM	H CM	PACK	EAN
14022PBSGNAM	22 x 28	4,7	6	8006043 019865
14024PBSGNAM	24 x 32	4,7	6	8006043 019872

Confezione: etichetta con gancio / Packaging: label with hook hang tag

Stampo 12 muffins

12 Muffins tray
Plaque à 12 muffins
12 Muffinform
Molde muffin 12 pzas



CODE	CM	H CM	PACK	EAN
14912PBBSGNAM	27 x 35	3	6	8006043 019889

Confezione: etichetta con gancio / Packaging: label with hook hang tag

XBake è il frutto della preziosa collaborazione lungo la filiera produttiva, tra partners con la stessa visione e lo stesso obiettivo: realizzare una collezione di stampi da forno con un ridotto impatto sull'ambiente, a testimonianza del fatto che unendo le forze lungo la filiera si può davvero diventare più sostenibili. Questa collezione è realizzata con un acciaio di supporto prodotto da ArcelorMittal e proveniente da processi produttivi trasformati grazie a tecnologie innovative sostenibili e per questo dotato di un certificato XCarb®, che ne attesta la ridotta impronta carbonica. Il rivestimento antiaderente di XBake è stato realizzato da ILAG ed è privo di PTFE e PFAS, frutto di una nuova tecnologia che è riuscita ad eliminare questi componenti chimici dal processo produttivo e quindi dall'ambiente.

Lo spessore dell'acciaio è ottimizzato per la forma e l'applicazione per **garantire eccellenti prestazioni di cottura**. In questo modo si evita l'uso eccessivo di acciaio e si **ottimizza il trasferimento di calore, il che porta a un risparmio energetico**. Il processo di produzione è ottimizzato nella resa del materiale e gli scarti di acciaio del processo di produzione vengono riciclati per produrre nuovo acciaio.

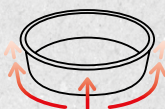

*The thickness of the steel is optimized to the shape and application to **guarantee excellent cooking performance**. In this way, excess use of steel is avoided and heat transfer is **optimized which is leading to energy saving**. The production process is optimized in material yield and steel scrap from the production process is recycled to produce new steel.*

Il **rivestimento antiaderente** è applicato con tecnologia "coil coating" che ne **elimina la dispersione nell'ambiente e garantisce una copertura uniforme** su tutta la superficie dello stampo per **elevate prestazioni antiaderenti** e una **maggiore durata del prodotto**. La **facile pulizia** dello stampo dopo l'uso consente inoltre di **risparmiare acqua e detersivi chimici**.

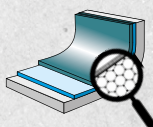

*The **non-stick coating** is applied with "coil coating" technology which **eliminates its dispersion in the environment and guarantees uniform coverage** over the entire surface of the mould for **high non-stick performance** and a **longer product life cycle**. The **easy cleaning** of the mould after use also **saves water and chemical detergents**.*

Il **packaging** del prodotto è rigorosamente **certificato FSC®**, ossia da foreste gestite in modo responsabile.

*The **product packaging** is strictly **FSC® certified**.*



La **produzione degli stampi da forno** è **100% Made in Italy** e proviene da una **filiera di fornitura italiana ed europea**.

*The **baking moulds production** is **100% Made in Italy** and comes from an **Italian and European supply chain**.*



XBake is the result of a fruitful collaboration along the supply chain, between partners with a common purpose: the creation of a baking moulds collection with a reduced impact on the environment. This testifies that by joining forces along the supply chain, we can truly become more sustainable. This collection is made of a support steel provided by ArcelorMittal and coming from production processes transformed thanks to sustainable innovative technologies and therefore equipped with an XCarb® green steel certificate, which certifies its reduced carbon footprint. The XBake non-stick coating was made by ILAG and it is PTFE and PFAS-free, the result of a new technology that has succeeded in eliminating these chemical components from the production process and therefore from the environment.





180°C MAX
 Temperatura
 Temperature
 Température

Antiaderenza
Non-stick
Antiadhérence

2

Strati antiaderente
Non-stick layers
Couches antiadhésives

Resistenza ai graffi
Scratch resistance
Résistance aux rayures

2 ANNI • YEARS • ANNEES
2
Garanzia
Warranty
Garantie

IL 1° RIVESTIMENTO VERAMENTE NATURALE
 Rivestimento alla Cera di Carnauba

 Carnauba Wax coating
 Revêtement à la Cire de Carnauba
1st NATURAL NON-STICK - 1er REVETEMENT NATUREL

FREE
BPA - PFOA
HEALTHY
COATING

Guardini®



Bnat

BAKE NATURAL



MORE INFO



La gamma **B-Nat** è una linea di stampi da forno realizzata in acciaio Hi-Top con rivestimento antiaderente doppio strato Ilaflon Essential a base di **CERA DI CARNAUBA**. Grazie alla **scivolosità** conferita dalla cera di carnauba, il rivestimento risulta così **naturalmente antiaderente**.

The range **B-Nat** is a line of baking moulds made of Hi-Top steel with a Ilaflon Essential double layer non-stick coating with **CARNAUBA WAX**. The carnauba wax gives a **slippery** effect creating a truly **natural non-stick** coating.



La cera di carnauba si ricava dalle foglie della palma *Copernicia prunifera* ed è quindi frutto del naturale processo di cerificazione attuato dalla pianta. La cerificazione è una modificazione che subisce la superficie della foglia per aumentare la propria impermeabilità durante la stagione delle piogge. Questa cera, naturalmente prodotta, viene raccolta durante la stagione secca, sotto forma di scaglie. Ampiamente utilizzata in svariati settori, viene usata nella produzione del rivestimento antiaderente della linea B-Nat, conferendo agli stampi una maggiore lucentezza, per stampi naturalmente antiaderenti.

The Carnauba wax is obtained from the leaves of the *Copernicia prunifera* and it is the result of the natural process of wax production generated by the tree. The wax is produced thanks to the modification of the surface of the leaf to increase its impermeability during the rainy season. This wax, produced naturally, is collected during the dry season in the form of flakes. Widely used in different sectors, it is employed in the production of the non-stick coating of the range B-Nat, giving the moulds more brightness, for naturally non-stick moulds.

Tortiera apribile 2 fondi

Springform 2 bases
Moule démontable 2 fonds
Springform+Rohrboden
Molde desmontable 2 fondos

 Speciale fondo salvagoccia
Leakproof base



CODE	CM	H CM	PACK	EAN
35026CARGNAM	ø 26	7,7	6	8006043 015379

Confezione: etichetta con gancio / Packaging: label with hook hang tag



Tortiera apribile 1 fondo

Springform 1 base
Moule démontable 1 fond
Springform
Molde desmontable 1 fondo



CODE	CM	H CM	PACK	EAN
35122CARGNAM	ø 22	6,7	6	8006043 015331

Confezione: etichetta con gancio / Packaging: label with hook hang tag

Tortiera apribile 1 fondo

Springform 1 base
Moule démontable 1 fond
Springform
Molde desmontable 1 fondo



CODE	CM	H CM	PACK	EAN
35124CARGNAM	ø 24	7,6	6	8006043 015348
35126CARGNAM	ø 26	7,6	6	8006043 015355

Confezione: etichetta con gancio / Packaging: label with hook hang tag

 Speciale fondo salvagoccia
Leakproof base

Tortiera liscia

Round cake tin
Moule à clafoutis
Kuchenform
Molde alto



CODE	CM	H CM	PACK	EAN
35428CARGNAM	ø 28	5,2	6	8006043 015386

Confezione: etichetta con gancio / Packaging: label with hook hang tag

Stampo crostata

Flan tin
Moule à tarte
Obsttortenboden
Molde rizado



CODE	CM	H CM	PACK	EAN
36028FCARGNAM	ø 28	4	6	8006043 015409

Confezione: etichetta con gancio / Packaging: label with hook hang tag

4 crostatine

Set of 4 pie tins
Lot 4 tartelettes
4 Torteletts
Juego de 4 moldes tartaletas



CODE	CM	H CM	PACK	EAN
36204CARVEE	ø 12	1,9	6	8006043 019124

Confezione: fascia in cartoncino appendibile
Packaging: with hangable carton label

Stampo ciambella

Savarin cake pan
Moule à savarin
Kranzform
Molde savarin



CODE	CM	H CM	PACK	EAN
36525CARGNAM	ø 25	8	6	8006043 015416

Confezione: etichetta con gancio / Packaging: label with hook hang tag

Stampo budino con cono

Bundtform
Kugelhupf
Gugelhupf
Flanera con cono



CODE	CM	H CM	PACK	EAN
37123CAREE	ø 23	12	6	8006043 015423

Confezione: etichetta / Packaging: label

Stampo plumcake

Loaf tin
Moule à cake
Königskuchenform
Molde plumcake



CODE	CM	H CM	PACK	EAN
38025CARGNAM	25 x 11	6,4	6	8006043 015430
38030CARGNAM	30 x 11	6,4	6	8006043 015447

Confezione: etichetta con gancio / Packaging: label with hook hang tag

Stampo quadro

Square cake tin
Moule carré
Quadratische Backform
Molde cuadrado



CODE	CM	H CM	PACK	EAN
39524CARGNAM	24 x 24	4,5	6	8006043 015454

Confezione: etichetta con gancio / Packaging: label with hook hang tag

Stampo 6 muffins

6 Muffins tray
Plaque à 6 muffins
6 Muffinform
Molde muffin 6 pzas



CODE	CM	H CM	PACK	EAN
39906CARGNAM	18,5 x 27	2,9	6	8006043 019209

Confezione: etichetta con gancio / Packaging: label with hook hang tag

Stampo 12 muffins

12 Muffins tray
Plaque à 12 muffins
12 Muffinform
Molde muffin 12 pzas



CODE	CM	H CM	PACK	EAN
39912CARGNAM	27 x 35	3	6	8006043 015478

Confezione: etichetta con gancio / Packaging: label with hook hang tag

Teglia da forno piatta

Cookie sheet - Plaque à biscuits
Backblech flach - Bandeja para galletas

CODE	CM	H CM	PACK	EAN
38735CARGNAM	35 x 40	0,2	6	8006043 015461

Confezione: etichetta con gancio / Packaging: label with hook hang tag

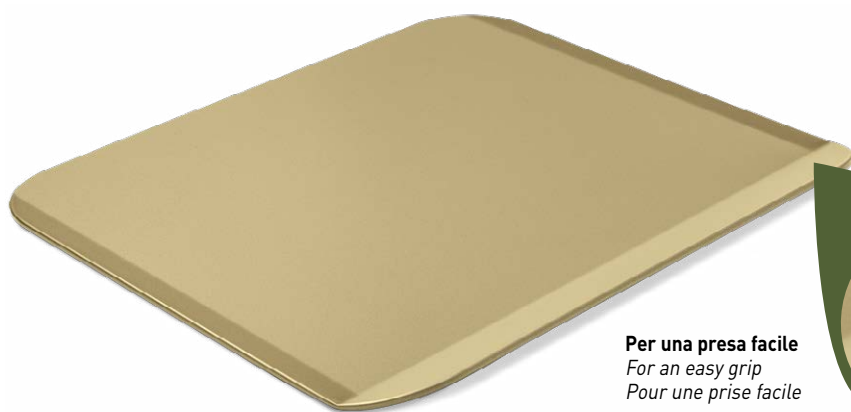

Per una presa facile
For an easy grip
Pour une prise facile

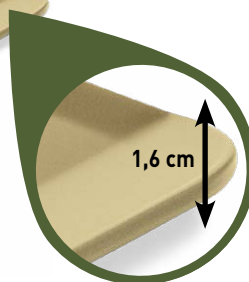

MULTIUSO - MULTIPURPOSE



230°C
MAX

Temperatura
Temperature
Température



Antiaderenza
Non-stick
Antiadhérence



2
Strati antiaderente
Non-stick layers
Couches antiadhésives



Resistenza ai graffi
Scratch resistance
Résistance aux rayures



Garanzia
Warranty
Garantie

+ DUREVOLE
DURABLE
DURABLE

ULTRA-TECH

ELEVATE PRESTAZIONI.
IDEALE PER UN USO INTENSIVO
HIGH PERFORMANCES.
PERFECT FOR INTENSIVE USE
PRESTATIONS ELEVÉES. IDEAL
POUR UNE UTILISATION
INTENSIVE



Guardini®



Gold Elegance



La gamma Gold Elegance è una linea elegante e dalle alte prestazioni, con i suoi colori champagne (per il rivestimento interno antiaderente) e bronzo (per la colorazione esterna).

La linea Gold Elegance è realizzata in acciaio Hi-Top con rivestimento antiaderente interno doppio strato Ilaflon Special. È una linea elegante e dalle alte prestazioni di antiaderenza, resistenza ai graffi e all'usura.

The Gold Elegance range is one of the most stylish, with its combination of external bronze colour and champagne coloured internal non-stick coating.

This line is made of Hi-Top steel with a Ilaflon Special double layer coating. Its elegance is combined with high quality non-stick performances, ease of cooking and cleaning after use.



Gli stampi della linea Gold Elegance sono personalizzati sul fondo dello stampo* con il logo Guardini e la scritta **Made in Italy**, realizzati tramite la tecnologia laser.

*Eccetto lo Stampo ciambella e lo Stampo budino con cono.

The moulds of the Gold Elegance line are customized on the bottom of the mould* with the **Guardini logo** and **Made in Italy**, made using laser technology.

*Except the Savarin cake pan and Bundtform.



Tortiera apribile 2 fondi

Springform 2 bases
Moule démontable 2 fonds
Springform+Rohrboden
Molde desmontable 2 fondos

 Speciale fondo salvagoccia
Leakproof base



CODE	CM	H CM	PACK	EAN
70026GEGNAM	ø 26	7,7	6	8006043 014716

Confezione: etichetta con gancio / Packaging: label with hook hang tag



Tortiera apribile 1 fondo

Springform 1 base
Moule démontable 1 fond
Springform
Molde desmontable 1 fondo

 Speciale fondo salvagoccia
Leakproof base



CODE	CM	H CM	PACK	EAN
70124GEGNAM	ø 24	7,6	6	8006043 015171
70126GEGNAM	ø 26	7,6	6	8006043 014723
70128GEGNAM	ø 28	7,6	6	8006043 015188

Confezione: etichetta con gancio / Packaging: label with hook hang tag

Tortiera liscia

Round cake tin
Moule à clafoutis
Kuchenform
Molde alto



CODE	CM	H CM	PACK	EAN
70428GEGNAM	ø 28	5,2	6	8006043 014730

Confezione: etichetta con gancio / Packaging: label with hook hang tag

Tortiera fiorella

Fiorella cake tin
Moule à manqué
Fiorella kuchenform
Molde Fiorella



CODE	CM	H CM	PACK	EAN
70526GEGNAM	ø 26	6,8	6	8006043 015096

Confezione: etichetta con gancio / Packaging: label with hook hang tag

Stampo crostata

Flan tin
Moule à tarte
Obsttortenboden
Molde rizado



CODE	CM	H CM	PACK	EAN
71028FPGEGNAM	ø 28	4	6	8006043 014747

Confezione: etichetta con gancio / Packaging: label with hook hang tag

Stampo ciambella

Savarin cake pan
Moule à savarin
Kranzform
Molde savarin



CODE	CM	H CM	PACK	EAN
71525GEGNAM	ø 25	8	6	8006043 015102

Confezione: etichetta con gancio / Packaging: label with hook hang tag

Stampo budino con cono

Bundtform
Kugelhupf
Gugelhupf
Flanera con cono



CODE	CM	H CM	PACK	EAN
72123GEEE	ø 23	12	6	8006043 014754

Confezione: etichetta / Packaging: label

Tegame pizza

Pizza tin
Plaque à pizza
Pizzaform
Molde para pizza



CODE	CM	H CM	PACK	EAN
72532GEGNAM	ø 32	1,5	6	8006043 015119

Confezione: etichetta con gancio / Packaging: label with hook hang tag

Stampo plumcake

Loaf tin
Moule à cake
Königskuchenform
Molde plumcake



CODE	CM	H CM	PACK	EAN
73025GEGNAM	25 x 11	6,4	6	8006043 014761

Confezione: etichetta con gancio / Packaging: label with hook hang tag

Teglia rettangolare

Baking sheet
Plaque à four rectangulaire
Herdbackblech
Bandeja rectangular



CODE	CM	H CM	PACK	EAN
73526GEGNAM	26 x 37	2,1	6	8006043 014785

Confezione: etichetta con gancio / Packaging: label with hook hang tag

Lasagnera

Bake & roast pan
Plat à four
Auflaufform
Rustidera



CODE	CM	H CM	PACK	EAN
74024GEGNAM	24 x 32	4,7	6	8006043 014792

Confezione: etichetta con gancio / Packaging: label with hook hang tag

Stampo 12 muffins

12 Muffins tray
Plaque à 12 muffins
12 Muffinform
Molde muffin 12 pzas



CODE	CM	H CM	PACK	EAN
79912GEGNAM	27 x 35	3	6	8006043 014808

Confezione: etichetta con gancio / Packaging: label with hook hang tag





230°C MAX
 Temperatura
 Temperature
 Température

Antiaderenza
 Non-stick
 Antiadhérence

2

 Strati antiaderente
 Non-stick layers
 Couches antiadhésives

Resistenza ai graffi
 Scratch resistance
 Résistance aux rayures

3
 ANNI • YEARS • ANNES
Garanzia
 Warranty
 Garantie

+ DUREVOLE
 DURABLE
 DURABLE
ULTRA-TECH
 ELEVATE PRESTAZIONI. IDEALE PER UN USO INTENSIVO.
 HIGH PERFORMANCES. PERFECT FOR INTENSIVE USE.
 PRESTATIONS ELEVÉES. IDEAL POUR UNE UTILISATION INTENSIVE.

FREE
 BPA - PFOA
HEALTHY COATING

Guardini®



Silver Elegance



La linea **Silver Elegance** è una linea di stampi da forno **realizzata in acciaio con rivestimento antiaderente interno doppio strato Itaflon Special** di color argento. È una linea elegante e dalle alte prestazioni.

The **Silver Elegance** range is one of the most stylish, with its combination of **external black coating and internal double layer Itaflon Special** silver coating. Such elegance is combined with high quality non-stick performances.



VISTA FRONTE - FRONT VIEW



VISTA RETRO - BACK VIEW

Gli stampi della linea Silver Elegance sono personalizzati sul fondo dello stampo* con il **logo Guardini** e la scritta **Made in Italy**, realizzati tramite la tecnologia **laser**.

*Eccetto lo Stampo ciambella e lo Stampo budino con cono.

The moulds of the Silver Elegance line are customized on the bottom of the mould* with the **Guardini logo** and **Made in Italy**, made using **laser technology**.

*Except the Savarin cake pan and Bundtform.



Tortiera apribile 2 fondi

Springform 2 bases
Moule démontable 2 fonds
Springform+Rohrboden
Molde desmontable 2 fondos

 Speciale fondo salvagoccia
Leakproof base



CODE	CM	H CM	PACK	EAN
70026SEGNAM	ø 26	7,7	6	8006043 002317

Confezione: etichetta con gancio / Packaging: label with hook hang tag



Tortiera apribile 1 fondo

Springform 1 base
Moule démontable 1 fond
Springform
Molde desmontable 1 fondo

NEW



CODE	CM	H CM	PACK	EAN
70122SEGNAM	ø 22	6,7	6	8006043 019629

Confezione: etichetta con gancio / Packaging: label with hook hang tag

Tortiera apribile 1 fondo

Springform 1 base
Moule démontable 1 fond
Springform
Molde desmontable 1 fondo

 Speciale fondo salvagoccia
Leakproof base



CODE	CM	H CM	PACK	EAN
70124SEGNAM	ø 24	7,6	6	8006043 002324
70126SEGNAM	ø 26	7,6	6	8006043 002331
70128SEGNAM	ø 28	7,6	6	8006043 003208

Confezione: etichetta con gancio / Packaging: label with hook hang tag

Tortiera liscia

Round cake tin
Moule à clafoutis
Kuchenform
Molde alto



CODE	CM	H CM	PACK	EAN
70428SEGNAM	ø 28	5,2	6	8006043 002379

Confezione: etichetta con gancio / Packaging: label with hook hang tag

Stampo crostata

Flan tin
Moule à tarte
Obsttortenboden
Molde rizado



CODE	CM	H CM	PACK	EAN
71028FPSEGNAM	ø 28	4	6	8006043 002348

Confezione: etichetta con gancio / Packaging: label with hook hang tag

4 crostatine

Set of 4 pie tins
Lot 4 tartelettes
4 Torteletts
Juego de 4 moldes tartaletas



CODE	CM	H CM	PACK	EAN
71204SEVEE	ø 12	1,9	6	8006043 003062

Confezione: fascia in cartoncino appendibile
Packaging: with hangable carton label

Stampo ciambella

Savarin cake pan
Moule à savarin
Kranzform
Molde savarin



CODE	CM	H CM	PACK	EAN
71525SEGNAM	ø 25	8	6	8006043 002409

Confezione: etichetta con gancio / Packaging: label with hook hang tag

Stampo budino con cono

Bundtform
Kugelhupf
Gugelhupf
Flanera con cono



CODE	CM	H CM	PACK	EAN
72123SEEE	ø 23	12	6	8006043 012521

Confezione: etichetta / Packaging: label

Tegame pizza

Pizza tin
Plaque à pizza
Pizzaform
Molde para pizza



CODE	CM	H CM	PACK	EAN
72532SEGNAM	ø 32	1,5	6	8006043 002393

Confezione: etichetta con gancio / Packaging: label with hook hang tag

Tegame pizza surgelata

Frozen pizza tin
Plaque à pizza surgelée
Pizzaform
Molde para pizza congelada



CODE	CM	H CM	PACK	EAN
72732SEGNAM	ø 32	1,5	6	8006043 014365

Confezione: etichetta con gancio / Packaging: label with hook hang tag

Stampo plumcake

Loaf tin
Moule à cake
Königskuchenform
Molde plumcake



CODE	CM	H CM	PACK	EAN
73025SEGNAM	25 x 11	6,4	6	8006043 002355
73030SEGNAM	30 x 11	6,4	6	8006043 003215

Confezione: etichetta con gancio / Packaging: label with hook hang tag

Teglia rettangolare

Baking sheet
Plaque à four rectangulaire
Herdbackblech
Bandeja rectangular



CODE	CM	H CM	PACK	EAN
73526SEGNAM	26 x 37	2,1	6	8006043 002416
73532SEGNAM	32 x 37	2,1	6	8006043 003222

Confezione: etichetta con gancio / Packaging: label with hook hang tag

Lasagnera

Bake & roast pan
Plat à four
Auflaufform
Rustidera



CODE	CM	H CM	PACK	EAN
74022SEGNAM	22 x 28	4,7	6	8006043 003079
74024SEGNAM	24 x 32	4,7	6	8006043 002423

Confezione: etichetta con gancio / Packaging: label with hook hang tag

Stampo quadro

Square cake tin
Moule carré
Quadratische Backform
Molde cuadrado



CODE	CM	H CM	PACK	EAN
74524SEGNAM	24 x 24	4,5	6	8006043 014389

Confezione: etichetta con gancio / Packaging: label with hook hang tag

Stampo 12 muffins

12 Muffins tray
Plaque à 12 muffins
12 Muffinform
Molde muffin 12 pzas



CODE	CM	H CM	PACK	EAN
79912SEGNAM	27 x 35	3	6	8006043 002362

Confezione: etichetta con gancio / Packaging: label with hook hang tag

Teglia da forno piatta

Cookie sheet - Plaque à biscuits

Backblech flach - Bandeja para galletas

CODE	CM	H CM	PACK	EAN
73735SEGNAM	35 x 40	0,2	6	8006043 019131

Confezione: etichetta con gancio / Packaging: label with hook hang tag





**230°C
MAX**

Temperatura
Temperature
Température



Antiaderenza
Non-stick
Antiadhérence



Strati antiaderente
Non-stick layers
Couches antiadhésives



Resistenza ai graffi
Scratch resistance
Résistance aux rayures



Garanzia
Warranty
Garantie



Guardini®



Arianna



Un'ampia e diversificata gamma di stampi da forno, per cucinare con calore e fantasia dolci, pizze, arrostiti e lasagne, arricchendo i momenti trascorsi in famiglia o con gli amici di allegria e convivialità.

Realizzata in acciaio Hi-Top con rivestimento antiaderente Skandia Xtreme Plus doppio strato, la linea Arianna rappresenta la tradizione di casa Guardini. Eccellenti caratteristiche di antiaderenza e di conducibilità termica, fanno di questa linea un'ottima soluzione per ottenere risultati perfetti di cottura e di sfornabilità. Il rivestimento antiaderente di qualità, studiato appositamente per gli stampi da forno, garantisce la facile sfornatura del dolce e la totale pulizia dello stampo dopo l'uso.

A wide and miscellaneous bakeware range for baking desserts, pizza, lasagna, roasts with love and creativity, to enjoy spending time with family and friends.

Made of Hi-Top steel with a Skandia Xtreme Plus double layer coating, the Arianna range represents the Guardini tradition. Excellent non-stick and thermal conductivity properties, make this line a great way to obtain perfect cooking and food release. The quality of non-stick coating, specially studied for bakeware, ensures an easy food release and cleanup.



VISTA FRONTE - FRONT VIEW



VISTA RETRO - BACK VIEW

Ricetta sul retro
Recipe on the back



MADE in ITALY

Tortiera apribile 2 fondi

Springform 2 bases
Moule démontable 2 fonds
Springform+Rohrboden
Molde desmontable 2 fondos

 Speciale fondo salvagoccia
Leakproof base



CODE	CM	H CM	PACK	EAN
55024	ø 24	7,7	6	8006043 550245
55026	ø 26	7,7	6	8006043 550269
55028	ø 28	7,7	6	8006043 550283

Confezione: fascia in cartoncino con gancio
Packaging: carton sleeve with hook hang tag



Tortiera apribile 1 fondo

Springform 1 base
Moule démontable 1 fond
Springform
Molde desmontable 1 fondo

 Speciale fondo salvagoccia
Leakproof base



CODE	CM	H CM	PACK	EAN
55124	ø 24	7,6	6	8006043 551242
55126	ø 26	7,6	6	8006043 551266
55128	ø 28	7,6	6	8006043 551280

Confezione: fascia in cartoncino con gancio
Packaging: carton sleeve with hook hang tag

Tortiera liscia

Round cake tin
Moule à clafoutis
Kuchenform
Molde alto



CODE	CM	H CM	PACK	EAN
55428	ø 28	5,2	6	8006043 554281

Confezione: fascia in cartoncino con gancio
Packaging: carton sleeve with hook hang tag

Tortiera fiorella

Fiorella cake tin
Moule à manqué
Fiorella kuchenform
Molde Fiorella



CODE	CM	H CM	PACK	EAN
55526	ø 26	6,8	6	8006043 555264

Confezione: fascia in cartoncino con gancio
Packaging: carton sleeve with hook hang tag

Stampo cuore

Heart shaped cake tin
Moule à coeur
Herzorten boden
Molde corazón



CODE	CM	H CM	PACK	EAN
55800	25 x 25	4,4	6	8006043 558005

Confezione: fascia in cartoncino con gancio
Packaging: carton sleeve with hook hang tag

Stampo crostata

Flan tin
Moule à tarte
Obsttortenboden
Molde rizado



CODE	CM	H CM	PACK	EAN
56028FP	ø 28	4	6	8006043 560282

Confezione: fascia in cartoncino con gancio
Packaging: carton sleeve with hook hang tag

4 crostatine

Set of 4 pie tins
Lot 4 tartelettes
4 Torteletts
Juego de 4 moldes tartaletas



CODE	CM	H CM	PACK	EAN
56204	ø 12	1,9	6	8006043 562040

Confezione: fascia in cartoncino appendibile
Packaging: with hangable carton label

Stampo ciambella

Savarin cake pan
Moule à savarin
Kranzform
Molde savarin



CODE	CM	H CM	PACK	EAN
56525	ø 25	8	6	8006043 565256

Confezione: fascia in cartoncino con gancio
Packaging: carton sleeve with hook hang tag

Tegame pizza

Pizza tin
Plaque à pizza
Pizzaform
Molde para pizza



CODE	CM	H CM	PACK	EAN
57528	ø 28	1,5	6	8006043 575286
57532	ø 32	1,5	6	8006043 575323

Confezione: fascia in cartoncino con gancio
Packaging: carton sleeve with hook hang tag

Stampo plumcake

Loaf tin
Moule à cake
Königskuchenform
Molde plumcake



CODE	CM	H CM	PACK	EAN
58025	25 x 11	6,4	6	8006043 580259
58030	30 x 11	6,4	6	8006043 580303

Confezione: fascia in cartoncino con gancio
Packaging: carton sleeve with hook hang tag

Teglia rettangolare

Baking sheet
Plaque à four rectangulaire
Herbackblech
Bandeja rectangular



CODE	CM	H CM	PACK	EAN
58526	26 x 37	2,1	6	8006043 585261
58532	32 x 37	2,1	6	8006043 585322

Confezione: fascia in cartoncino con gancio
Packaging: carton sleeve with hook hang tag

Lasagnera

Bake & roast pan
Plat à four
Auflaufform
Rustidera



CODE	CM	H CM	PACK	EAN
59022	22 x 28	4,7	6	8006043 590227
59024	24 x 32	4,7	6	8006043 590241

Confezione: fascia in cartoncino con gancio
Packaging: carton sleeve with hook hang tag

Stampo quadro

Square cake tin
Moule carré
Quadratische Backform
Molde cuadrado



CODE	CM	H CM	PACK	EAN
59524	24 x 24	4,5	6	8006043 595246

Confezione: fascia in cartoncino con gancio
Packaging: carton sleeve with hook hang tag

Stampo 12 muffins

12 Muffins tray
Plaque à 12 muffins
12 Muffinform
Molde muffin 12 pzas



CODE	CM	H CM	PACK	EAN
59912	27 x 35	3	6	8006043 599121

Confezione: fascia in cartoncino con gancio
Packaging: carton sleeve with hook hang tag



230°C
MAX

Temperatura
Temperature
Température



Antiaderenza
Non-stick
Antiadhérence



Strati antiaderente
Non-stick layers
Couches antiadhésives



Resistenza ai graffi
Scratch resistance
Résistance aux rayures



Garanzia
Warranty
Garantie

FACILE DA PULIRE
EASY TO CLEAN
FACILE A NETTOYER

NON-STICK PRO

COTTURA SANA - NO GRASSI
HEALTHY BAKING - NO FATS
CUISINE SAINE
PAS DE GRAISSES

FREE
BPA - PFOA
HEALTHY
COATING

Guardini



GARDENIA



Con una straordinaria vastità di gamma, la linea Gardenia offre alla fantasia del consumatore mille modi di esprimersi.

Realizzata in acciaio Hi-Top, con rivestimento antiaderente Skandia Xtreme Plus doppio strato, la linea Gardenia garantisce risultati perfetti di cottura ed antiaderenza.

La particolare conducibilità termica dell'acciaio utilizzato garantisce cotture in forno rapide ed uniformi di cibi dolci e salati. Il rivestimento antiaderente Skandia Xtreme Plus doppio strato, appositamente studiato per gli stampi da forno, assicura la facile sformatura del dolce e la totale pulizia dello stampo dopo l'uso.

The Gardenia range offers the customers a thousand ways to be creative in the kitchen, thanks to a huge variety of shapes.

Made of Hi-Top steel with Skandia Xtreme Plus double layer coating, the Gardenia line ensures the perfect non-sticking results. The excellent thermal conductivity of the steel ensures rapid and equable cooking of sweet and savoury recipes.

The non-stick coating, specially studied for bakeware, makes the food release and the cleanup easy.

VISTA FRONTE - FRONT VIEW



VISTA RETRO - BACK VIEW



MADE in ITALY

Tortiera apribile 2 fondi

Springform 2 bases
Moule démontable 2 fonds
Springform+Rohrboden
Molde desmontable 2 fondos



CODE	CM	H CM	PACK	EAN
85012EE	ø 12	4,3	6	8006043 010954
85016EF	ø 16	4,7	4	8006043 010961

Confezione: etichetta / Packaging: label

You Tube



Tortiera apribile 2 fondi

Springform 2 bases
Moule démontable 2 fonds
Springform+Rohrboden
Molde desmontable 2 fondos



Speciale fondo salvagoccia
Leakproof base

CODE	CM	H CM	PACK	EAN
85024E	ø 24	7,7	6	8006043 850246
85026E	ø 26	7,7	6	8006043 850260
85028E	ø 28	7,7	6	8006043 850284

Confezione: etichetta / Packaging: label

You Tube



Tortiera apribile 2 fondi

Springform 2 bases
Moule démontable 2 fonds
Springform+Rohrboden
Molde desmontable 2 fondos



CODE	CM	H CM	PACK	EAN
85030E	ø 30	7,7	6	8006043 850307

Confezione: etichetta / Packaging: label

You Tube



Tortiera apribile 1 fondo

Springform 1 base
Moule démontable 1 fond
Springform
Molde desmontable 1 fondo



CODE	CM	H CM	PACK	EAN
85112NEE	ø 12	4,2	6	8006043 010978
85116NEE	ø 16	4,3	6	8006043 010985
85118NEE	ø 18	6,4	6	8006043 017250
85120NEE	ø 20	6,3	6	8006043 010992

Confezione: etichetta / Packaging: label

Tortiera apribile 1 fondo

Springform 1 base
Moule démontable 1 fond
Springform
Molde desmontable 1 fondo



CODE	CM	H CM	PACK	EAN
85120FAEE	ø 20	8,5	6	8006043 018592

Confezione: etichetta / Packaging: label



BORDO ALTO
EXTRA HIGH RING
REBORD TRES HAUT

Tortiera apribile 1 fondo

Springform 1 base
Moule démontable 1 fond
Springform
Molde desmontable 1 fondo



CODE	CM	H CM	PACK	EAN
85122E	ø 22	6,7	6	8006043 851229

Confezione: etichetta / Packaging: label

Tortiera apribile 1 fondo

Springform 1 base
Moule démontable 1 fond
Springform
Molde desmontable 1 fondo



CODE	CM	H CM	PACK	EAN
85124E	ø 24	7,6	6	8006043 851243
85126E	ø 26	7,6	6	8006043 851267
85128E	ø 28	7,6	6	8006043 851281

Confezione: etichetta / Packaging: label

 **Speciale fondo salvagoccia**
Leakproof base

Tortiera apribile 1 fondo

Springform 1 base
Moule démontable 1 fond
Springform
Molde desmontable 1 fondo



CODE	CM	H CM	PACK	EAN
85130E	ø 30	7,6	6	8006043 851304

Confezione: etichetta / Packaging: label

Stampo apribile quadrato

Square springform
Moule à charnière carré
Springform quadratisch
Molde desmontable cuadrado



CODE	CM	H CM	PACK	EAN
89524APREE	24 x 24	7	6	8006043 015256

Confezione: etichetta / Packaging: label

 **Speciale fondo salvagoccia**
Leakproof base

Stampo apribile rettangolare

Rectangle cake pan
Moule à charnière rectangulaire
Springform rechteckig
Molde desmontable rectangular



CODE	CM	H CM	PACK	EAN
88519APREE	19 x 28	7	6	8006043 015263

Confezione: etichetta / Packaging: label

 **Speciale fondo salvagoccia**
Leakproof base

Stampo apribile per plumcake

Loaf springform pan
Moule à charnière rectangulaire
Springform Königs-kuchen
Molde desmontable para plumcake



 Speciale fondo salvagoccia
Leakproof base

CODE	CM	H CM	PACK	EAN
88030APREE	30 x 11	7	6	8006043 015270

Confezione: etichetta / Packaging: label

Tortiera liscia

Round cake tin
Moule à clafoutis
Kuchenform
Molde alto



CODE	CM	H CM	PACK	EAN
85426EE	ø 26	5,2	6	8006043 019148
85428EE	ø 28	5,2	6	8006043 854282
85432EE	ø 32	5,2	6	8006043 012705

Confezione: etichetta / Packaging: label

Tortiera fiorella

Fiorella cake tin
Moule à manqué
Fiorella kuchenform
Molde Fiorella



CODE	CM	H CM	PACK	EAN
85526EE	ø 26	6,8	6	8006043 855265

Confezione: etichetta / Packaging: label

Tortiera fiorella con cono

Savarin cake tin
Moule à savarin
Briocheform
Molde Fiorella con cono



CODE	CM	H CM	PACK	EAN
85626EE	ø 26	7,9	6	8006043 856262

Confezione: etichetta / Packaging: label

Stampo cuore

Heart shaped cake tin
Moule à coeur
Herz-torten boden
Molde corazón



CODE	CM	H CM	PACK	EAN
85800EE	25 x 25	4,4	6	8006043 858006

Confezione: etichetta / Packaging: label

Stampo crostata

Flan tin
Moule à tarte
Obsttortenboden
Molde rizado



CODE	CM	H CM	PACK	EAN
86024FPEE	ø 24	4	6	8006043 860245
86028FPEE	ø 28	4	6	8006043 860283

Confezione: etichetta / Packaging: label

Stampo per crostata morbida

Tart pan for soft cakes
Moule pour gâteaux moelleux
Obstkuchenform
Molde para tartas de fruta



CODE	CM	H CM	PACK	EAN
86028EE	ø 28	4	6	8006043 015294

Confezione: etichetta / Packaging: label



Stampo crostata con fondo smontabile

Loose base flan tin
Moule à tarte avec fond amovible
Obsttorten mit abnehmbar boden
Molde rizado móvil



CODE	CM	H CM	PACK	EAN
86128EE	ø 28	4	6	8006043 861280

Confezione: etichetta / Packaging: label



4 crostatine

Set of 4 pie tins
Lot 4 tartelettes
4 Tortelettes
Juego de 4 moldes tartaletas



CODE	CM	H CM	PACK	EAN
86204EE	ø 12	1,9	6	8006043 862041

Confezione: fascia in cartoncino appendibile / Packaging: with hangable carton label

Stampo ciambella

Savarin cake pan
Moule à savarin
Kranzform
Molde savarin



CODE	CM	H CM	PACK	EAN
86525EE	ø 25	8	6	8006043 865257

Confezione: etichetta / Packaging: label

Stampo budino

Brioche tin
Moule à brioche
Briocheform
Flanera rizada



CODE	CM	H CM	PACK	EAN
87022EE	ø 22	9,3	6	8006043 870220

Confezione: etichetta / Packaging: label

Stampo budino con cono

Bundtform
Kugelhupf
Gugelhupf
Flanera con cono



CODE	CM	H CM	PACK	EAN
87123EE	ø 23	12	6	8006043 872231

Confezione: etichetta / Packaging: label

Tegame pizza

Pizza tin
Plaque à pizza
Pizzaform
Molde para pizza



CODE	CM	H CM	PACK	EAN
87528EE	ø 28	1,5	6	8006043 875287
87532EE	ø 32	1,5	6	8006043 875324

Confezione: etichetta / Packaging: label

Tegame pizza

Pizza tin
Plaque à pizza
Pizzaform
Molde para pizza



CODE	CM	H CM	PACK	EAN
87537EE	ø 37	3	6	8006043 016543

Confezione: etichetta / Packaging: label

Stampo plumcake

Loaf tin
Moule à cake
Königskuchenform
Molde plumcake



CODE	CM	H CM	PACK	EAN
88020EE	21 x 10	5,9	6	8006043 880205

Confezione: etichetta / Packaging: label

Stampo plumcake

Loaf tin
Moule à cake
Königskuchenform
Molde plumcake



CODE	CM	H CM	PACK	EAN
88025EE	25 x 11	6,4	6	8006043 880250
88030EE	30 x 11	6,4	6	8006043 880304

Confezione: etichetta / Packaging: label

Teglia rettangolare

Baking sheet
Plaque à four rectangulaire
Herbackblech
Bandeja rectangular



NEW

CODE	CM	H CM	PACK	EAN
88520EE	31 x 20,5	2,6	6	8006043 019667

Confezione: etichetta / Packaging: label

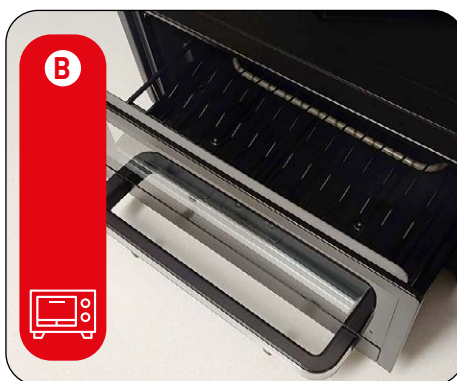

A Ideale per l'uso nella friggitrice ad aria*.
Ideal for use in the air fryer.
Idéal pour une utilisation dans la friteuse à air.
Ideal für den Einsatz in der Heißluftfritteuse.
Ideal para usar en la freidora de aire.

B Ideale per fornetti elettrici*.
Ideal for electric ovens.
Idéal pour les fours électriques.
Ideal für Elektroöfen.
Ideal para hornos eléctricos.

* Previa verifica delle dimensioni interne dell'elettrodomestico
After checking the internal dimensions of the appliance

Teglia rettangolare

Baking sheet
Plaque à four rectangulaire
Herbackblech
Bandeja rectangular



CODE	CM	H CM	PACK	EAN
88526EE	26 x 37	2,1	6	8006043 885262
88532EE	32 x 37	2,1	6	8006043 885323

Confezione: etichetta / Packaging: label

Lasagnera

Bake & roast pan
Plat à four
Auflaufform
Rustidera



CODE	CM	H CM	PACK	EAN
89022EE	22 x 28	4,7	6	8006043 890228
89024EE	24 x 32	4,7	6	8006043 890242
89030EE	30 x 40	5,3	6	8006043 890303

Confezione: etichetta / Packaging: label

Rostiera

Roast pan
Plat à four
Auflaufform
Rustidera



NEW

CODE	CM	H CM	PACK	EAN
88528EE	35 x 27,5	4,5	6	8006043 018905

Confezione: etichetta / Packaging: label

Rostiera con grill

Roast pan with grill rack
Plat à four avec grille
Auflaufform mit Grilleinsatz
Rustidera con parrilla



CODE	CM	H CM	PACK	EAN
89025E	24 x 32	5,3	6	8006043 890259

Confezione: etichetta / Packaging: label

Stampo quadro

Square cake tin
Moule carré
Quadratische Backform
Molde cuadrado



CODE	CM	H CM	PACK	EAN
89524EE	24 x 24	4,5	6	8006043 895247

Confezione: etichetta / Packaging: label

Stampo 6 muffins

6 Muffins tray
Plaque à 6 muffins
6 Muffinform
Molde muffin 6 pzas



CODE	CM	H CM	PACK	EAN
89906EE	18,5 x 27	2,9	6	8006043 899061

Confezione: etichetta / Packaging: label

Stampo 6 muffins + 30 pirottini di carta

6 Muffins tray
+ 30 paper bun cases

Plaque à 6 muffins
+ 30 barquettes papier

6 Muffinform + 30 papierback-förmchen

Molde 6 muffin + 30 moldes pastelito



CODE	CM	H CM	PACK	EAN
89907	18,5 x 27	2,9	12	8006043 899078

Confezione: film termoretrato + etichetta / Packaging: heat-shrunk film + label

Stampo 12 muffins

12 Muffins tray
Plaque à 12 muffins
12 Muffinform
Molde muffin 12 pzas



CODE	CM	H CM	PACK	EAN
89912EE	27 x 35	3	6	8006043 899122

Confezione: etichetta / Packaging: label

Stampo 12 muffins + 60 pirottini di carta

12 Muffins tray
+ 60 paper bun cases

Plaque à 12 muffins
+ 60 barquettes papier

12 Muffinform
+ 60 papierback-förmchen

Molde 12 muffin + 60 moldes pastelito



CODE	CM	H CM	PACK	EAN
89913	27 x 35	3	12	8006043 899139

Confezione: film termoretrato + etichetta / Packaging: heat-shrunk film + label

Teglia rettangolare **estensibile**

Adjustable baking tray - Plaque à four rectangulaire extensible
Ausziehbare Backform - Bandeja rectangular extensible



CODE	CM	H CM	PACK	EAN
88634EE1	33,3 x 38 33,3 x 51,3	3	6	8006043 886344

Confezione: etichetta / Packaging: label



MULTIUSO - MULTIPURPOSE



Teglia da forno piatta

Cookie sheet - Plaque à biscuits
Backblech flach - Bandeja para galletas



Per una presa facile
For an easy grip
Pour une prise facile

CODE	CM	H CM	PACK	EAN
88735EE	35 x 40	0,2	6	8006043 015249

Confezione: etichetta / Packaging: label



MULTIUSO - MULTIPURPOSE





**230°C
MAX**

Temperatura
Temperature
Température



Antiaderenza
Non-stick
Antiadhérence



Strati antiaderente
Non-stick layers
Couches antiadhésives



Resistenza ai graffi
Scratch resistance
Résistance aux rayures



Garanzia
Warranty
Garantie



Guardini®



Bon Ton



La collezione Bon Ton, dai colori tenui e provenzali, è composta da teglie tanto belle da vedere, quanto resistenti e pratiche da usare.

Le numerose forme sono realizzate in acciaio Hi-Top con rivestimento antiaderente doppio strato Skandia Xtreme Plus. Le teglie da forno della linea Bon Ton garantiscono risultati perfetti di cottura ed antiaderenza. Grazie alla particolare conducibilità termica dell'acciaio utilizzato e al suo basso spessore, la cottura in forno di tutti i cibi, dolci e salati, risulta rapida ed uniforme.

Il rivestimento antiaderente di qualità assicura ottimi risultati nella sfornatura del dolce e nella cottura di piatti salati, garantendo inoltre la facilità nella pulizia dello stampo dopo l'uso.

The Bon Ton collection has soft and provençal colours, all baking moulds are so beautiful to see, as strong and practical to use.

Bon Ton moulds are made of Hi-Top steel with a double layer of Skandia Xtreme Plus non-stick coating. Bon Ton moulds ensure perfect baking and non-stick results. The excellent heat distribution and low thickness of the steel allows uniform and rapid baking of any sweet and savoury dish.

The quality non-stick coating ensures excellent results in cooking, food release and cleanup.

VISTA FRONTE - FRONT VIEW



VISTA RETRO - BACK VIEW



Colori / Colors:



PALE GREEN



PINK LILAC



PURPLE LILAC





MADE in ITALY

Tortiera apribile 1 fondo con cono

Springform with tube base
Moule démontable
Springform
Molde desmontable

 Speciale fondo salvagoccia
Leakproof base



CODE	CM	H CM	PACK	EAN
 70226PAGBHEE	ø 26	7,7	6	8006043 016864
 70226PKLBHEE				
 70226PULBHEE				

Confezione: etichetta / Packaging: label

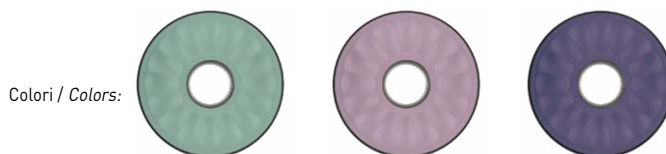



Tortiera apribile 1 fondo

Springform 1 base
Moule démontable 1 fond
Springform
Molde desmontable 1 fondo

 Speciale fondo salvagoccia
Leakproof base



CODE	CM	H CM	PACK	EAN
 70126PAGBHEE	ø 26	7,6	6	8006043 016871
 70126PKLBHEE				
 70126PULBHEE				



Confezione: etichetta / Packaging: label



Tortiera liscia

Round cake tin
Moule à clafoutis
Kuchenform
Molde alto



CODE	CM	H CM	PACK	EAN
 70428PAGBHEE	ø 28	5,2	6	8006043 016888
 70428PKLBHEE				
 70428PULBHEE				



Confezione: etichetta / Packaging: label



Tortiera fiorella

Fiorella cake tin
Moule à manqué
Fiorella kuchenform
Molde Fiorella



CODE	CM	H CM	PACK	EAN
 70526PAGBHEE	ø 26	6,8	6	8006043 016895
 70526PKLBHEE				
 70526PULBHEE				

Confezione: etichetta / Packaging: label



Stampo cuore

Heart shaped cake tin
Moule à coeur
Herzorten boden
Molde corazón



CODE	CM	H CM	PACK	EAN
● 70800PAGBHEE	25 x 25	4,4	6	8006043 016901
● 70800PKLBHEE				
● 70800PULBHEE				

Confezione: etichetta / Packaging: label

Colori / Colors:



Stampo crostata

Flan tin
Moule à tarte
Obsttortenboden
Molde rizado



CODE	CM	H CM	PACK	EAN
● 71028FPAGBHEE	ø 28	4	6	8006043 016918
● 71028FPKLBHEE				
● 71028FPULBHEE				

Confezione: etichetta / Packaging: label

Colori / Colors:



Stampo budino con cono

Bundtform
Kugelhupf
Gugelhupf
Flanera con cono



CODE	CM	H CM	PACK	EAN
● 72123PAGBHEE	ø 23	12	6	8006043 016925
● 72123PKLBHEE				
● 72123PULBHEE				

Confezione: etichetta / Packaging: label

Colori / Colors:



Tegame pizza

Pizza tin
Plaque à pizza
Pizzaform
Molde para pizza



CODE	CM	H CM	PACK	EAN
● 72528PAGBHEE	ø 28	1,5	6	8006043 016970
● 72528PKLBHEE				
● 72528PULBHEE				

Confezione: etichetta / Packaging: label

Colori / Colors:



Stampo plumcake

Loaf tin
Moule à cake
Königskuchenform
Molde plumcake



CODE	CM	H CM	PACK	EAN
● 73025PAGBHEE	25 x 11	6,4	6	8006043 016932
● 73025PKLBHEE				
● 73025PULBHEE				

Confezione: etichetta / Packaging: label

Colori / Colors:



Lasagnera

Bake & roast pan
Plat à four
Auflaufform
Rustidera



CODE	CM	H CM	PACK	EAN
● 74022PAGBHEE	22 x 28	4,7	6	8006043 016949
● 74022PKLBHEE				
● 74022PULBHEE				

Confezione: etichetta / Packaging: label

Colori / Colors:



Stampo quadro

Square cake tin
Moule carré
Quadratische Backform
Molde cuadrado



CODE	CM	H CM	PACK	EAN
● 74524PAGBHEE	24 x 24	4,5	6	8006043 016956
● 74524PKLBHEE				
● 74524PULBHEE				

Confezione: etichetta / Packaging: label

Colori / Colors:



Stampo 12 muffins

12 Muffins tray
Plaque à 12 muffins
12 Muffinform
Molde muffin 12 pzas



CODE	CM	H CM	PACK	EAN
● 74912PAGBHEE	27 x 35	3	6	8006043 016963
● 74912PKLBHEE				
● 74912PULBHEE				

Confezione: etichetta / Packaging: label

Colori / Colors:







**230°C
MAX**

Temperatura
Temperature
Température



Antiaderenza
Non-stick
Antiadhérence



Strati antiaderente
Non-stick layers
Couches antiadhésives



Resistenza ai graffi
Scratch resistance
Résistance aux rayures



Garanzia
Warranty
Garantie



Guardini®



Chocoforme



Chocoforme è una linea di stampi dal doppio colore. Il rivestimento esterno color cioccolato e l'antiaderente color crema all'interno fanno della linea Chocoforme un'ottima idea per creare i propri dolci in stampi da forno assolutamente... golosi.

Realizzati in acciaio Hi-Top con rivestimento antiaderente doppio strato Ilaflon Special, gli stampi da forno della linea Chocoforme garantiscono ottimi risultati di cottura e antiaderenza.

Questo tipo di rivestimento è caratterizzato da ottime proprietà antiaderenti, che ne rendono facile la pulizia dopo l'uso.

Grazie anche alla notevole resistenza alle abrasioni, è consigliato per un uso intensivo e di alto livello.

Chocoforme is a two-tone range of moulds, coated externally with chocolate colour and internally with non-stick cream colour. Chocoforme allows to bake delicious cakes... in delicious tins.

Made of Hi-Top steel with a double layer of Ilaflon Special, Chocoforme moulds ensure perfect baking results and excellent food release. Thanks to the perfect heat distribution of the steel and to its low thickness, the baking performances are increased. This type of coating ensures excellent non-stick properties, ease of cooking and cleaning after use.

Thanks to its abrasion resistance this coating is ideal for intensive use.

VISTA FRONTE - FRONT VIEW



VISTA RETRO - BACK VIEW

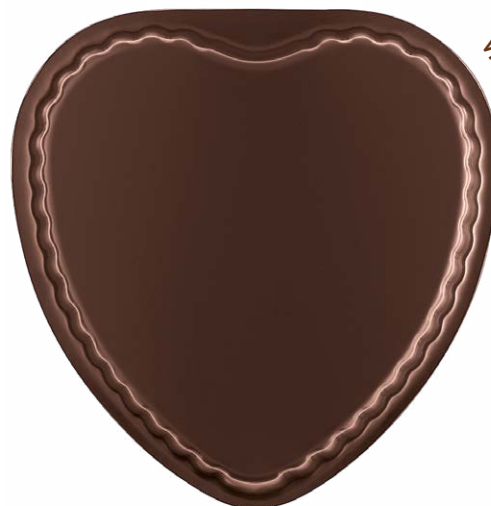

MADE in ITALY

Tortiera apribile 1 fondo

Springform 1 base
Moule démontable 1 fond
Springform
Molde desmontable 1 fondo

 Speciale fondo salvagoccia
Leakproof base



CODE	CM	H CM	PACK	EAN
00701H	ø 26	7,6	6	8006043 000313

Confezione: etichetta / Packaging: label

Tortiera liscia

Round cake tin
Moule à clafoutis
Kuchenform
Molde alto



CODE	CM	H CM	PACK	EAN
00704H	ø 28	5,2	24	8006043 000337

Confezione: etichetta / Packaging: label

Tortiera fiorella

Fiorella cake tin
Moule à manqué
Fiorella kuchenform
Molde Fiorella



CODE	CM	H CM	PACK	EAN
00705H	ø 26	6,8	24	8006043 000344

Confezione: etichetta / Packaging: label

Stampo cuore

Heart shaped cake tin
Moule à coeur
Herzorten boden
Molde corazon



CODE	CM	H CM	PACK	EAN
00708H	25 x 25	4,4	24	8006043 000351

Confezione: etichetta / Packaging: label

Stampo crostata

Flan tin
Moule à tarte
Obsttortenboden
Molde rizado



CODE	CM	H CM	PACK	EAN
00710FPH	ø 28	4	24	8006043 000368

Confezione: etichetta / Packaging: label

Stampo ciambella

Savarin cake pan
Moule à savarin
Kranzform
Molde savarin



CODE	CM	H CM	PACK	EAN
00715H	ø 25	8	24	8006043 000375

Confezione: etichetta / Packaging: label

Stampo budino

Brioche tin
Moule à brioche
Briocheform
Flanera rizada



CODE	CM	H CM	PACK	EAN
00720H	ø 22	9,3	24	8006043 000382

Confezione: etichetta / Packaging: label

Stampo plumcake

Loaf tin
Moule à cake
Königskuchenform
Molde plumcake



CODE	CM	H CM	PACK	EAN
00730H	25 x 11	6,4	24	8006043 000399

Confezione: etichetta / Packaging: label

Teglia rettangolare

Baking sheet
Plaque à four rectangulaire
Herbackblech
Bandeja rectangular



CODE	CM	H CM	PACK	EAN
00735H	26 x 37	2,1	24	8006043 000405

Confezione: etichetta / Packaging: label

Teglia multiuso

Bake & roast pan
Plat à four
Auflaufform
Rustidera



CODE	CM	H CM	PACK	EAN
00740H	22 x 28	4,7	24	8006043 000412

Confezione: etichetta / Packaging: label

Stampo quadro

Square cake tin
Moule carré
Quadratische Backform
Molde cuadrado



CODE	CM	H CM	PACK	EAN
00745H	24 x 24	4,5	24	8006043 000429

Confezione: etichetta / Packaging: label

Stampo 6 muffins

6 Muffins tray
Plaque à 6 muffins
6 Muffinform
Molde muffin 6 pzas



CODE	CM	H CM	PACK	EAN
00748H	18,5 x 27	2,9	24	8006043 006308

Confezione: etichetta / Packaging: label

Stampo 12 muffins

12 Muffins tray
Plaque à 12 muffins
12 Muffinform
Molde muffin 12 pzas



CODE	CM	H CM	PACK	EAN
00749H	27 x 35	3	24	8006043 006315

Confezione: etichetta / Packaging: label

Set 3 stampi da forno

Set of 3 non-stick coating moulds
Lot de 3 moules à gâteaux
anti-adhérents
Backformen-set (3 tlg)
Set 3 moldes en acero antiadherente



CODE	CM	PACK	EAN
00737H	30 x 30 x 13,5	4	8006043 000573

Confezione: scatola / Packaging: box
Per maggiori dettagli: vedi pag. 138 / For more details: see page 138





**230°C
MAX**

Temperatura
Temperature
Température



Antiaderenza
Non-stick
Antiadhérence



Strati antiaderente
Non-stick layers
Couches antiadhésives



Resistenza ai graffi
Scratch resistance
Résistance aux rayures



Garanzia
Warranty
Garantie



Guardini®



HAPPY HOUR



Con un'ampia varietà di forme, la gamma Happy Hour è perfetta per cucinare con allegria grazie alla perfetta antiaderenza del rivestimento.

Realizzati in acciaio Hi-Top con rivestimento antiaderente doppio strato Skandia Xtreme Plus, gli stampi da forno della linea Happy Hour sono il frutto di una ricerca avanzata in tema di rivestimenti antiaderenti e garantiscono risultati perfetti di cottura ed antiaderenza. Il basso spessore dell'acciaio utilizzato consente l'uniforme diffusione del calore, garantendo una cottura rapida e perfetta.

With a wide variety of shapes, the Happy Hour range is perfect for cooking with joy thanks to the perfect non-stick coating.

Made of Hi-Top steel with a double layer Skandia Xtreme Plus non-stick coating, Happy Hour provides perfect baking results and easy food release. The low thickness of the steel allows perfect heat distribution, providing quick and excellent baking results.

VISTA FRONTE - FRONT VIEW



VISTA RETRO - BACK VIEW

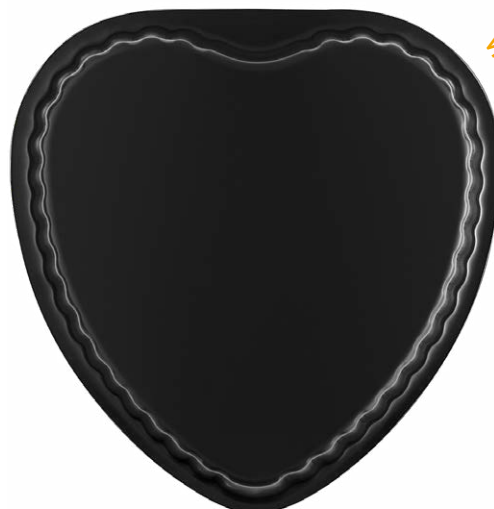

MADE in ITALY

Tortiera apribile 2 fondi

Springform 2 bases
Moule démontable 2 fonds
Springform+Rohrboden
Molde desmontable 2 fondos



CODE	CM	H CM	PACK	EAN
05024HEE	ø 24	6,9	6	8006043 016598
05026HEE	ø 26	6,9	6	8006043 016604
05028HEE	ø 28	6,9	6	8006043 016611

Confezione: etichetta / Packaging: label



Tortiera apribile 1 fondo

Springform 1 base
Moule démontable 1 fond
Springform
Molde desmontable 1 fondo



CODE	CM	H CM	PACK	EAN
05124HEE	ø 24	6,8	6	8006043 016628
05126HEE	ø 26	6,8	6	8006043 016635
05128HEE	ø 28	6,8	6	8006043 016642

Confezione: etichetta / Packaging: label

Tortiera liscia

Round cake tin
Moule à clafoutis
Kuchenform
Molde alto



CODE	CM	H CM	PACK	EAN
05428HEE	ø 28	5,2	6	8006043 016659
05432HEE	ø 32	5,2	6	8006043 016666

Confezione: etichetta / Packaging: label

Tortiera fiorella

Fiorella cake tin
Moule à manqué
Fiorella kuchenform
Molde Fiorella



CODE	CM	H CM	PACK	EAN
05526HEE	ø 26	6,8	6	8006043 016673

Confezione: etichetta / Packaging: label

Tortiera fiorella con cono

Savarin cake tin
Moule à savarin
Briocheform
Molde Fiorella con cono



CODE	CM	H CM	PACK	EAN
05626HEE	ø 26	7,9	6	8006043 016680

Confezione: etichetta / Packaging: label

Stampo cuore

Heart shaped cake tin
Moule à coeur
Herzorten boden
Molde corazón



CODE	CM	H CM	PACK	EAN
05800HEE	25 x 25	4,4	6	8006043 016697

Confezione: etichetta / Packaging: label

Stampo crostata

Flan tin
Moule à tarte
Obsttortenboden
Molde rizado



CODE	CM	H CM	PACK	EAN
06028FPHEE	ø 28	4	6	8006043 016703
06030FPHEE	ø 30	4	6	8006043 016710

Confezione: etichetta / Packaging: label

Stampo ciambella

Savarin cake pan
Moule à savarin
Kranzform
Molde savarin



CODE	CM	H CM	PACK	EAN
06525HEE	ø 25	8	6	8006043 016727

Confezione: etichetta / Packaging: label

Tegame pizza

Pizza tin
Plaque à pizza
Pizzaforn
Molde para pizza



CODE	CM	H CM	PACK	EAN
07528HEE	ø 28	1,5	6	8006043 016734
07532HEE	ø 32	1,5	6	8006043 016741
07537HEE	ø 37	3	6	8006043 016758

Confezione: etichetta / Packaging: label

Stampo plumcake

Loaf tin
Moule à cake
Königskuchenform
Molde plumcake



CODE	CM	H CM	PACK	EAN
08025HEE	25 x 11	6,4	6	8006043 016765
08030HEE	30 x 11	6,4	6	8006043 016772

Confezione: etichetta / Packaging: label

Teglia rettangolare

Baking sheet
Plaque à four rectangulaire
Herbackblech
Bandeja rectangular



CODE	CM	H CM	PACK	EAN
08526HEE	26 x 37	2,1	6	8006043 016789
08532HEE	32 x 37	2,1	6	8006043 016796

Confezione: etichetta / Packaging: label

Lasagnera

Bake & roast pan
Plat à four
Auflaufform
Rustidera



CODE	CM	H CM	PACK	EAN
09022HEE	22 x 28	4,7	6	8006043 016802
09024HEE	24 x 32	4,7	6	8006043 016819
09030HEE	30 x 40	5,3	6	8006043 016826

Confezione: etichetta / Packaging: label

Stampo quadro

Square cake tin
Moule carré
Quadratische Backform
Molde cuadrado



CODE	CM	H CM	PACK	EAN
09524HEE	24 x 24	4,5	6	8006043 016833

Confezione: etichetta / Packaging: label

Stampo 12 muffins

12 Muffins tray
Plaque à 12 muffins
12 Muffinform
Molde muffin 12 pzas



CODE	CM	H CM	PACK	EAN
09912HEE	27 x 35	3	6	8006043 016840

Confezione: etichetta / Packaging: label





**230°C
MAX**

Temperatura
Temperature
Température



Antiaderenza
Non-stick
Antiadhérence



2
Strati antiaderente
Non-stick layers
Couches antiadhésives



Resistenza ai graffi
Scratch resistance
Résistance aux rayures



Garanzia
Warranty
Garantie

SPESSORE
OTTIMIZZATO PER
UNA COTTURA UNIFORME
PERFECT BAKING
OPTIMIZED THICKNESS
FOR UNIFORM COOKING
ÉPAISSEUR OPTIMISÉE
POUR UNE CUISSON
UNIFORME

BPA FREE
HEALTHY
COATING

Guardini®



Rossana



Ampia e colorata gamma di stampi da forno in rosso vivo, la linea Rossana comunica tutta la fantasia e la passione per la cucina al forno. Le numerose forme sono realizzate in acciaio Hi-Top con rivestimento antiaderente doppio strato Skandia Xtreme Plus. Le teglie da forno della linea Rossana garantiscono risultati perfetti di cottura ed antiaderenza. Grazie alla particolare conducibilità termica dell'acciaio utilizzato e al suo basso spessore, la cottura in forno di tutti i cibi, dolci e salati, risulta rapida ed uniforme. Il rivestimento antiaderente di qualità assicura ottimi risultati nella sformatura del dolce e nella cottura di piatti salati, garantendo inoltre la facilità nella pulizia dello stampo dopo l'uso.

A broad colourful range of bakeware in bright red, the Rossana line conveys all the imagination and passion for baking. Rossana moulds are made of Hi-Top steel with a double layer of Skandia Xtreme Plus non-stick coating. They ensure perfect baking and non-stick results. The excellent heat distribution and low thickness of the steel allows uniform and rapid baking of any sweet and savoury dish. The quality non-stick coating ensures excellent results in cooking, food release and cleanup.



MADE in ITALY

Tortiera apribile 2 fondi

Springform 2 bases
Moule démontable 2 fonds
Springform+Rohrboden
Molde desmontable 2 fondos

 Speciale fondo salvagoccia
Leakproof base



CODE	CM	H CM	PACK	EAN
50024HGNAM	ø 24	7,7	6	8006043 016994
50026HGNAM	ø 26	7,7	6	8006043 017007
50028HGNAM	ø 28	7,7	6	8006043 017014

Confezione: etichetta con gancio / Packaging: label with hook hang tag



Tortiera apribile 1 fondo

Springform 1 base
Moule démontable 1 fond
Springform
Molde desmontable 1 fondo

NEW



CODE	CM	H CM	PACK	EAN
50122HGNAM	ø 22	6,7	6	8006043 018370

Confezione: etichetta con gancio / Packaging: label with hook hang tag

Tortiera apribile 1 fondo

Springform 1 base
Moule démontable 1 fond
Springform
Molde desmontable 1 fondo

 Speciale fondo salvagoccia
Leakproof base



CODE	CM	H CM	PACK	EAN
50124HGNAM	ø 24	7,6	6	8006043 017021
50126HGNAM	ø 26	7,6	6	8006043 017038
50128HGNAM	ø 28	7,6	6	8006043 017045

Confezione: etichetta con gancio / Packaging: label with hook hang tag

Tortiera liscia

Round cake tin
Moule à clafoutis
Kuchenform
Molde alto



CODE	CM	H CM	PACK	EAN
50428HGNAM	ø 28	5,2	6	8006043 017052

Confezione: etichetta con gancio / Packaging: label with hook hang tag

Tortiera fiorella

Fiorella cake tin
Moule à manqué
Fiorella kuchenform
Molde Fiorella



CODE	CM	H CM	PACK	EAN
50526HGNAM	ø 26	6,8	6	8006043 017069

Confezione: etichetta con gancio / Packaging: label with hook hang tag

Tortiera fiorella con cono

Savarin cake tin
Moule à savarin
Briocheform
Molde Fiorella con cono



CODE	CM	H CM	PACK	EAN
50626HGNAM	ø 26	7,9	6	8006043 017076

Confezione: etichetta con gancio / Packaging: label with hook hang tag

Stampo cuore

Heart shaped cake tin
Moule à coeur
Herzorten boden
Molde corazón



CODE	CM	H CM	PACK	EAN
50800HGNAM	25 x 25	4,4	6	8006043 017083

Confezione: etichetta con gancio / Packaging: label with hook hang tag

Stampo crostata

Flan tin
Moule à tarte
Obsttortenboden
Molde rizado



CODE	CM	H CM	PACK	EAN
51028FPHGNAM	ø 28	4	6	8006043 017090

Confezione: etichetta con gancio / Packaging: label with hook hang tag

4 crostatine

Set of 4 pie tins
Lot 4 tartelettes
4 Torteletts
Juego de 4 moldes tartaletas



CODE	CM	H CM	PACK	EAN
51204HV	ø 12	1,9	6	8006043 017106

Confezione: fascia in cartoncino appendibile / Packaging: with hangable carton label

Stampo ciambella

Savarin cake pan
Moule à savarin
Kranzform
Molde savarin



CODE	CM	H CM	PACK	EAN
51525HGNAM	ø 25	8	6	8006043 017113

Confezione: etichetta con gancio / Packaging: label with hook hang tag

Stampo budino

Brioche tin
Moule à brioche
Briocheform
Flanera rizada



CODE	CM	H CM	PACK	EAN
52022HGNA	ø 22	9,3	6	8006043 017120

Confezione: etichetta / Packaging: label

Stampo budino con cono

Bundtform
Kugelhupf
Gugelhupf
Flanera con cono



CODE	CM	H CM	PACK	EAN
52123HGNAM	ø 23	12	6	8006043 017137

Confezione: etichetta con gancio / Packaging: label with hook hang tag

Tegame pizza

Pizza tin
Plaque à pizza
Pizzaform
Molde para pizza



CODE	CM	H CM	PACK	EAN
52528HGNAM	ø 28	1,5	6	8006043 017144
52532HGNAM	ø 32	1,5	6	8006043 017151

Confezione: etichetta con gancio / Packaging: label with hook hang tag

Stampo plumcake

Loaf tin
Moule à cake
Königskuchenform
Molde plumcake



CODE	CM	H CM	PACK	EAN
53025HGNAM	25 x 11	6,4	6	8006043 017168
53030HGNAM	30 x 11	6,4	6	8006043 017175

Confezione: etichetta con gancio / Packaging: label with hook hang tag

Teglia rettangolare

Baking sheet
Plaque à four rectangulaire
Herbackblech
Bandeja rectangular



CODE	CM	H CM	PACK	EAN
53526HGNAM	26 x 37	2,1	6	8006043 017182
53532HGNAM	32 x 37	2,1	6	8006043 017199

Confezione: etichetta con gancio / Packaging: label with hook hang tag

Lasagnera

Bake & roast pan
Plat à four
Auflaufform
Rustidera



CODE	CM	H CM	PACK	EAN
54022HG NAM	22 x 28	4,7	6	8006043 017205
54024HG NAM	24 x 32	4,7	6	8006043 017212

Confezione: etichetta con gancio / Packaging: label with hook hang tag

Stampo quadro

Square cake tin
Moule carré
Quadratische Backform
Molde cuadrado



CODE	CM	H CM	PACK	EAN
54524HG NAM	24 x 24	4,5	6	8006043 017229

Confezione: etichetta con gancio / Packaging: label with hook hang tag

Teglia rettangolare **estensibile**

Adjustable baking tray - Plaque à four rectangulaire extensible
Ausziehbare Backform - Bandeja rectangular extensible



CODE	CM	H CM	PACK	EAN
53634HEE	33,3 x 38	3	6	8006043 017236
	33,3 x 51,3			

Confezione: etichetta / Packaging: label



MULTIUSO - MULTIPURPOSE



Teglia da forno piatta

Cookie sheet - Plaque à biscuits
Backblech flach - Bandeja para galletas



Per una presa facile
For an easy grip
Pour une prise facile

CODE	CM	H CM	PACK	EAN
53735HG NAM	35 x 40	0,2	6	8006043 017243

Confezione: etichetta con gancio / Packaging: label with hook hang tag



MULTIUSO - MULTIPURPOSE



**230°C
MAX**

Temperatura
Temperature
Température



Antiaderenza
Non-stick
Antiadhérence



Strati antiaderente
Non-stick layers
Couches antiadhésives



Resistenza ai graffi
Scratch resistance
Résistance aux rayures



Garanzia
Warranty
Garantie



Guardini®



Bake Away



You Tube



Bake Away è una linea di stampi da forno corredati di un coperchio con pratiche maniglie, ideale per trasportare ovunque tutte le preparazioni cotte o da cuocere.

I rivestimenti antiaderenti garantiscono risultati perfetti di cottura e di antiaderenza. La particolare conducibilità termica dell'acciaio utilizzato garantisce cotture in forno rapide ed uniformi di piatti dolci e salati. Il coperchio è realizzato in plastica e consente la chiusura dello stampo. È inoltre dotato di due resistenti manici che ne permettono una facile impugnabilità. **Il coperchio è da utilizzarsi solo per la conservazione delle pietanze in frigorifero e per il trasporto.**

Bake Away is a range of moulds equipped with a convenient carrying lid, which allows you to carry anywhere all your preparations, cooked or to be cooked.

The non-stick coatings ensure excellent cooking results and easy food release. The excellent heat distribution of the steel allows a quick and uniform cooking of sweet and savoury recipes. The lid is made of plastic and clings steadily to the mould, while the two solid handles give a firm grip. **The lid should be used only for storing food in the refrigerator and for transportation.**

VISTA FRONTE - FRONT VIEW



COPERCHIO - LID



CUCINI, CHIUDI, PRENDI E PORTI VIA!
BAKE, CLOSE AND TAKE AWAY!



Pratiche maniglie per il trasporto.
Practical handles for transport.

MADE in ITALY

Tortiera apribile 1 fondo con coperchio per trasporto

Springform 1 base with carrying lid
Moule démontable 1 fond
avec couvercle de transport
Springform mit Transporthaube
Molde desmontable 1 fondo
con tapa transportable



CODE	CM	H CM	PACK	EAN
55126BAK	ø 26	7,6	4	8006043 003468

*Dim. tortiera con coperchio - Size springform with lid: ø 27,8 x H 10,5 cm

Confezione: etichetta adesiva / Packaging: sticker

 Speciale fondo salvagoccia
Leakproof base

Stampo crostata con coperchio per trasporto

Flan tin with carrying lid
Moule à tarte avec couvercle
de transport
Obsttortenboden mit
Transporthaube
Molde rizado con tapa
transportable



CODE	CM	H CM	PACK	EAN
56028FPBAK	ø 28	4	4	8006043 000542

*Dim. crostata con coperchio - Size flan tin with lid: ø 30,7 x H 6,4 cm

Confezione: etichetta adesiva / Packaging: sticker

Stampo da forno con coperchio per trasporto

Baking mould with carrying lid
Plat à four avec couvercle
de transport
Brat-und Backform mit
Transporthaube
Molde de horno con tapa
transportable



CODE	CM	H CM	PACK	EAN
59024BAK	24 x 32	4,7	4	8006043 003161

*Dim. lasagnera con coperchio - Size mould with lid: 27,6 x 37,2 x H 8,5 cm

Confezione: etichetta adesiva / Packaging: sticker

Stampo 12 muffins con coperchio per trasporto

12 Muffins tray with
carrying lid
Plat à 12 Muffins avec
couvercle de transport
12 Muffinform mit
Transporthaube
Molde muffin 12 pzas
con tapa transportable



CODE	CM	H CM	PACK	EAN
59912BAK	27 x 35,5	3	4	8006043 000566

*Dim. stampo con coperchio - Size mould with lid: 27,2 x 36,4 x H 7,8 cm

Confezione: etichetta adesiva / Packaging: sticker



230°C
MAX

Temperatura
Temperature
Température



Antiaderenza
Non-stick
Antiadhérence



2
Strati antiaderente
Non-stick layers
Couches antiadhésives



Resistenza ai graffi
Scratch resistance
Résistance aux rayures



Garanzia
Warranty
Garantie

FACILE DA PULIRE
EASY TO CLEAN
FACILE A NETTOYER

NON-STICK PRO

COTTURA SANA - NO GRASSI
HEALTHY BAKING - NO FATS
CUISINE SAINE
PAS DE GRAISSES

FREE
BPA - PFOA
HEALTHY
COATING

Guardini



pizza & mania



Una gamma specifica per la cottura in forno della pizza, in diversi formati. Linea Pizza&Mania, per sfornare e servire senza difficoltà tutto il gusto della tradizione italiana.

Realizzata in acciaio Hi-Top con rivestimento antiaderente Skandia Xtreme Plus doppio strato, la linea garantisce la cottura perfetta e la facile sfornatura di pizze di tutti i generi.

A special range for cooking pizzas, in different shapes. With Pizza&Mania, all the pleasure and taste of Italian tradition can now be served up directly from the oven.

Made of Hi-Top steel with a Skandia Xtreme Plus double layer coating, this line ensures perfect results and easy food release.



VISTA FRONTE - FRONT VIEW

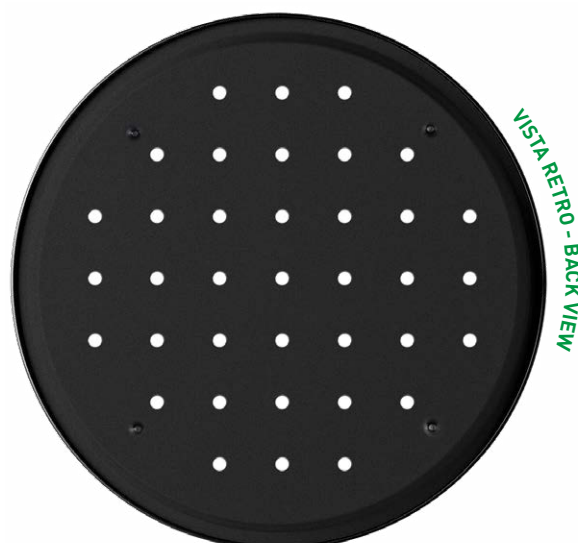

VISTA RETRO - BACK VIEW

MADE in ITALY

Tegame pizza

Pizza tin
Plaque à pizza
Pizzaform
Molde para pizza



CODE	CM	H CM	PACK	EAN
27528	ø 28	1,5	24	8006043 275285
27532	ø 32	1,5	24	8006043 275322

Confezione: etichetta / Packaging: label

Tegame pizza surgelata

Frozen pizza tin
Plaque à pizza surgelée
Pizzaform
Molde para pizza congelada



CODE	CM	H CM	PACK	EAN
27732EX	ø 32	1,5	12	8006043 277326

Confezione: etichetta / Packaging: label

Teglia rettangolare

Baking sheet
Plaque à four rectangulaire
Herbbackblech
Bandeja rectangular



CODE	CM	H CM	PACK	EAN
28526	26 x 37	2,1	24	8006043 285260
28532	32 x 37	2,1	24	8006043 285321

Confezione: etichetta / Packaging: label

ø 32

Set 10 pezzi pizza

Gift box (10 pcs set)
Boîte cadeau (lot de 10 pièces)
Geschenkspaket (10 Stück)
Caja regalo (10 piezas)



CODE	CM	PACK	EAN
27514RK	34 x 34 x 8	4	8006043 275148

Confezione: scatola / Packaging: box
Per maggiori dettagli: vedi pag. 139 / For more details: see page 139



ø 28

I love pizza - 5 pezzi

Set 4 tegami pizza + supporto in acciaio
Set 4 pizza tins with steel grill rack
Lot 4 moules à pizza avec support en acier
4 Pizzaform+pizzabäcker-set
Set 4 bandejas pizza + soporte en acero



CODE	CM	PACK	EAN
27516RK	31 x 31 x 5	4	8006043 013818

Confezione: scatola / Packaging: box
Per maggiori dettagli: vedi pag. 139 / For more details: see page 139

Griglia porta pizze

Steel grill rack for pizza tins
Support en acier pour moules à pizza
Pizzabäcker-set
Soporte porta pizzas

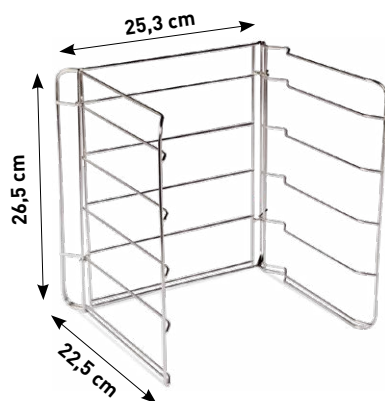

CODE	CM	H CM	PACK	EAN
15608E	25,3 x 22,5	26,5	12	8006043 156089

Adatta per tegami pizza da ø 28 cm e ø 32 cm
Suitable for pizza tin ø 28 cm and ø 32 cm

Confezione: fascia in cartoncino appendibile
Packaging: with hangable carton label



Set 3 tegami pizza + griglia porta pizze

Set 3 pizza tins with steel grill rack
Lot 3 moules à pizza avec support en acier
3 Pizzaform+pizzabäcker-set
Set 3 bandejas pizza + soporte en acero



CODE	CM	H CM	PACK	EAN
27526RK	30 x 30	26,5	6	8006043 014594

Dimensione della griglia con tegami pizza inseriti
Sizes of opened grill rack with pizza tins

Confezione: film + etichetta / Packaging: film + label



Set 4 tegami pizza + griglia porta pizze

Set 4 pizza tins with steel grill rack
Lot 4 moules à pizza avec support en acier
4 Pizzaform+pizzabäcker-set
Set 4 bandejas pizza + soporte en acero



CODE	CM	H CM	PACK	EAN
27535RK	34 x 34	26,5	6	8006043 014600

Dimensione della griglia con tegami pizza inseriti
Sizes of opened grill rack with pizza tins

Confezione: film + etichetta / Packaging: film + label



Mini display Pizza

Cubic mini box
Mini présentoir cubique
Kubisch Mini Box
Mini expositor cubico



CM	H CM
40 x 40	76



Guardini®



RICORRENZE CELEBRATIONS

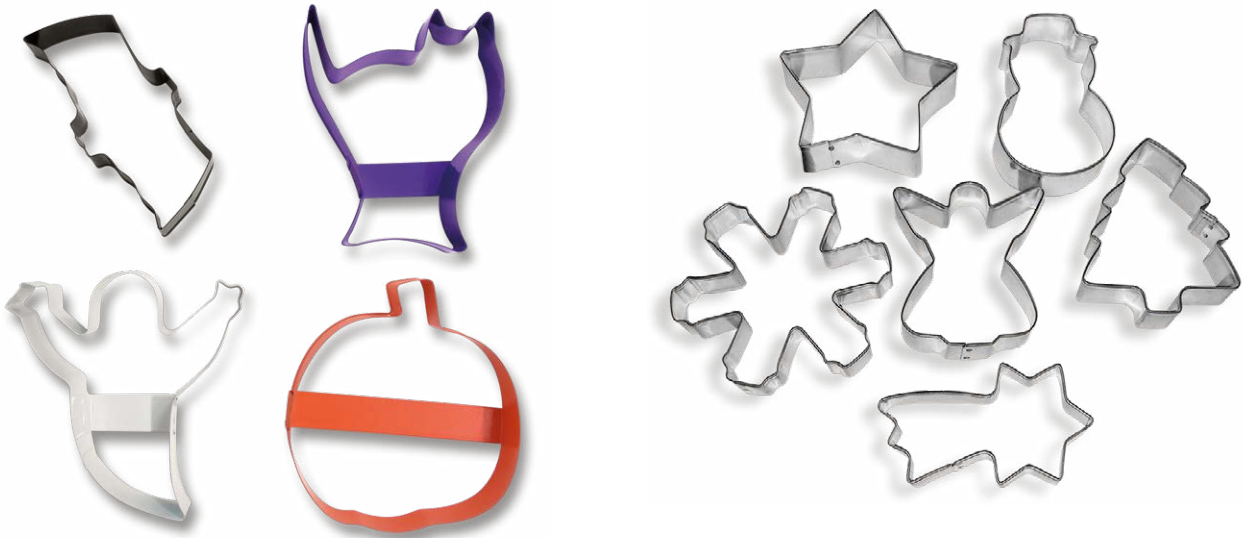

Gli eventi promozionali di Guardini sono sempre dei momenti importanti, ricchi di fantasia, di colore e di convenienza. Per queste occasioni Guardini presenta diversi prodotti per valorizzare l'offerta sul lineare e stimolare il piacere della cucina.

Halloween e Natale sono le ricorrenze raggruppate nell'offerta Guardini. Stampi e tagliabiscotti a tema daranno colore, forma e allegria alle feste più attese.

Guardini promotional events are always important moments, full of fantasy and colours. For these occasions Guardini presents different products that could provide value to the shops and make holiday baking a joy.

With this line Guardini celebrates: Halloween and Christmas. These moulds and cookie cutters will give your holidays the perfect shape, color and happiness.



HALLOWEEN

**Pirottini
da forno**

*Paper cupcakes
Barquettes en papier
Muffin-Papierbackförmchen
Moldes papel*



CODE	CM	H CM	PZ	PACK	EAN
15828	ø 7	2,6	60	12	8006043 019155

Confezione: sacchetto trasparente in PVC / Packaging: PVC transparent bag

**Tagliabiscotti
Halloween**

*Halloween cookie cutters
Découpe-pâtes Halloween
Halloween Ausstechformen
Corta galletas Halloween*



CODE	PACK	EAN
15651	12	8006043 156515

Confezione: blister / Packaging: blister

NATALE - CHRISTMAS

**Stampo per
Pan di Spagna**

**Omino Pan
di Zenzero**

*Mould for sponge cake
Gingerbread Man*
*Moule pour quatre quarts
Bonhomme en pain d'épices*
*Backform für Biskuitkuchen
Lebkuchenmann*
*Molde para bizcocho esponjoso
Hombre de pan de jengibre*



CODE	CM	H CM	PACK	EAN
15799	14,7 x 20	6	6	8006043 015485

Confezione: astuccio / Packaging: box



**Stampo per
Pan di Spagna**

Stella di Natale

*Mould for sponge cake
Christmas Star*
*Moule pour quatre quarts
Etoile de Noël*
*Backform für Biskuitkuchen
Weihnachtsstern*
*Molde para bizcocho esponjoso
Estrella de Navidad*



CODE	CM	H CM	PACK	EAN
15800	20 x 20	6	6	8006043 015492

Confezione: astuccio / Packaging: box

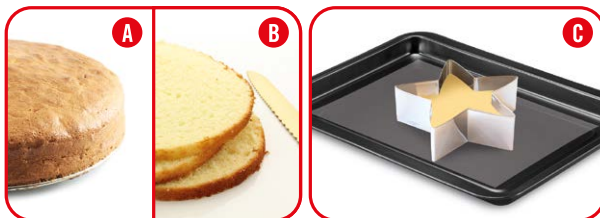

**Stampo per
Pan di Spagna**

Albero di Natale

*Mould for sponge cake
Christmas tree*
*Moule pour quatre quarts
Sapin de Noël*
*Backform für Biskuitkuchen
Weihnachtsbaum*
*Molde para bizcocho esponjoso
Árbol de Navidad*



CODE	CM	H CM	PACK	EAN
15801	13,7 x 20	6	6	8006043 015508

Confezione: astuccio / Packaging: box

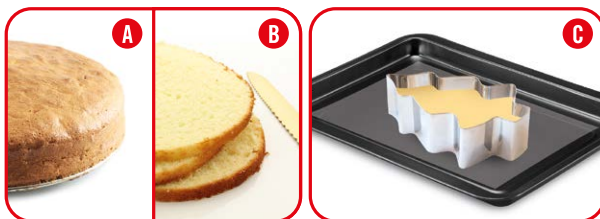

IDEE PER L'UTILIZZO

- A - Incidi direttamente la torta.
- B - Incidi i dischi di pan di spagna e farcisci.
- C - Versa l'impasto direttamente nello stampo.

IDEAS FOR THE USE

- A - Make the cake directly.
- B - Cut the sponge cake discs and stuff.
- C - Pour the mixture directly into the mold.

IDEES D'UTILISATION

- A - Faire le gâteau directement.
- B - Coupez les disques en forme de génoise.
- C - Versez le mélange directement dans le moule.

NATALE - CHRISTMAS

**Tagliabiscotti
Natale**

Christmas cookie cutters
Découpe-pâtes Noël
Weihnachten Ausstechformen
Corta galletas Navidad



CODE	PACK	EAN
15654	12	8006043 156546

Confezione: blister / Packaging: blister

**Tagliabiscotti
Pan di Zenzero**

Gingerbread cookie cutters
Découpe-pâtes "Le bonhomme
pain d'épice"
Lebkuchen Ausstechformen
sortiert
Corta galletas "El hombrecito
de pan de gengibre"



CODE	PACK	EAN
15660	12	8006043 156607

Confezione: blister / Packaging: blister

3D Tagliabiscotti natalizi

3D Christmas cookie cutters
3D Emporte-pièces de Noël
3D Weihnachten Ausstechformen
3D Cortagalletas de Navidad



CODE	PACK	EAN
15802	6	8006043 015515

Confezione: astuccio / Packaging: box

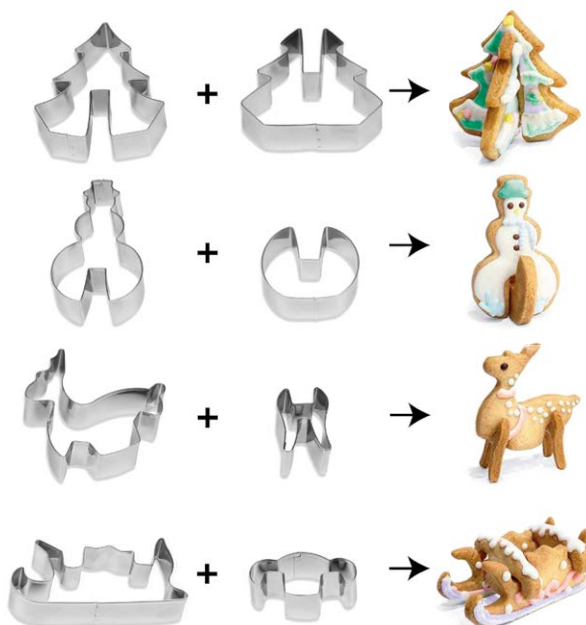

Anello con 8 Tagliabiscotti

Ring with 8 cookie cutters
Anneau avec 8 découpe-pâtes
Ring mit 8 hausstechenformen
Anillo de 8 corta galletas



CODE	PACK	EAN
15632E	24	8006043 008418

Confezione: astuccio / Packaging: box



Display Albero di Natale con 110 anelli da 8 tagliabiscotti

Christmas tree with 110 rings
of 8 cookie cutters
Sapin de Noël avec 110 anneaux
de 8 découpe-pâtes
Tannenbaum-standdisplay mit 110 ringe
von 8 hausstechenformen
Arbol de Navidad con 110 anillos
de 8 corta galletas

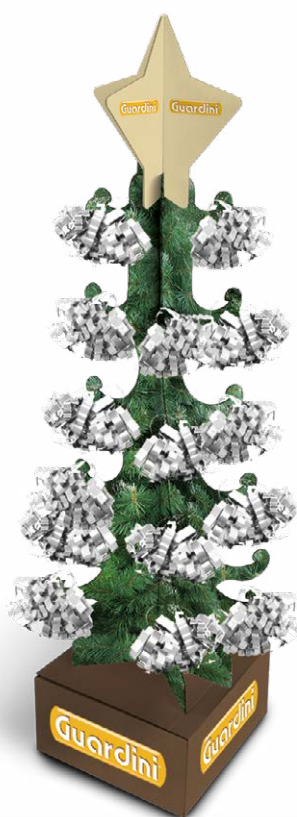

CODE	CM	H CM	PACK	EAN
15785A	40 x 40	160	1	8006043 010848



Crostata di pere e crema alle mandorle

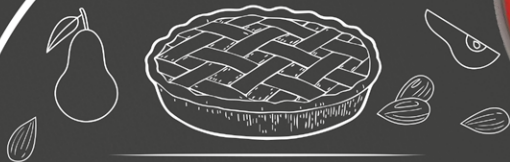

INGREDIENTI PER 10 PERSONE

1 rotolo di pasta frolla già pronta, 100 g di burro, 100 g di zucchero, 100 g di farina di mandorle, 2 uova, 400 g di pere sciroppate, lamelle di mandorle.

PROCEDIMENTO

Posizionare la pasta frolla nello stampo crostata. Poi con una forchettina bucherellare la base. Lavorare il burro ammorbidito in precedenza con lo zucchero. Poi aggiungere le uova e mescolare per bene. Infine incorporare la farina di mandorle e mescolare nuovamente. Versare nello stampo la crema di mandorle ottenuta e livellarla con una spatola. Tagliare a fettine sottili le pere nel senso della larghezza cercando di mantenere integra la forma del frutto.

Poi adagiarle sulla crema di mandorle. Spolverare la superficie con le lamelle di mandorle. Informare per 30 minuti a 180°C. La golosa crostata è pronta!

WE WISH YOU A
Merry
CHRISTMAS
AND HAPPY
NEW YEAR!



Guardini

TAMPOGRAFIA - PAD PRINTING

ALCUNE DELLE NOSTRE PRODUZIONI - SOME OF OUR PRODUCTIONS

You Tube



ESEMPIO TAMPOGRAFIA INTERNA
EXAMPLE INTERNAL PAD PRINTING

Una tecnologia di stampa che dà la possibilità di stampare in **alta qualità** elementi grafici sugli stampi da forno. Questa tecnologia permette di stampare **fino a 6 colori** (quadricromia + 2 colori pantone) resistenti alle alte temperature e al lavaggio.

Nuove e infinite possibilità di espressione grafica sono ora realizzabili, ideali per attività di **licensing** e **progetti personalizzati** per specifiche esigenze. La stampa tampografica è **realizzata e gestita internamente**, garantendo così flessibilità e una risposta rapida a tutte le specifiche richieste.

È anche possibile realizzare la tampografia all'interno dello stampo, utilizzando esclusivamente **inchiostri alimentari** testati per un utilizzo in forno fino a 230°C (tampografia interna realizzabile a 1 colore, bianco).

A technology which permits to print **HD quality** photos and graphics on our bakeware moulds. Thanks to this technology it is possible to print with **4 colour process + 2 pantone colours** decorations resistant to oven temperature and washing.

It is then a **new promotional possibility**, particularly suitable for licensing and customized project. The decoration process is **entirely arranged in our factory**, granting flexibility and fast response to customers' needs.

It is also possible to carry out the pad printing **inside the mould**, using exclusively **food inks** tested for use in the oven up to 230°C (internal pad printing available in 1 colour, white).



ESEMPIO TAMPOGRAFIA ESTERNA
EXAMPLE EXTERNAL PAD PRINTING



MADE in ITALY



Guardini®

STAMPI IN ALLUMINIO PRESSOFUSO
CAST ALUMINIUM MOULDS



Testati e consigliati dai Pastry Chefs della I.F.S.E., la più innovativa scuola di Alta Cucina e Pasticceria d'Italia.

Tested and recommended by the I.F.S.E. Pastry Chefs, the most innovative Italian school of haute cuisine and pastry.

Testés et recommandés par les Pâtisseries de I.F.S.E., la plus innovante école italienne de haute cuisine et de pâtisserie.



USO PROFESSIONALE E CASALINGO
PROFESSIONAL USE AND HOME BAKING
USAGE PROFESSIONNEL ET MAISON

- 96 Sweet Magic
- 98 Lily Flower
- 98 Classic
- 99 Marquise
- 99 Cascade
- 100 Belle
- 100 Marissa
- 101 Espositore - Display



230°C MAX
 Temperatura
 Temperature
 Température

TOP 
 Antiaderenza
 Non-stick
 Antiadhérence

2 
 Strati antiaderente
 Non-stick layers
 Couches antiadhésives

TOP 
 Resistenza ai graffi
 Scratch resistance
 Résistance aux rayures

5 ANNI • YEARS
 Garanzia
 Warranty
 Garantie

**FACILE UTILIZZO
 OTTIMI RISULTATI**
**EASY TO USE
 EXCELLENT RESULTS**
**FACILE A UTILISER
 EXCELLENTS RESULTATS**

Guardini®



Sweet Magic



La gamma **Sweet Magic** è una linea di stampi da forno realizzata in **alluminio pressofuso**, per la realizzazione di torte creative. Le forme eleganti permettono di realizzare in modo **casalingo** o **professionale** torte creative, dal **risultato assicurato**. Tale eleganza è combinata con prestazioni antiaderenti di **alta qualità e resistenza ai graffi e all'usura**, grazie ai **2 strati di antiaderente**. La gamma si presenta con un **pack elegante**, descrittivo, completo di tutte le informazioni per una vendita di successo.

The **Sweet Magic** range is composed by oven moulds made of **cast aluminum**, for the realization of creative cakes. The elegant shapes allow you to make **homemade** or **professional** cakes, with **guaranteed results**. This elegance is combined with a **high-quality non-stick performance** and a resistance to scratches and use, thanks to the **2 layers of non-stick coating**. The range has an elegant, descriptive **pack**, complete with all the information for a successful sale.



Stampi da forno per torte creative

Baking moulds for creative cakes - Moules pour gâteaux créatifs - Backformen für kreative Kuchen - Moldes para pasteles creativos



CODE	CM	H CM	PACK	EAN
LV-104	ø 23,5	10	4	8006043 014969

Confezione: scatola / Packaging: box



★ Lily Flower ★



CODE	CM	H CM	PACK	EAN
LV-105	ø 23,5	10	4	8006043 014976

Confezione: scatola / Packaging: box



★ Classic ★



Stampi da forno per torte creative

Baking moulds for creative cakes - Moules pour gâteaux créatifs - Backformen für kreative Kuchen - Moldes para pasteles creativos



CODE	CM	H CM	PACK	EAN
LV-111	ø 24,5	10	4	8006043 014983

Confezione: scatola / Packaging: box



★ **Marquise** ★



CODE	CM	H CM	PACK	EAN
LV-115	ø 24	11	4	8006043 014990

Confezione: scatola / Packaging: box



★ **Cascade** ★



Stampi da forno per torte creative

Baking moulds for creative cakes - Moules pour gâteaux créatifs - Backformen für kreative Kuchen - Moldes para pasteles creativos



CODE	CM	H CM	PACK	EAN
LV-126	ø 24,5	9,5	4	8006043 015003

Confezione: scatola / Packaging: box



★ Belle ★



CODE	CM	H CM	PACK	EAN
LV-186	ø 24	9	4	8006043 015010

Confezione: scatola / Packaging: box



★ Marissa ★



Espositore

Display
Présentoir
Display
Expositor

CODE	PACK
90134	1



*L'espositore da banco è adatto a tutte le forme della linea Sweet Magic.
The counter display is suitable for all moulds of the Sweet Magic line.*



ADATTO A DIVERSE TIPOLOGIE DI IMPASTO

- Impasto montato al burro;
- impasto liquido;
- impasto lievitato;
- impasto morbido.

SUITABLE FOR DIFFERENT TYPES OF DOUGH

- Dough mounted with butter;
- liquid mixture;
- leavened mixture;
- soft dough.

APPROPRIÉ À DIFFÉRENTS TYPES DE PÂTE

- Pâte montée au beurre ;
- mélange liquide ;
- pâte levée ;
- pâte molle.



OTTIMA ANTIADERENZA

Antiaderente eccellente che garantisce ottimi risultati con il minimo sforzo. Ungere sempre l'interno dello stampo con un velo uniforme di olio, burro o margarina in modo che le insenature risultino perfette.

EXCELLENT NON-STICK

Excellent non-stick that guarantees excellent results with minimum effort. Always grease the inside of the mould with a uniform veil of oil, butter or margarine so that the inlets will be perfect.

EXCELLENT ANTIADHÉSIF

Excellent antiadhésif qui garantit d'excellents résultats avec un minimum d'effort. Toujours graisser l'intérieur du moule avec un voile uniforme d'huile, de beurre ou de margarine afin que les profondeurs soient parfaites.



TIPOLOGIA DI COTTURA

- Adatto al forno statico;
- adatto al forno ventilato;
- adatto al forno a gas.

BAKING TYPE

- Suitable for static oven;
- suitable for ventilated oven;
- suitable for the gas oven.

TYPE DE CUISSON

- Approprié pour four statique ;
- approprié pour four ventilé ;
- approprié pour le four à gaz.



OTTIMA SFORMABILITÀ

L'ottima antiaderenza garantisce una sformabilità eccellente per presentazioni ad effetto.

EXCELLENT DEMOULDING

The excellent non-stick guarantees excellent demoulding for effective presentations.

EXCELLENT DEMOULAGE

L'excellent antiadhésif garantit un excellent démoulage pour des présentations efficaces.



Guardini

**COLLEZIONE CARTA & PLASTICA
PAPER & PLASTIC COLLECTION**



Stampi cottura tondi e rettangolari
Round and rectangular baking moulds



Pizzi e porta torte
Lace doilies and cake carry box



Pirottini e muffins
Paper cupcakes and muffins



Ricorrenze
Celebrations



Vassoi in cartoncino
Paper trays



Vassoi in plastica
Plastic trays



Guardini®



EASY Bake



Easy Bake è una collezione che si compone di stampi in carta e plastica per la cottura in forno di preparazioni dolci e salate, di vassoi per la presentazione di dolcetti e salatini, di pirottini per la preparazione di muffin e cupcake, di pizzi e portatorte per il trasporto fuori casa. Pratici e convenienti, i prodotti della linea Easy Bake sono realizzati utilizzando differenti materiali, tutti adatti al contatto alimentare, nel rispetto dell'ambiente e delle normative vigenti. I prodotti della collezione Easy Bake sono rigorosamente **MADE IN ITALY**.

Easy Bake is a collection composed by paper and plastic moulds and serving trays for sweets and savouries, paper cupcakes ideal for baking muffins and cupcakes, doilies and cake boxes. Practical and affordable, Easy Bake products are made using different materials, all suitable for food contact, respecting the environment and regulations. Easy Bake is an entirely **MADE IN ITALY** collection.



MADE in ITALY



Stampi cottura tondi e rettangolari Round and rectangular baking moulds

Stampo crostatina

Pie baking mould
Tartelette en papier
Tortelett in Papier
Molde tartaleta



CODE	CM	H CM	PZ	PACK	EAN
15754I6	ø 10	3	6	12	8006043 008630

Confezione: sacchetto trasparente in PVC / Packaging: PVC transparent bag

Stampo crostatina

Pie baking mould
Tartelette en papier
Tortelett in Papier
Molde tartaleta



CODE	CM	H CM	PZ	PACK	EAN
15755I6	ø 9	2,3	6	12	8006043 008647

Confezione: sacchetto trasparente in PVC / Packaging: PVC transparent bag

Stampo brownies

Brownies baking mould
Moule à brownies
Brownies backform
Molde brownies



CODE	CM	H CM	PZ	PACK	EAN
15756I6	16 x 16	2,5	3	12	8006043 008654

Confezione: sacchetto trasparente in PVC / Packaging: PVC transparent bag

Stampo mini-plumcake

Mini-loaf pan
Mini cake
Mini Kuchen
Mini bizcocho



CODE	CM	H CM	PZ	PACK	EAN
15757I4	8 x 4	4	6	12	8006043 008661

Confezione: sacchetto trasparente in PVC / Packaging: PVC transparent bag

Stampo plumcake

Loaf pan
Moule à cake
Königskuchenform
Molde bizcocho



CODE	CM	H CM	PZ	PACK	EAN
15758I4	16 x 5,5	5,7	3	12	8006043 008678

Confezione: sacchetto trasparente in PVC / Packaging: PVC transparent bag

Stampo plumcake

Loaf pan
Moule à cake
Königskuchenform
Molde bizcocho



CODE	CM	H CM	PZ	PACK	EAN
15759I4	23 x 7	7	3	12	8006043 008685

Confezione: sacchetto trasparente in PVC / Packaging: PVC transparent bag

Stampo torta

Round baking mould
Moule à clafoutis
Kuchenform
Molde alto



CODE	CM	H CM	PZ	PACK	EAN
15760I4	ø 21	3	3	12	8006043 008692

Confezione: sacchetto trasparente in PVC / Packaging: PVC transparent bag

Stampo ciambella

Savarin paper mould
Moule à savarin
Kranzform
Molde savarin



CODE	CM	H CM	PZ	PACK	EAN
15762I4	ø 20	7	3	12	8006043 008715

Confezione: sacchetto trasparente in PVC / Packaging: PVC transparent bag

Stampo crostata

Flan tin
Moule à tarte
Obsttortenboden
Molde rizado



CODE	CM	H CM	PZ	PACK	EAN
15763I4	ø 25	3	2	12	8006043 008722

Confezione: sacchetto trasparente in PVC / Packaging: PVC transparent bag



Pirottini e muffins Paper cupcakes and muffins

Pirottini carta da forno

Paper cupcakes
Barquettes en papier
Papier-backförmchen
Moldes papel



CODE	CM	H CM	PZ	PACK	EAN
15749	ø 7	3	100	12	8006043 008586

Confezione: sacchetto trasparente in PVC / Packaging: PVC transparent bag

Pirottini carta da forno

Paper cupcakes
Barquettes en papier
Papier-backförmchen
Moldes papel



CODE	CM	H CM	PZ	PACK	EAN
15751	ø 4,3	2,3	100	12	8006043 008609
15750	ø 7	3	100	12	8006043 008593

Confezione: sacchetto trasparente in PVC / Packaging: PVC transparent bag

Pirottini tulipano carta da forno

Tulip paper cupcakes
Cupcakes tulip en papier
Papier-backförmchen tulip
Moldes papel tulip



CODE	CM	H CM	PZ	PACK	EAN
15752I6	ø 7,5	8	12	12	8006043 008616

Confezione: sacchetto trasparente in PVC / Packaging: PVC transparent bag

Muffins carta da forno

Paper muffins
Barquettes en papier
Papier-backförmchen
Moldes papel



CODE	CM	H CM	PZ	PACK	EAN
15753	ø 5	4	6	12	8006043 008623

Confezione: sacchetto trasparente in PVC / Packaging: PVC transparent bag



Vassoi in cartoncino
Paper trays

Vassoio bianco cartoncino

White paper tray
Plateau carton couleur blanc
Weissenen Papierfach
Bandeja de papel blanco



CODE	CM	PZ	PACK	EAN
15745BI6	23 x 31	3	12	8006043 010237
15793I6	28 x 42	2	12	8006043 013436
15742I6	33 x 43	2	12	8006043 008517

Confezione: sacchetto trasparente in PVC / Packaging: PVC transparent bag

Vassoio oro cartoncino

Golden paper tray
Plateau carton couleur or
Goldenen Papierfach
Bandeja de papel dorado



CODE	CM	PZ	PACK	EAN
15794	ø 24	3	12	8006043 013450
15743I6	ø 31	3	12	8006043 008524
15744I6	ø 34	2	12	8006043 008531

Confezione: sacchetto trasparente in PVC / Packaging: PVC transparent bag

Vassoio oro cartoncino

Golden paper tray
Plateau carton couleur or
Goldenen Papierfach
Bandeja de papel dorado



CODE	CM	PZ	PACK	EAN
15792C	19 x 28	3	12	8006043 013429
15745I6	23 x 31	3	12	8006043 008548
15793C	28 x 42	2	12	8006043 013443
15742C	33 x 43	2	12	8006043 010220

Confezione: sacchetto trasparente in PVC / Packaging: PVC transparent bag



Pizzi e porta torte Lace doilies and cake carry box

Pizzi sotto torta polistirene

Plastic lace doilies
Napperons plastique
Plastic-tortenspitzen
Encaje bajo-cake en plàstico



CODE	CM	PZ	PACK	EAN
15740	ø 32	2	12	8006043 008494

Confezione: sacchetto trasparente in PVC / Packaging: PVC transparent bag

Pizzi sotto torta carta

Lace doilies
Napperons papier
Papier-tortenspitzen
Encaje bajo-cake

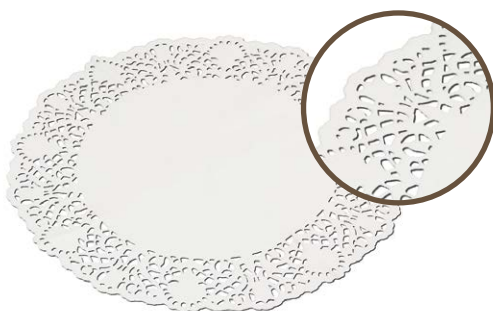

CODE	CM	PZ	PACK	EAN
15746	ø 28	5	12	8006043 008555

Confezione: sacchetto trasparente in PVC / Packaging: PVC transparent bag

Pizzi sotto torta carta

Lace doilies
Napperons papier
Papier-tortenspitzen
Encaje bajo-cake



CODE	CM	PZ	PACK	EAN
15747	ø 36	5	12	8006043 008562

Confezione: sacchetto trasparente in PVC / Packaging: PVC transparent bag

Pizzi sotto torta carta

Lace doilies
Napperons papier
Papier-tortenspitzen
Encaje bajo-cake

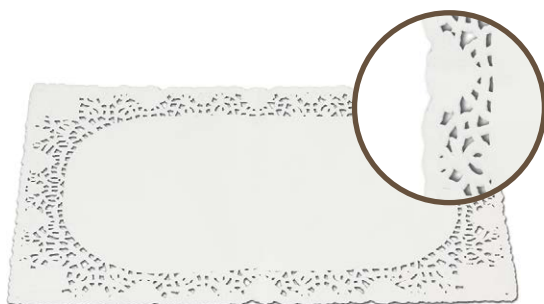

CODE	CM	PZ	PACK	EAN
15748	20 x 30	5	12	8006043 008579
15780	30 x 40	5	12	8006043 010183

Confezione: sacchetto trasparente in PVC / Packaging: PVC transparent bag

Scatola porta torte

Cake carry box
Boîte emporte-gâteaux
Tortenschachtel
Cajas para tartas



CODE	CM	H CM	PZ	PACK	EAN
15761	29 x 29	9	1	12	8006043 008708
15767	33 x 33	11,5	1	12	8006043 010169

Confezione: sacchetto trasparente in PVC / Packaging: PVC transparent bag

Sotto torta oro cartoncino

Golden cake board
Sous-gâteau couleur or
Gold tortenuntersätze
Subpastel oro



CODE	CM	PZ	PACK	EAN
1576516	ø 32	2	12	8006043 008746

Confezione: sacchetto trasparente in PVC / Packaging: PVC transparent bag



**Ricorrenze
Celebrations**

Stampo colomba carta da forno

"Colomba" shaped paper mould
Forme "Colomba" en papier
"Colomba" form in Backpapier
Forma "Colomba" en papel



CODE	CM	H CM	PZ	PACK	EAN
15781	19,6 x 27,5 (500 g)	5	3	12	8006043 010190
15782	23,5 x 33 (1000 g)	6,5	2	12	8006043 010206

Confezione: sacchetto trasparente in PVC / Packaging: PVC transparent bag

Stampo albero carta da forno

Xmas tree paper baking mould
Forme sapin de Noël en papier
Baumform in Backpapier
Forma arbol de Navidad en papel



CODE	CM	H CM	PZ	PACK	EAN
15766I	25 x 32 (900 g)	6	2	12	8006043 008753

Confezione: sacchetto trasparente in PVC / Packaging: PVC transparent bag

Stampo stella carta da forno

Star shaped paper mould
Forme étoile en papier
Sternform in Backpapier
Forma estrella en papel



CODE	CM	H CM	PZ	PACK	EAN
15768I	25 x 21 (500 g)	6	3	12	8006043 008777

Confezione: sacchetto trasparente in PVC / Packaging: PVC transparent bag

Panettone alto carta da forno

Panettone baking mould
Moule à panettone
Panettone backform
Molde panettone



CODE	CM	H CM	PZ	PACK	EAN
15769	ø 15,5 (750 g)	11,5	2	12	8006043 008784

Confezione: sacchetto trasparente in PVC / Packaging: PVC transparent bag

Panettone basso carta da forno

Panettone baking mould
Moule à panettone
Panettone backform
Molde panettone



CODE	CM	H CM	PZ	PACK	EAN
15770	ø 19 (750 g)	6	3	12	8006043 008791

Confezione: sacchetto trasparente in PVC / Packaging: PVC transparent bag



Vassoi in plastica
Plastic trays

Vassoio crystal polistirene

Plastic tray
Plateau en plastique
Tablett in Plastik
Bandejas de plástico



CODE	CM	PZ	PACK	EAN
15777	ø 27	3	12	8006043 010176
15741	ø 33	2	12	8006043 008760

Confezione: sacchetto trasparente in PVC / Packaging: PVC transparent bag

Vassoio oro PET-PET

Plastic golden tray
Plateau en plastique couleur or
Goldenen Tablett in Plastik
Bandeja de plástico dorado



CODE	CM	PZ	PACK	EAN
15764	ø 28	2	12	8006043 008739

Confezione: sacchetto trasparente in PVC / Packaging: PVC transparent bag

Vassoio ovale polistirene

Plastic tray
Plateau en plastique
Tablett in Plastik
Bandeja de plástico



CODE	CM	PZ	PACK	EAN
15778	46 x 23	2	12	8006043 008890

Confezione: sacchetto trasparente in PVC / Packaging: PVC transparent bag

Mini display

*Cubic mini box
Mini présentoir cubique
Kubisch Mini Box
Mini expositor cubico*



CM	H CM
60 x 40	100

Espositore Easy Bake

*Display
Présentoir
Display
Expositor*



CM	H CM
57,5 x 38	112

La linea Easy Bake è disponibile in un pratico espositore, che permette di allestire il punto vendita e presentare la linea in modo ordinato e attraente.

The Easy Bake range dedicated display is the ideal solution to lay out the products in the store.



Guardini®

STAMPI IN SILICONE
SILICONE MOULDS



118 Juliette



- Più pratici in cucina
- Flessibili ed antiaderenti
- Sformabilità facile e perfetta
- Semplici da pulire
- Handy and practical for your baking
- Easy storage
- Easy food release
- Easy cleaning after use

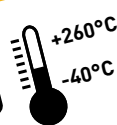



Guardini®



Juliette



Juliette è una linea completa di stampi in silicone per cottura e surgelazione, flessibili ed antiaderenti. Gli stampi in silicone consentono una sfornabilità facile e perfetta, inoltre possono essere riposti con facilità ovunque, sono semplici da pulire, sia a mano che in lavastoviglie.

Gli stampi Juliette sono interamente realizzati in puro silicone alimentare, un materiale conforme alle più severe norme internazionali che regolano l'utilizzo di materiali destinati al contatto con gli alimenti. Ideali per la cottura e la surgelazione, gli stampi in silicone possono essere utilizzati nel forno tradizionale, nel microonde, in frigorifero e nel freezer, perché il silicone alimentare può resistere a temperature da -40°C a 260°C.

Juliette is a complete range of flexible and non-stick silicone pans. Thanks to the material characteristics, they could be stored anywhere, they are easy to clean and suitable to use in oven, microwave, freezer and dishwasher.

Juliette pans are entirely made of platinum silicone in compliance with stringent international standards for food-safe materials. Suitable for cooking and freezing, silicone pans can be used in traditional ovens, microwaves, refrigerator, and even in the freezer because they resist temperatures from -40°C to 260° C.

VISTA FRONTE - FRONT VIEW



VISTA RETRO - BACK VIEW

MADE in ITALY

Tortiera liscia

Round cake tin
Moule à clafoutis
Kuchenform
Molde tarta lisa



CODE	CM	H CM	PACK	EAN
69124EE	ø 24	4,5	6	8006043 691245

Confezione: fascia in cartoncino appendibile / Packaging: with hangable carton label

Gugelhupf

Bundtform
Kugelhupf
Gugelhupf
Flanera con cono



CODE	CM	H CM	PACK	EAN
69250EE	ø 22	10,7	6	8006043 692501

Confezione: fascia in cartoncino appendibile / Packaging: with hangable carton label

Stampo corolla

Flower cake pan
Moule à fleur
Backform corolla
Molde flor



CODE	CM	H CM	PACK	EAN
69220EE	ø 22	5	6	8006043 692204

Confezione: fascia in cartoncino appendibile / Packaging: with hangable carton label

Stampo ciambella

Savarin cake pan
Moule à savarin
Kranzform
Molde savarin



CODE	CM	H CM	PACK	EAN
69224EE	ø 24	5,5	6	8006043 692242

Confezione: fascia in cartoncino appendibile / Packaging: with hangable carton label

Stampo plumcake

Loaf tin
Moule à cake
Königskuchenform
Molde plumcake



CODE	CM	H CM	PACK	EAN
69326EE	24 x 13	6,5	6	8006043 693263

Confezione: fascia in cartoncino appendibile / Packaging: with hangable carton label

Stampo 6 muffins

6 Muffins pan
Plaque à 6 muffins
6 Muffinform
Molde 6 muffins



CODE	CM	H CM	PACK	EAN
69023EE	16,5 x 25	3,5	6	8006043 690231

Confezione: fascia in cartoncino appendibile / Packaging: with hangable carton label

Stampo 6 briochettes

6 briochettes baking pan
Plaque à 6 briochettes
6 briochettes backenform
Molde 6 briochettes



CODE	CM	H CM	PACK	EAN
69034EE	17 x 29	3,8	6	8006043 690347

Confezione: fascia in cartoncino appendibile / Packaging: with hangable carton label

Stampo 6 cuori

6 hearts baking pan
Plaque à 6 coeurs
6 harten backenform
Molde 6 corazones



CODE	CM	H CM	PACK	EAN
69040EE	17 x 22,5	3,8	6	8006043 690408

Confezione: fascia in cartoncino appendibile / Packaging: with hangable carton label

9 Mini plumcake

9 Mini cakes
9 Mini cakes
9 Mini Kuchen
9 Mini bizcochos



CODE	CM	H CM	PACK	EAN
69327EE	17 x 29,5	3	6	8006043 693270

Confezione: fascia in cartoncino appendibile / Packaging: with hangable carton label

24 Mini bordelais

24 mini bordelais baking pan
Plaque 24 mini bordelais
Backform für 24 mini bordelais
Molde para 24 mini bordelais



CODE	CM	H CM	PACK	EAN
69052EE	17 x 28,5	3,5	6	8006043 690521

Confezione: fascia in cartoncino appendibile / Packaging: with hangable carton label

Tappetino da forno multiuso

Baking mat
Feuille à pâtisserie multi-usages
Backmatte
Salva bandejas



CODE	CM	H CM	PACK	EAN
69429EE	29 x 39	0,2	6	8006043 694291

Confezione: fascia in cartoncino appendibile / Packaging: with hangable carton label

6 Pirottini

6 Cupcakes
6 Caissettes
6 Muffinform
6 Moldes para horno



CODE	CM	H CM	PACK	EAN
69107EE	ø 6,5	3	6	8006043 691078

Confezione: fascia in cartoncino appendibile / Packaging: with hangable carton label





Guardini®

**PIROFILE IN CERAMICA
CERAMIC BAKEWARE**



Versatile
Ideale per il forno a microonde
Dal frigo al forno
Da -18°C a + 250°C

Versatile
Ideal for the microwave
From the freezer to the oven
From -18°C to + 250°C

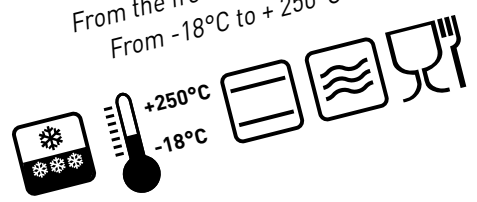



Guardini®



CERAMICA



Una linea completa di stampi da forno in ceramica bianca, che ripropone in modo attuale i metodi e i materiali della cottura tradizionale. Adatti per il forno tradizionale, quello a microonde e perfetti anche come piatti da portata.

Gli stampi da forno in ceramica bianca sono realizzati con un materiale idoneo a garantire la resistenza alle alte temperature e agli shock termici. Estremamente resistenti agli urti, questi strumenti di cottura costituiscono la risposta avanzata per un uso ultra intensivo e per una lunga durata.

A complete range of white ceramic oven dishes, that recreates the traditional baking methods with the most modern materials.

For your convenience, all our ceramic moulds are both microwave and oven-safe and they can go directly from freezer to oven, since they resist to thermal shocks. Their simple white design is perfect for any kitchen and tabletop décor.

The white ceramic is made of a material suitable for high temperatures and it is the forefront for heavy duty use and durability.



Ovale grande

Oval dish
Ovale
Ovales backblech
Molde oval



CODE	CM	H CM	PACK	EAN
C00TC1	36 x 24	6,8	6	8006043 900361

Confezione: etichetta adesiva / Packaging: sticker

Ovale medio

Oval dish
Ovale
Ovales backblech
Molde oval



CODE	CM	H CM	PACK	EAN
C00TC3	30 x 18	6	6	8006043 900323

Confezione: etichetta adesiva / Packaging: sticker

Ovale piccolo

Oval dish
Ovale
Ovales backblech
Molde oval



CODE	CM	H CM	PACK	EAN
C00TC4	22 x 14	5	12	8006043 930221

Confezione: etichetta adesiva / Packaging: sticker

Rettangolare grande

Rectangular dish
Rectangulaire
Rechteckiges Backblech
Molde rectangular



CODE	CM	H CM	PACK	EAN
C00TC7	36 x 24	6	6	8006043 905366

Confezione: etichetta adesiva / Packaging: sticker

Rettangolare medio

Rectangular dish
Rectangulaire
Rechteckiges Backblech
Molde rectangular



CODE	CM	H CM	PACK	EAN
C0TC7A	30 x 18	6,5	6	8006043 905304

Confezione: etichetta adesiva / Packaging: sticker

Rettangolare piccolo

Rectangular dish
Rectangulaire
Rechteckiges Backblech
Molde rectangular



CODE	CM	H CM	PACK	EAN
C0TC7C	22 x 14	5,5	12	8006043 935226

Confezione: etichetta adesiva / Packaging: sticker

Quadro medio

Square dish
Carré
Quadratisches Minibackblech
Molde cuadrado



CODE	CM	H CM	PACK	EAN
C0TC22	25 x 22	5,5	6	8006043 910254

Confezione: etichetta adesiva / Packaging: sticker

Quadro piccolo

Square dish
Carré
Quadratisches Minibackblech
Molde cuadrado



CODE	CM	H CM	PACK	EAN
CTC22C	18 x 16	4,5	12	8006043 940183

Confezione: etichetta adesiva / Packaging: sticker

Tortiera

Flan dish
Moule à tarte
Tortenform
Molde tarta



CODE	CM	H CM	PACK	EAN
C00L12	ø 29	4,5	6	8006043 925296

Confezione: etichetta adesiva / Packaging: sticker

Crème-caramel

Ramekin
Crème-caramel
Crème-caramel
Flanera individual



CODE	CM	H CM	PACK	EAN
C00TC9	ø 9	5,2	12	8006043 015201

Confezione: etichetta adesiva / Packaging: sticker



Guardini®

**ACCESSORI
GADGETS**



132 Coppapasta



- Versatili
- Funzionali
- Molteplici utilizzi

- Versatile
- Functional
- Multiple uses



Guardini®



COPPAPASTA



You Tube 



I coppapasta Guardini sono ideali per tagliare la pasta, per creare dolci o per impiattare a piacimento riso, sformati di verdure, tartare, cucinati in modo originale, elegante e raffinato.

I coppapasta Guardini sono realizzati in acciaio inox e sono disponibili in varie forme e dimensioni. Questi permetteranno anche ai cuochi più esigenti di sbizzarrirsi in cucina e creare piatti originali e sfiziosi.

The Guardini food rings are ideals for cutting the dough in several shapes, create desserts or to serve rice, vegetable pies, tartar in an original, elegant and refined way.

The Guardini food rings are made of stainless steel and come in various shapes and sizes. They will enable even the most demanding chefs to indulge in the kitchen and create original and delicious dishes.



Coppapasta tondo con stantuffo

Round food ring with pusher
 Cercle à pâtisserie rond avec poussoir
 Food-Ring (Rund)
 Aro redondo con pisador



CODE	CM	H CM	PACK	EAN
15663	ø 7	6	12	8006043 156638

Confezione: astuccio trasparente / Packaging: transparent box

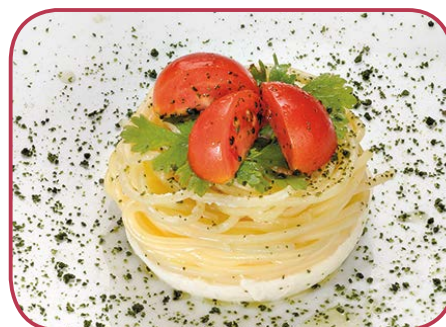

Coppapasta rettangolare con stantuffo

Rectangular food ring with pusher
 Cercle à pâtisserie rectangulaire avec poussoir
 Food-Ring (Rechteckig)
 Aro rectangular con pisador



CODE	CM	H CM	PACK	EAN
15665	9 x 5	6	12	8006043 156652

Confezione: astuccio trasparente / Packaging: transparent box



Coppapasta quadrato con stantuffo

Square food ring with pusher
 Cercle à pâtisserie carré avec poussoir
 Food-Ring (Viereckig)
 Aro cuadrado con pisador



CODE	CM	H CM	PACK	EAN
15666	6 x 6	6	12	8006043 156669

Confezione: astuccio trasparente / Packaging: transparent box



Coppapasta cuore con stantuffo

Heart food ring with pusher
Cercle à pâtisserie coeur avec poussoir
Food-Ring (Herzform)
Aro corazon con pisador



CODE	CM	H CM	PACK	EAN
15667	6 x 6	6	12	8006043 156676

Confezione: astuccio trasparente / Packaging: transparent box



Coppapasta ovale con stantuffo

Oval food ring with pusher
Cercle à pâtisserie oval avec poussoir
Food-Ring (Oval)
Aro oval con pisador



CODE	CM	H CM	PACK	EAN
15668	9 x 5	6	12	8006043 156683

Confezione: astuccio trasparente / Packaging: transparent box





Guardini®



IDEE REGALO GIFT IDEAS



Guardini riunisce in questa sezione le **Scatole Regalo**. Queste confezioni soddisfano tutte le esigenze e le necessità di chi vuole fare o farsi un regalo originale, divertente e completo, con tutta la qualità che da sempre contraddistingue i prodotti Guardini.

In this section, Guardini gathers together all the **Gift Boxes**. These gift boxes meet all the needs of those who want to treat themselves or buy someone else a funny, complete and original gift, with the quality guarantee that distinguishes the Guardini products.

Starting Set

Set 4 stampi da forno

Set of 4 non-stick coating moulds

Lot de 4 moules à gâteaux anti-adhérents

Backformen-set (4 tlg)

Set 4 moldes en acero antiadherente



CODE	CM	PACK	EAN
89992	30 x 35 x 15	4	8006043 013658

Confezione: scatola / Packaging: box

La scatola **Starting set** contiene un set di 4 stampi:

- 1 tortiera apribile 1 fondo con salvagocia (ø 24 cm)
- 1 stampo crostata (ø 28 cm)
- 1 stampo plumcake (30 cm)
- 1 stampo budino con cono (ø 23 cm)

Tutti gli stampi sono realizzati in acciaio Hi-Top con rivestimento antiaderente Skandia Xtreme Plus doppio strato.

The **Starting set** gift box contains:

- 1 springform 1 base with leakproof base (ø 24 cm)
- 1 flan tin (ø 28 cm)
- 1 loaf tin (30 cm)
- 1 bundtform (ø 23 cm)

All these moulds are made of Hi-Top steel with Skandia Xtreme Plus double layer non-stick coating.

Chocoforme

Set 3 stampi da forno

Set of 3 non-stick coating moulds

Lot de 3 moules à gâteaux anti-adhérents

Backformen-set (3 tlg)

Set 3 moldes en acero antiadherente



CODE	CM	PACK	EAN
00737H	30 x 30 x 13,5	4	8006043 000573

Confezione: scatola / Packaging: box

La scatola regalo della linea **Chocoforme** contiene un set di 3 stampi:

- 1 tortiera apribile 1 fondo con salvagocia (ø 26 cm)
- 1 stampo crostata (ø 28 cm)
- 1 stampo plumcake (25 cm)

Tutti gli stampi sono realizzati in acciaio Hi-Top con rivestimento antiaderente doppio strato Ilaflon Special.

Chocoforme gift box contains:

- 1 springform 1 base with leakproof base (ø 26 cm)
- 1 flan tin (ø 28 cm)
- 1 loaf tin (25 cm)

All these moulds are made of Hi-Top steel with a double layer of Ilaflon Special non-stick coating.

Set 10 pezzi pizza

Gift box (10 pcs set)
Boîte cadeau (lot de 10 pièces)
Geschenkspaket (10 Stück)
Caja regalo (10 piezas)



CODE	CM	PACK	EAN
27514RK	34 x 34 x 8	4	8006043 275148

Confezione: scatola / Packaging: box

La scatola contiene:

- 1 griglia porta pizze (la struttura d'acciaio che permette di cuocere contemporaneamente 4 pizze)
- 4 tegami pizza da ø 32 cm
- 4 coltelli pizza e 1 rotella taglia pizza in nylon, da utilizzare anche sui tegami perché non graffia la superficie antiaderente e ne lascia intatte le caratteristiche di antiaderenza.

Tutti gli stampi sono realizzati in acciaio Hi-Top con rivestimento antiaderente Skandia Xtreme Plus doppio strato.

The box contains:

- 1 Pizza Rack (a steel wire holder that permits to bake 4 pizzas at the same time)
- 4 pizza tins (ø 32 cm)
- 4 pizza knives and 1 nylon pizza cutter, suitable to slice the pizza directly in the tin, as it doesn't damage the non-stick surface.

All these moulds are made of Hi-Top steel with Skandia Xtreme Plus double layer non-stick coating.



I love pizza - 5 pezzi

Set 4 tegami pizza + supporto in acciaio
Set 4 pizza tins with steel grill rack
Lot 4 moules à pizza avec support en acier
4 Pizzaform+pizzabäcker-set
Set 4 bandejas pizza + soporte en acero



CODE	CM	PACK	EAN
27516RK	31 x 31 x 5	4	8006043 013818

Confezione: scatola / Packaging: box

La scatola contiene:

- 1 griglia porta pizze (la struttura d'acciaio che permette di cuocere contemporaneamente 4 pizze)
- 4 tegami pizza da ø 28 cm che garantiscono la cottura perfetta e la facile sformatura di pizze di tutti i generi (realizzati in acciaio con rivestimento antiaderente Skandia Xtreme Plus doppio strato).

The box contains:

- 1 Pizza Rack (a steel wire holder that permits to bake 4 pizzas at the same time)
- 4 pizza tins (ø 28 cm) made of Hi-Top steel with Skandia Xtreme Plus double layer non-stick coating.

Anello regolabile tondo

Round extendable cake ring
Cadre à pâtisser réglable rond
Runder verstellbarer Tortenring
Molde redondo extensible

CODE	CM	H CM	PACK	EAN
15689R	ø 16	6	6	8006043 001501
	▼			
	ø 28			

Confezione: astuccio appendibile / Packaging: hangable box



Anello regolabile rettangolare

Rectangular extendable cake ring
Cadre à pâtisser réglable rectangle
Rechteckiger verstellbarer Backrahmen
Molde rectangular extensible

CODE	CM	H CM	PACK	EAN
15690R	18 x 27,5	5	6	8006043 001518
	▼			
	33 x 52,5			

Confezione: astuccio appendibile / Packaging: hangable box







Guardini®

ESPOSITORI DISPLAYS



Guardini propone i **box promozionali**, utili e versatili, adatti per tutti i momenti promozionali dell'anno. **Istituzionali, adattabili a varie linee o dedicati a singoli prodotti**, sono ideali per le varie **esigenze promozionali** e perfetti **per allestire il punto vendita** in modo colorato e attraente.

Guardini offers a variety of useful and versatile **display boxes**, suitable for **sales promotions** all year round and **customizable** for single or multiple products. Besides being ideal for a wide variety of **promotional needs**, they add colour and appeal to **every store**.

Mini display Istituzionale

*Cubic mini box
Mini présentoir cubique
Kubisch Mini Box
Mini expositor cubico*



CM	H CM
40 x 40	76

Mini pall box

*Mini pall box
Mini pall box
Mini pall box
Mini pall box*



CM	H CM
80 x 60	45 (senza crowner - without crowner)

Pall box

*Pall box
Pall box
Pall box
Pall box*



CM	H CM
80 x 60	82 (senza crowner - without crowner)

Mini display Pizza

*Cubic mini box
Mini présentoir cubique
Kubisch Mini Box
Mini expositor cubico*



CM	H CM
40 x 40	76

Mini display Easy Bake

*Cubic mini box
Mini présentoir cubique
Kubisch Mini Box
Mini expositor cubico*



CM	H CM
60 x 40	100

Espositore Easy Bake

*Display
Présentoir
Display
Expositor*



CM	H CM
57,5 x 38	112



Guarda i video Guardini sul nostro canale YouTube
Watch Guardini's videos on our YouTube channel

Guardini, il piacere italiano di cucinare!



*Guardini, Italian cooking delight!
Guardini, le délice de la cuisine italienne!
Guardini, italienischer Kochgenuss!
Guardini, delicia de la cocina italiana!*

GUARDINI, azioni concrete per un futuro sostenibile per tutti.



*GUARDINI, concrete actions for a sustainable future for everyone.
GUARDINI, des actions concrètes pour un avenir durable pour tous.
GUARDINI, konkrete Aktionen für eine nachhaltige Zukunft für alle.
GUARDINI, acciones concretas para un futuro sostenible para todos.*

Nuova collezione XBake.



*New collection, XBake.
Nouvelle collection XBake.
Neue Kollektion XBake.
Nueva colección XBake.*

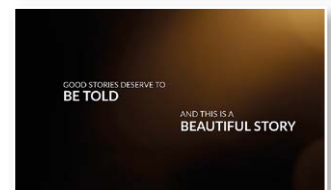



Guarda i video Guardini sul nostro canale YouTube
Watch Guardini's videos on our YouTube channel

Linea B-Nat: sostenibilità e qualità in una collezione 100% Made in Italy.



B-Nat line: sustainability and quality in a 100% Made in Italy collection.

Ligne B-Nat : durabilité et qualité dans une collection 100% Made in Italy.

B-Nat-Linie: Nachhaltigkeit und Qualität in einer 100% Made in Italy-Kollektion.

Linea B-Nat: sostenibilidad y calidad en una colección 100% Made in Italy.



Tampografia



Pad printing



Tortiera apribile 2 fondi



Springform 2 bases | Moule démontable 2 fonds
Springform+Rohrboden | Molde desmontable 2 fondos





Guarda i video Guardini sul nostro canale YouTube
Watch Guardini's videos on our YouTube channel

Stampo crostata
con fondo smontabile



Loose base flan tin | Moule à tarte avec fond amovible
Obsttorten mit abnehmbar boden | Molde rizado móvil



Stampo da forno
con coperchio per trasporto



Baking mould with carrying lid
Plat à four avec couvercle de transport
Brat- und Backform mit Transporthaube
Molde de horno con tapa transportable



Teglia rettangolare estensibile



Adjustable baking tray | Plaque à four rectangulaire extensible
Ausziehbar Backform | Bandeja rectangular extensible





Guarda i video Guardini sul nostro canale YouTube
Watch Guardini's videos on our YouTube channel

**Roasting Set
3 pz.**



Roasting Set - 3 pcs.



**Set 4 tegami pizza
+ griglia porta pizze**



Pad Set 4 pizza tins with steel grill rack
Lot 4 moules à pizza avec support en acier
4 Pizzaform+pizzabäcker-set
Set 4 bandejas pizza + soporte en acero printing



Coppapasta



Food rings | Cercles à pâtisserie
Food-Ring | Aros







GUARDINI S.p.A
Via Cravero 9 - 10088 Volpiano (To) - ITALY
Tel +39 011 9952890 - Fax +39 011 9952142
info@guardini.com
www.guardini.com