

Cook King

PASSION FOR COOKING

CATALOGUE 2023

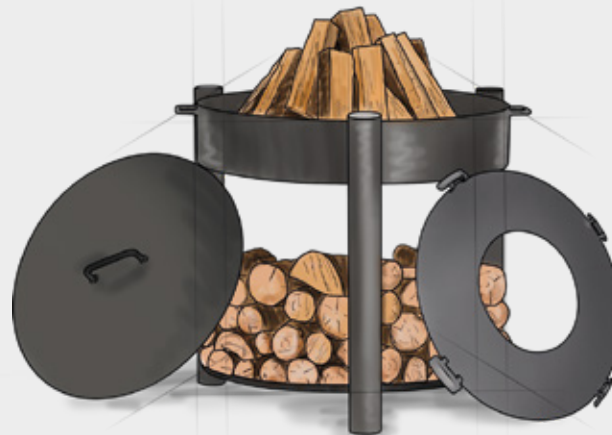



About us 3

Handmade manufacturer 4-5

Why you should choose Cook King? 6-7

Our designer..... 8-9

 **Fire bowls** 11-29

 **Multifunctional fire bowls**..... 30-31

 **Premium fire bowls** 32-34

 **Premium barbecue** 35-36

 **Garden stoves**..... 37-40

 **Camping ovens** 41

 **Fire baskets** 42-45

 **Tripod Grills** 46-52

 **Tripod pots** 53-54

 **Accessories** 55-68

 **Wood racks** 69-75





Passion for cooking

We've been producing and shipping grills, fire bowls, garden stoves and outdoor cooking equipments for over 7 years. Currently, the Cook King brand can be found in Europe, Asia and Africa.

This is how we share our passion for cooking. Our aim is to make our customers feel the joy and pleasure of preparing and having outdoor meals together. We design our products so that they help throw unforgettable parties and let our customers enjoy the time spent with their family and friends.

What motivates us the most? The vision of you standing in your garden and watching tremendous fun going on around our fire bowls and grills. We want you to be able to say the following in such situation: This is exactly what our home is like: warm, safe and reliable.

HANDMADE is a guarantee of tradition and quality!



How does the production process ensure the highest quality of our products?

All Cook King products are hand-made. The massive structure of our products includes numerous elements that are matched and connected to each other properly.

We only use materials from European steelworks holding necessary certificates and approvals confirming their quality and origin.

Our products are made of thick steel elements (2-5 mm), due to which we can guarantee their excellent condition and durability.

HANDMADE - tradition and quality guaranteed!





Why you should choose Cook King?



We offer exclusivity to our distributors

- Become our exclusive distributor and enjoy full support from our brand. By gaining full freedom to operate on specific market, you can attain competitive advantage and increase your profits. Your marketing efforts won't be vain, because there will be no other competition.



0,05% - customer complaints rate

- Low rate of customer complaints, which equals 0,05%, ascertains us, that nearly all customers will be satisfied with their purchase. Moreover, if there is no need for creating another department for complaints management and after-sales service, you will be able to focus on different aspects of business, saving your time and money.



Remarkable patterns and design of the products

- Unique patterns and design of our products guarantee that your business will stand out from the rest of the competition. Due to this fact, you - our exclusive distributor - are able to offer something special to your customers.



Wide range of equipment and accessories

- By providing a wide range of equipment and accessories, we solve the problem of one-off deals and manage to retain customers for long. Our research indicates that over 60% of customers decides to supplement their previous purchase with more accessories within next season, which means potentially regular source of income for the distributor.



High margin

- Our products are the perfect opportunity for exclusive distributor, to increase their profits. We offer high margin that allows you to run stable and profitable business.



Professional marketing materials: photographs, descriptions and films

- Our company guarantees professional marketing materials, including photographs, product descriptions and films, which minimises involving distributor in the process of launching a new product. The materials are updated and extended every year. Responsibility for marketing materials lies with professional advertising agency.



HAND MADE and MADE IN EUROPE production

- HAND MADE' products, as well as products 'MADE IN EUROPE' are trends, which have been in demand for a long time. Customers who were informed about these features become aware of high-quality of the assortment. Due to this fact, they accept higher selling price, knowing that the product is unique and worth its price.

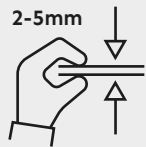

We use 2,0-5,0mm thick steel for the production

- Thickness of steel is one of the key characteristics of our products, which determines its long lifespan and durability. It results in minimal percentage of complaints and customers' dissatisfaction.



Fully welded structure of our products

- Our products don't require assembly, which enables customers to use them right after unpacking. Due to fully welded structure, we eliminated the problem of putting elements together by tightening the screws and the problem of weakening its structure after some time of exploitation.



ECO products renewable in 99,5%

- Our brand represents not only high-quality and durability, but also ecological responsibility. We make all our products out of 100% renewable steel, which enables recycling these products in 99,5%. With this solution, our products fit into current trends and meet our customers' expectations. This is how we care about our environment, ourselves and future generations.



Why You Should Choose
Cook King?

Scan the QR code
and see for yourself !

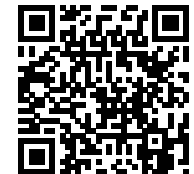

About Cook King products

What are the characteristics of our products?

It is the quality of Cook King that our customers value us most for. We owe our reputation to the simple and timeless style of our products, solid workmanship and comfort of use. Thanks to these features our customers can enjoy our products for many years.

What is the secret of the highest quality of Cook King products?

We believe that you have to deliver excellent quality as early as at the design stage in order to provide a high-quality product. Each Cook King product is based on our own product design made from scratch. We carefully design our products so that people from all over the world who love cooking and meeting friends outdoors can enjoy their time together. That is why our designer always looks for the best solutions to make his products stylish, solid, safe and easy to use. Once the design is ready, we start with the production process. Each product is made by hand with the utmost care.

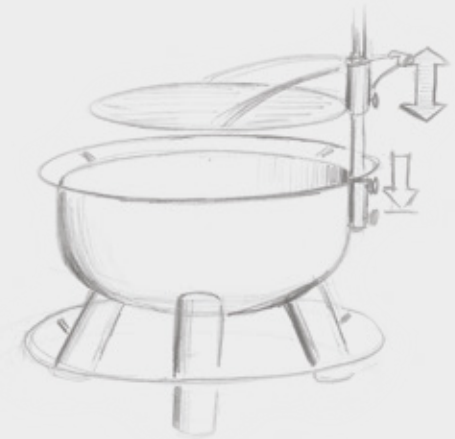
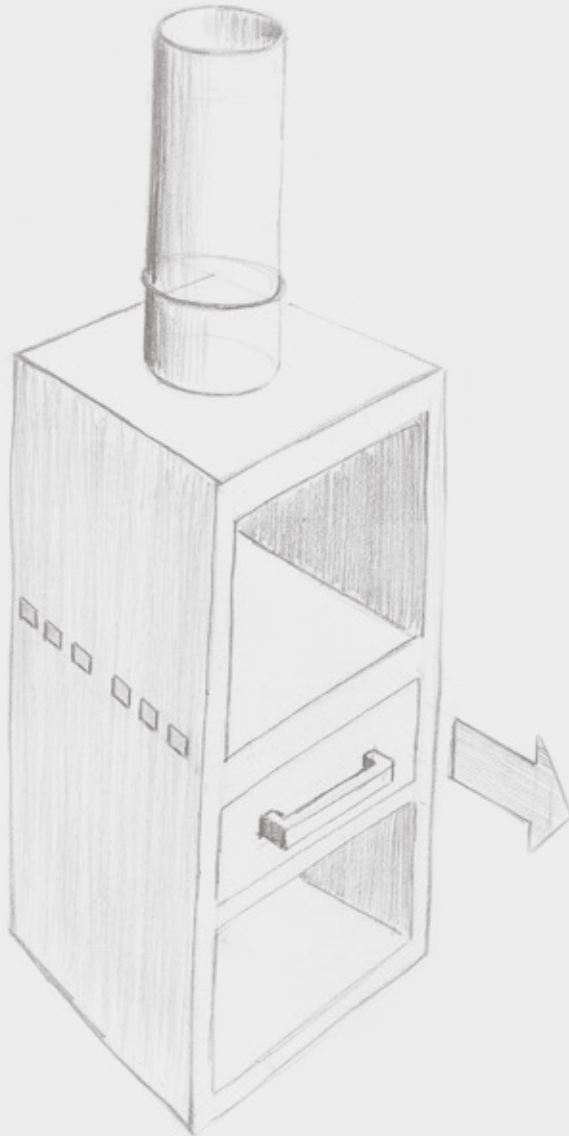

It is our designer who gives our brand its character!

All our products are designed by one man. Thanks to his passion, commitment and years of experience each of our products is planned to the smallest detail.

He travels all around the world finding inspiration in different cultures, due to which Cook King products are popular and appreciated by customers from various countries.

When starting a new project, he keeps asking himself: How will the product look in a garden? How can I make it solid, stable and safe? Will it be easy to use? Will it be a pleasure to use it?

Whenever asked about the most important aspects of designing a product, he says: **QUALITY, STYLE AND DURABILITY.**

And this is what Cook King products are all about: high-quality grilling tools thanks to which customers all over the world can enjoy dishes flavored with wind and fire.

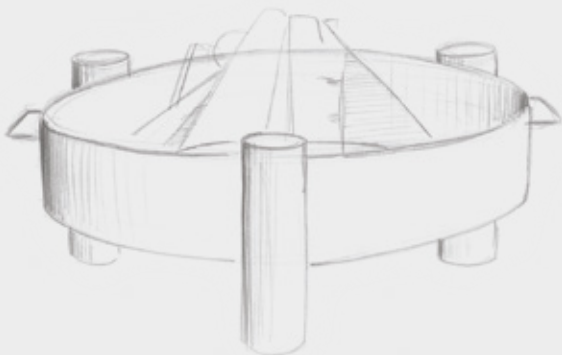



Dimensions of tripod grills



Dimensions of fire bowls



Ø 60 cm

Ø 70 cm

Ø 80 cm

Ø 100 cm

Fire bowls





Fire Bowl "VIKING"

Size: Symbol:

60 cm 111260

70 cm 111261

80 cm 111262

100 cm 111263

video on YouTube



video on YouTube



Accessories for fire bowl in size:

60/70/80/100 cm



60/70/80/100 cm



80/100 cm



60/70/80/100 cm



60/70/80 cm



60/70/80 cm





Many options of accessories to choose from.

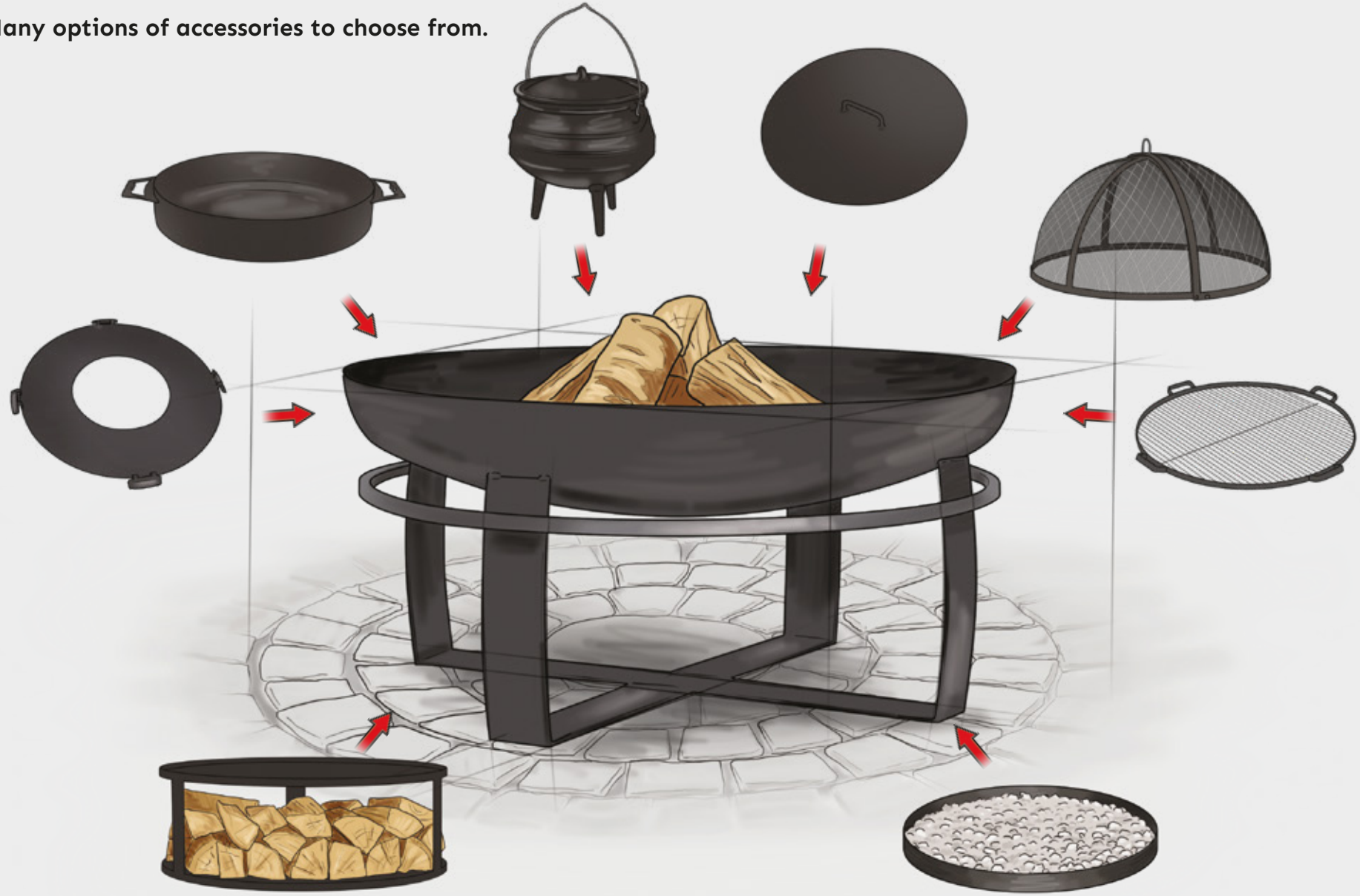



BEST SELLER

Fire Bowl "PORTO"

Size:	Symbol:
60 cm	111265
70 cm	111266
80 cm	111267
100 cm	111268

video on YouTube

SCAN

video on YouTube

SCAN

video on YouTube

SCAN

Accessories for fire bowl in size:

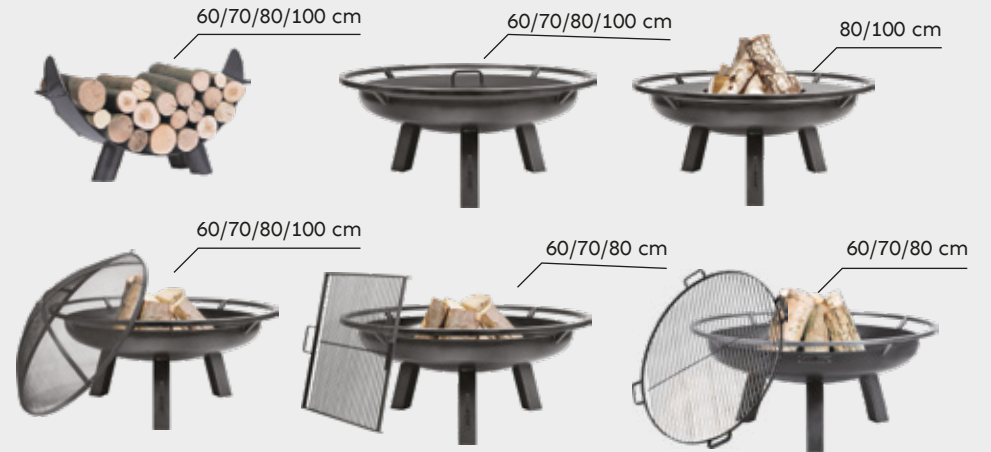

Fire Bowl „INDIANA“

Size:	Symbol:
60 cm	111346
70 cm	111347
80 cm	111348
100 cm	111349

Accessories for fire bowl in size:





Fire Bowl „SANTIAGO“

Size:	Symbol:
60 cm	111372
70 cm	111373
80 cm	111374
100 cm	111375

Accessories for fire bowl in size:



Fire Bowl "POLO"

Size:	Symbol:
60 cm	111256
70 cm	111257
80 cm	111258
100 cm	111259

video on YouTube

SCAN

Accessories for fire bowl in size:





Fire Bowl "BALI"

Size:	Symbol:
60 cm	111230
70 cm	111231
80 cm	111232
100 cm	111242

video on YouTube



Accessories for fire bowl in size:



Fire Bowl "PALMA"

Size:	Symbol:
60 cm	111233
70 cm	111234
80 cm	111235
100 cm	111244



Accessories for fire bowl in size:

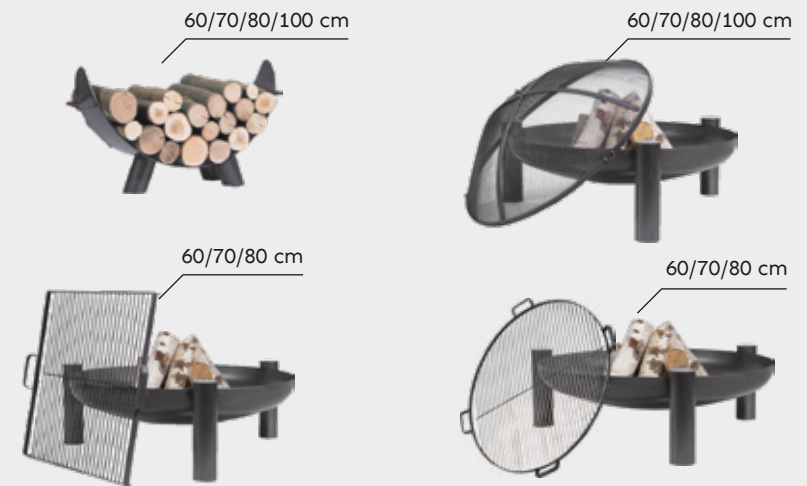



Fire Bowl "PANAMA"

Size:	Symbol:
60 cm	111376
70 cm	111377
80 cm	111378
100 cm	111379

Accessories for fire bowl in size:





Fire Bowl XXL "PALERMO"



Size:	Symbol:
80 cm	111561

Accessories for fire bowl in size:

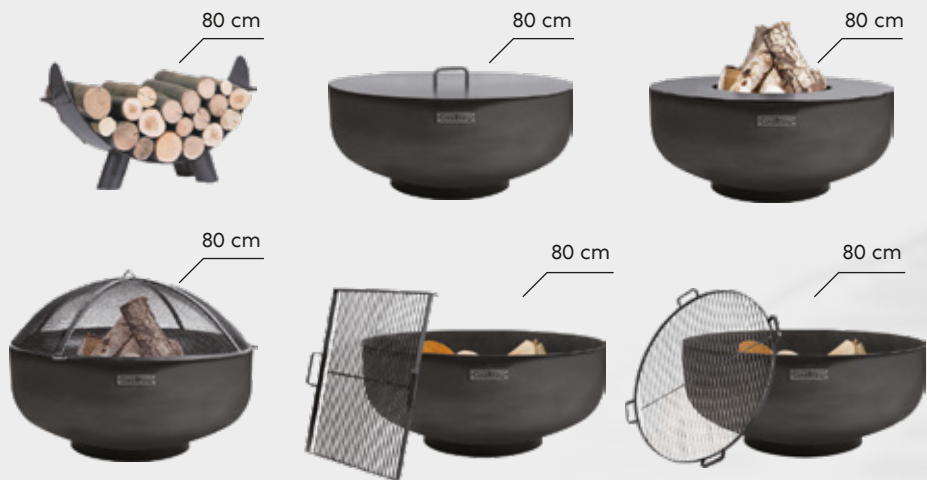



Fire Bowl XXL "VIKING"



Size: 80 cm Symbol: 111562

Accessories for fire bowl in size:

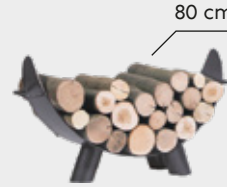

Fire Bowl XXL "PORTO"

Size: 80 cm Symbol: 111563

Accessories for fire bowl in size:

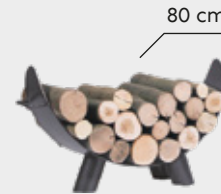



Fire Bowl "TUNIS"

Size:	Symbol:
60 cm	111297
70 cm	111298
80 cm	111299

Accessories for fire bowl in size:

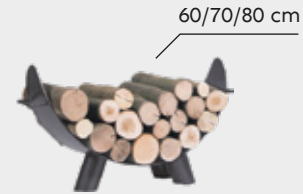

Fire Bowl "HAITI"

Size:	Symbol:
60 cm	111236
70 cm	111237
80 cm	111238

Accessories for fire bowl in size:

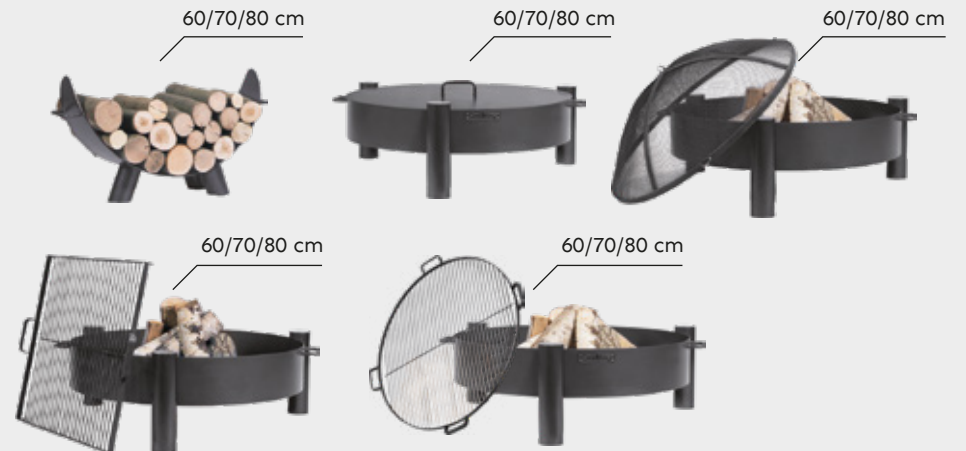

video on YouTube





Fire Bowl "MONTANA"

Size: Symbol:

60 cm 111246

70 cm 111247

80 cm 111248

video on YouTube



Accessories for fire bowl in size:



60/70/80 cm

60/70/80 cm

60/70/80 cm

60/70/80 cm

60/70/80 cm



Fire Bowl "MONTANA" high

Size:	Symbol:
60 cm	111361
70 cm	111362
80 cm	111363

video on YouTube



Accessories for fire bowl in size:

60/70/80 cm

60/70/80 cm

60/70/80 cm

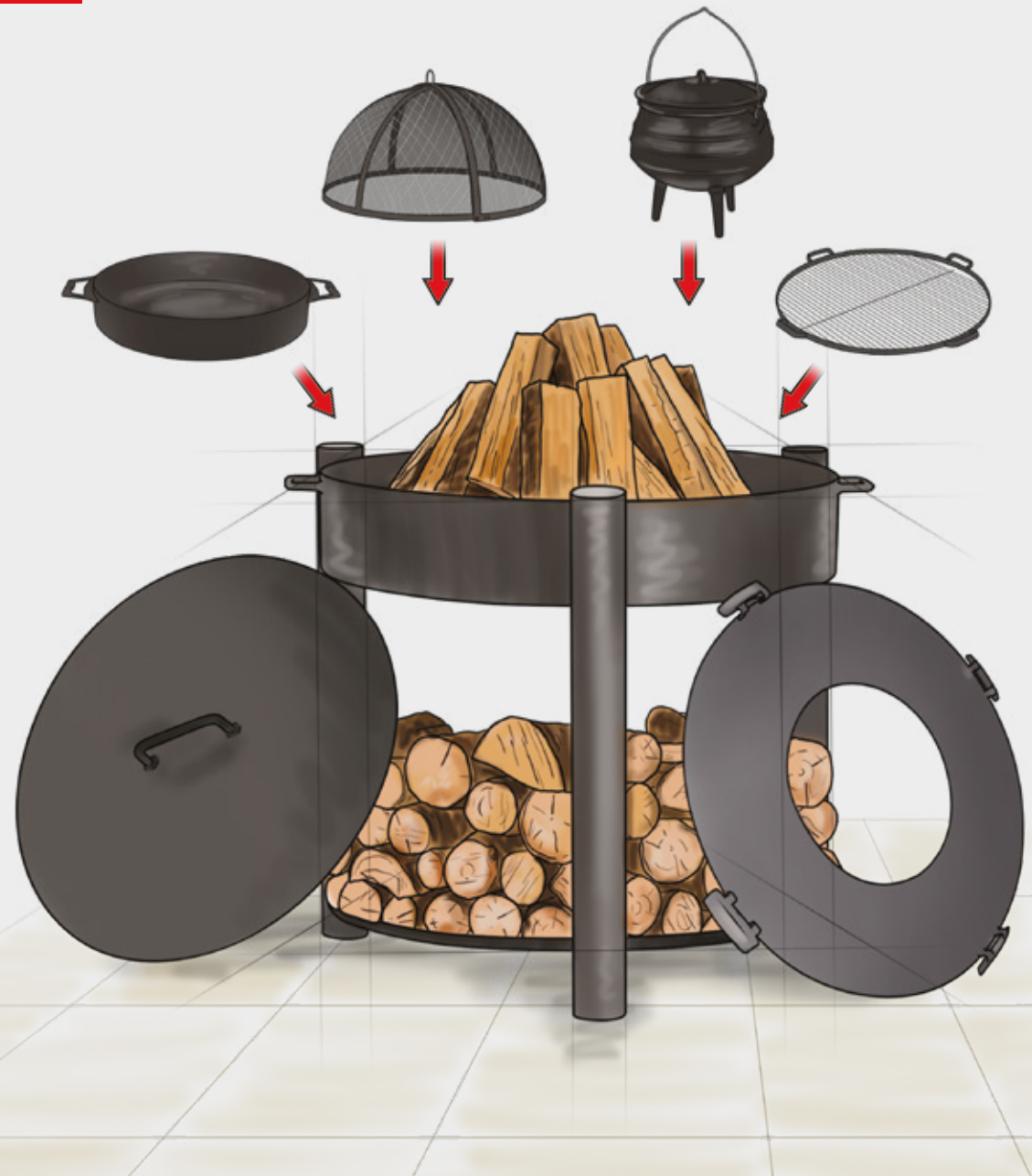



Fire Bowl "CUBA"

Size: 70x70cm Symbol: 111243

Accessories for fire bowl in size:

70x70 cm



70x70 cm



Fire Bowl "SQUARE"

Size: 70x70cm Symbol: 111370

Accessories for fire bowl in size:

70x70 cm



70x70 cm





Fire Bowl "BRASIL"

Size: 70x70cm
Symbol: 111343

Accessories for fire bowl in size:



Outdoor Wood Rack "FUEGO"
Symbol: 333243





NEW

Now it's possible to personalize **Your Fire Bowl**

We are giving you the opportunity to create your individual design of a firebowl adapting it to the current market trends, the image of your company and the requirements of customers.

The edge of the product will be cut out of a thick sheet of steel by a CNC laser and welded to the bowl composing a massive construction.

This project gives you the unrestricted opportunity to develop your own design.
The only thing that can limit the project is your own imagination!

IDEAL PRESENT! You can create **YOUR FIREBOWL**

- with a company logo
- with a flag of a country or a city
- with the flag of your favorite sports club
- with any advertising slogan
- with a name

Minimum order quantity – 30 pieces





Fire Bowl "FIRE"

Size: Symbol:

80 cm 111282

Accessories for fire bowl in size:

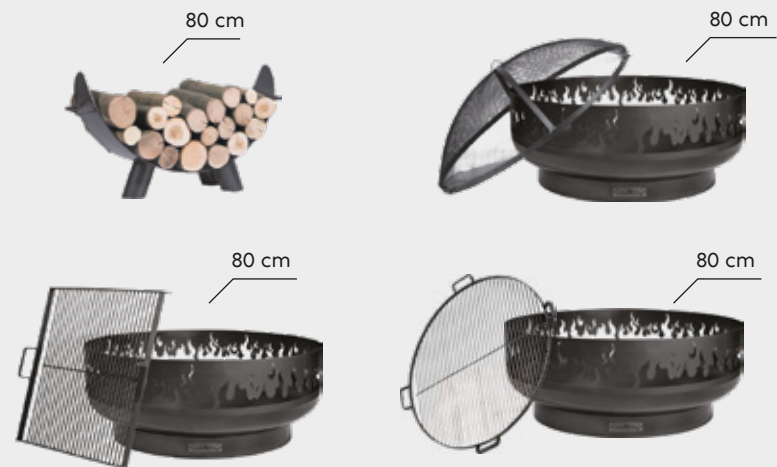

Fire Bowl "BOSTON"

Size: Symbol:

80 cm 111283

video on YouTube



Accessories for fire bowl in size:





Fire Bowl "TORONTO"



Size: Symbol:

80 cm

111286

video on YouTube



Accessories for fire bowl in size:

80 cm



80 cm



80 cm



80 cm





Fire Bowl "FOREST"



Size: Symbol:

80 cm

111289

video on YouTube



Accessories for fire bowl in size:

80 cm



80 cm



80 cm



80 cm





Fire Bowl "BOURBON"

Size:	Symbol:
60 cm	111380
70 cm	111381
80 cm	111382



Fire Bowl "BRONSON"

Size:	Symbol:
70x70cm	111387
80x80cm	111388



Fire Bowl "BLAZE"

Size:	Symbol:
60 cm	111384
80 cm	111385



Multifunctional Fire Bowl "MONTANA X" with 60 cm Grate



Bowl size:	Grate size:	Symbol:
80 cm	60 cm	111000

video on YouTube



video on YouTube



video on YouTube



Example functions with plate



with grate



with pan





Multifunctional Fire Bowl "BANDITO" with 60 cm Grate

Bowl size:	Grate size:	Symbol:
80 cm	60 cm	111355

video on YouTube

SCAN



Example functions with plate



with grate



with pan

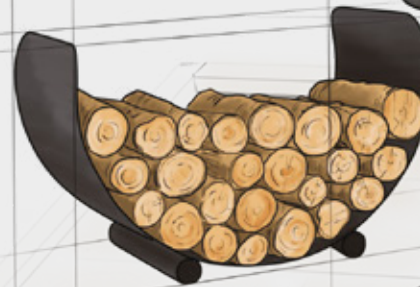

Premium fire bowls





Premium Deep Fire Bowl "DALLAS"

Size:	Symbol:
85 cm	111294





Premium Deep Fire Bowl "KONGO"

Size: 85 cm
 Symbol: 111295



Premium Deep Fire Bowl "FAT BOY"

Size: 85 cm
 Symbol: 111296

Accessories for fire bowl in size:



Accessories for fire bowl in size:





SANTOS

SYMBOL: 111490

DIAMETER: 85 cm



PREMIUM product

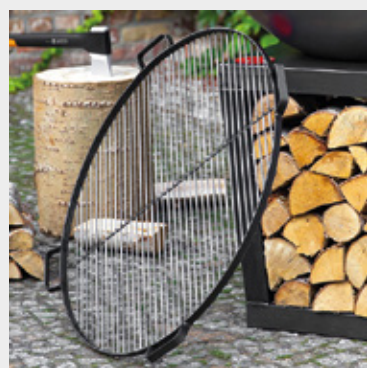

Grill grate 80 cm
Symbol: 111273



Lid with rant 86 cm
Symbol: 111325



Mesh Spark Screen 79 cm
Symbol: 111312



Grill Plate 82 cm
Symbol: 222380



Wood Rack "CORNEL"

Symbol: 333232

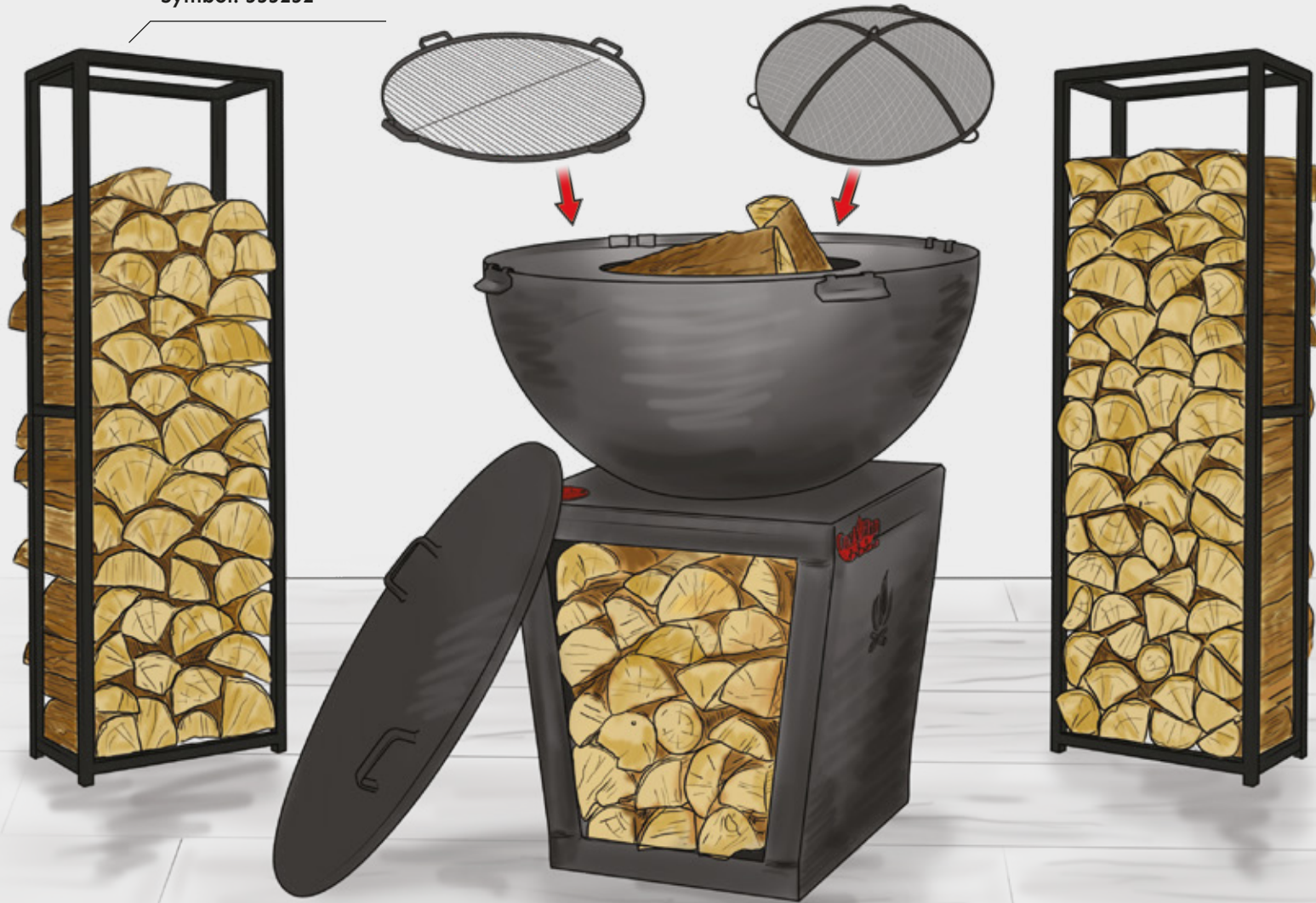

CookKing

Garden stoves





Garden Stove "FARO"

Diameter: Height: Symbol:

40 cm 158 cm 111480

video on
YouTube



Garden Stove "LIMA"

Size: Symbol:

50x33x108 cm 111483

video on
YouTube



Garden Stove "ROSA"

Size: Symbol:

40x40x150 cm 111485

video on
YouTube



Garden Stove "HAWANA"

Size: Symbol:

50x33x108 cm 111484

video on
YouTube





Garden Stove "ANKARA"

Size: Symbol:

50x33x108 cm 111486

video on YouTube



SCAN



Garden Stove "VENTO"

Size: Symbol:

50x47x150 cm 111500



Garden Stove "AVANGARDO"

Size: Symbol:

50x33x108 cm 111487

video on YouTube



SCAN



Outdoor Wood Rack
"VENTO"

Symbol: 333245

Optional high-temperature
glass in the door

Garden Stove „VENTO“
with Baking Oven Function

Size: Symbol:

50x47x150 cm 111501

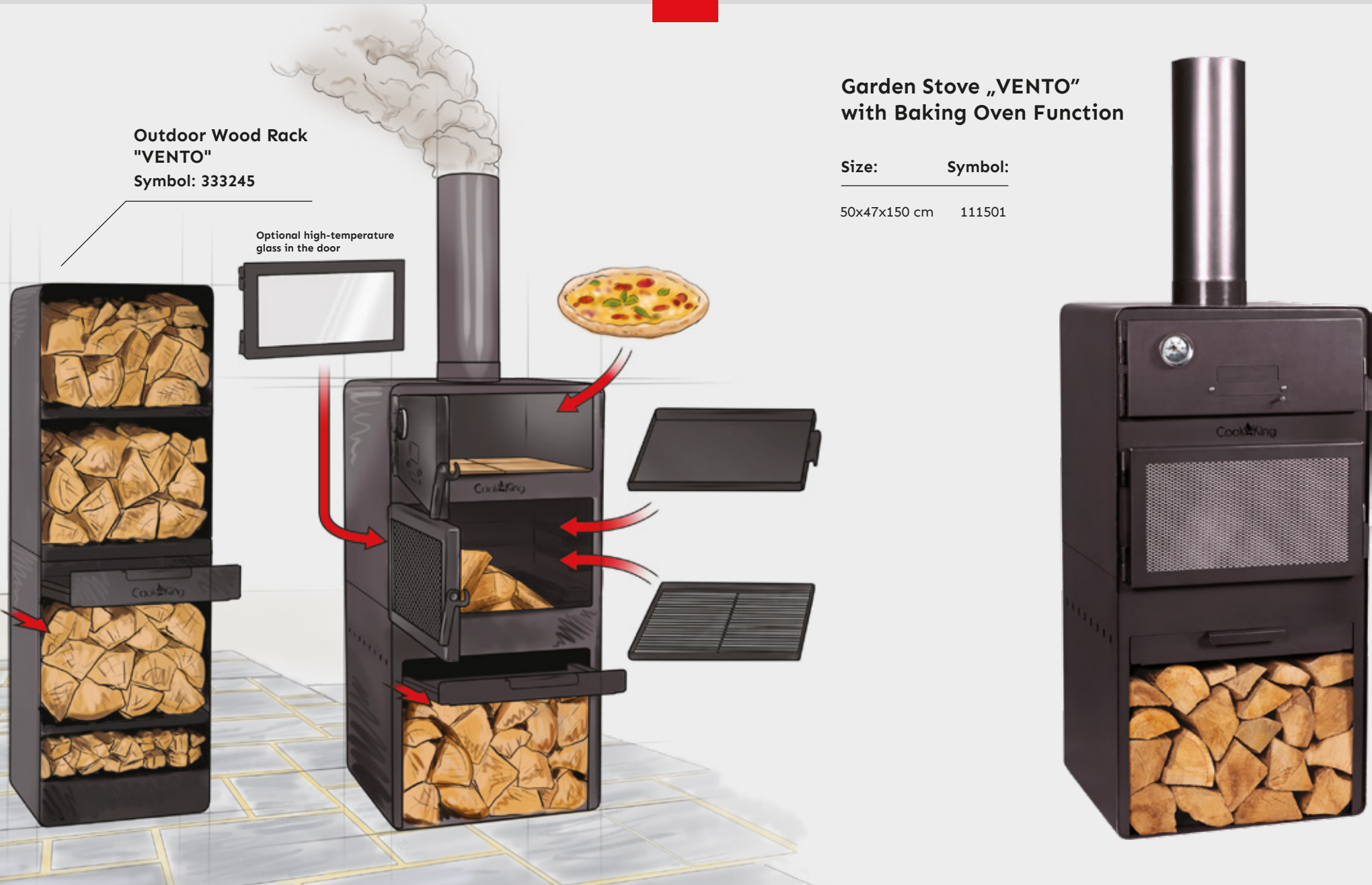



Camping Oven „BURNER“

Size: 28x45x82 cm
Symbol: 111510



Camping Oven „BURNER“ with Fireclay Iining

Size: 28x45x82 cm
Symbol: 111511

Fire baskets

BEST QUALITY
HANDMADE





BEST SELLER

Fire Basket "VERONA"

Size: Symbol:

60 cm 111452

video on YouTube SCAN

video on YouTube SCAN

Accessories for fire bowl in size:



Grill grate



Base plate



REMOVABLE BASE

Fire Basket "KATAR"

Size: Symbol:

60 cm 111454

video on YouTube SCAN

Accessories for fire bowl in size:



Grill grate



Base plate

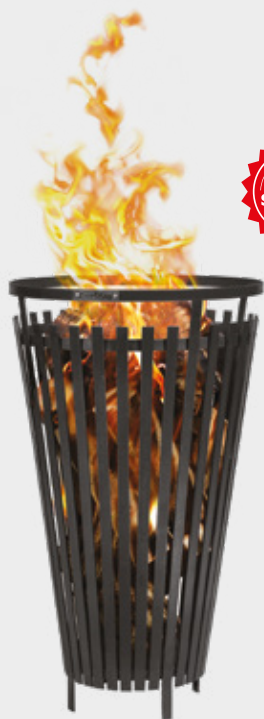

Fire Basket "FLAME"

Size: Symbol:

45 cm

111450

video on YouTube



Accessories for fire bowl in size:



Grill grate



Base plate





**Fire Basket
for Swedish Torches "PEDRO"**

Size: 20 cm
Symbol: 111461



**Fire Basket
for Swedish Torches "DAKAR"**

Size: 20 cm
Symbol: 111462

video on YouTube



**Fire Basket
for Swedish Torches "MALMO"**

Size: 20 cm
Symbol: 111463

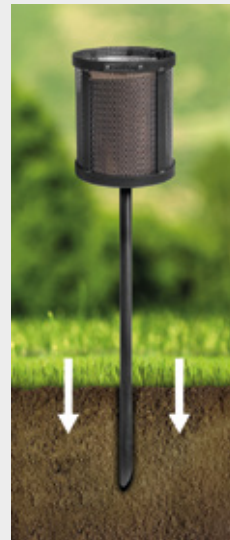

**Fire Basket
for Swedish Torches "BRUNO"**

Size: 20 cm
Symbol: 111464

video on YouTube

Tripod grills





BEST QUALITY
HANDMADE





180 cm Tripod with Natural Steel Grate

Size:	Symbol:
50 cm	111220
60 cm	111221
70 cm	111222
80 cm	111224

video on YouTube 



180 cm Tripod with Stainless Steel Grate

Size:	Symbol:
50 cm	111001
60 cm	111002
70 cm	111003
80 cm	111004

video on YouTube 



180 cm Tripod with 2 Natural Steel Grates

Size:	Symbol:
70cm + 40 cm	112440
80cm + 40 cm	112441



180 cm Tripod with 2 Stainless Steel Grates

Size:	Symbol:
70cm + 40 cm	112445
80cm + 40 cm	112446



200 cm Tripod with Natural Steel Grate

Size:	Symbol:
50 cm	22006
60 cm	22007
70 cm	22008
80 cm	22009

video on YouTube



200 cm Tripod with Stainless Steel Grate

Size:	Symbol:
50 cm	21010
60 cm	21011
70 cm	21012
80 cm	21013

video on YouTube



200 cm Tripod with 2 Natural Steel Grates

Size:	Symbol:
70cm + 40 cm	22450
80cm + 40 cm	22451



200 cm Tripod with 2 Stainless Steel Grates

Size:	Symbol:
70cm + 40 cm	22452
80cm + 40 cm	22453



180 cm Tripod with Natural Steel Wok

Size:	Symbol:
60 cm	111010
70 cm	111011



200 cm Tripod with Natural Steel Wok

Size:	Symbol:
60 cm	111013
70 cm	111014



180 cm Tripod with Natural Steel Grate + Winch

Size:	Symbol:
50 cm	111350
60 cm	111351
70 cm	111352
80 cm	111353

video on YouTube



180 cm Tripod with Stainless Steel Grate + Winch

Size:	Symbol:
50 cm	111356
60 cm	111357
70 cm	111358
80 cm	111359

video on YouTube





200 cm Tripod with Natural Steel Grate + Winch

Size:	Symbol:
50 cm	22370
60 cm	22371
70 cm	22372
80 cm	22373

video on YouTube
SCAN



200 cm Tripod with Stainless Steel Grate + Winch

Size:	Symbol:
50 cm	21375
60 cm	21376
70 cm	21377
80 cm	21378

video on YouTube
SCAN



180 cm Tripod with Natural Steel Wok + Winch

Size:	Symbol:
60 cm	111020
70 cm	111021

video on YouTube
SCAN



200 cm Tripod with Natural Steel Wok + Winch

Size:	Symbol:
60 cm	111025
70 cm	111026

video on YouTube
SCAN





160 CM Tripod Grill with Natural Steel Grate

Size:	Symbol:
50 cm	111820
60 cm	111821



160 cm Tripod Grill with stainless steel grate

Size:	Symbol:
50 cm	111830
60 cm	111831



210 cm Tripod "TIPI" with Natural Steel Grate

Size:	Symbol:
50 cm	111438
60 cm	111439
70 cm	111440
80 cm	111441



210 cm Tripod "TIPI" with Stainless Steel Grate

Size:	Symbol:
50 cm	111442
60 cm	111443
70 cm	111444
80 cm	111445



210 cm Tripod "TIPI" with 2 natural steel grates

Size:	Symbol:
70cm + 40 cm	111446
80cm + 40 cm	111447



210 cm Tripod "TIPI" with 2 Stainless Steel Grates

Size:	Symbol:
70cm + 40 cm	111448
70cm + 40 cm	111449



Fire Bowl „INDIANA“
Symbol: 111348

Natural Steel Wok
Symbol: 111348

360°

Lid with Rim
Symbol: 111332

Cast-iron African Pot
Symbol: 1214043



Tripod
pots





180 cm Tripod with Stainless Steel Pot

Size: Symbol:

10l 121407

14l 121408



180 cm Tripod with Stainless Steel Pot + Winch

Size: Symbol:

10l 121475

14l 121476



180 cm Tripod with Cast-iron African Pot

Size: Symbol:

6l 121450

9l 121451

13l 121452



180 cm Tripod with Cast-iron African Pot + Winch

Size: Symbol:

6l 121460

9l 121461

13l 121462

Accessories





Lid for Fire Bowl



Size:	Symbol:
60,5 cm	111300
70,5 cm	111301
80,5 cm	111302
101 cm	111306

Lid for Fire Bowl



Size:	Symbol:
62 cm	111303
72 cm	111304
82 cm	111305
101 cm	111307

Lid for Fire Bowl



Size:	Symbol:
71,5x71,5 cm	111308

Lid with Rim



Size:	Symbol:
61,5 cm	111330
71,5 cm	111331
81,5 cm	111332
86,5 cm	111325
102 cm	111333

video on YouTube





Lid with Rim

Size: Symbol:

72,5x72,5 cm 111318



Openable Mesh Spark Screen for Fire Bowl

Size: Symbol:

59 cm 111315

69 cm 111316

79 cm 111317



Fire Bowl Mesh Spark Screen

Size: Symbol:

59 cm 111310

69 cm 111311

79 cm 111312

99 cm 111313



video on YouTube



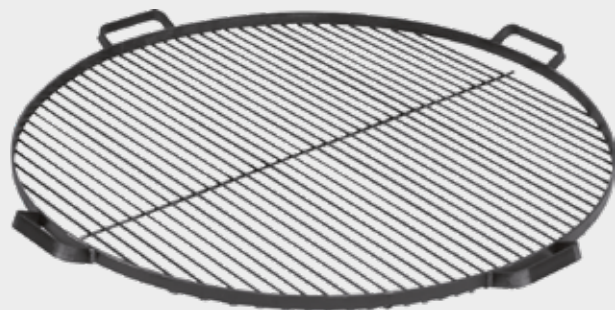

Natural Steel Grate with 4 Handles for Fire Bowl

Size: Symbol:

60 cm	111271
70 cm	111272
80 cm	111273



Stainless Steel Grate with 4 Handles for Fire Bowl

Size: Symbol:

60 cm	111284
70 cm	111285
80 cm	111274

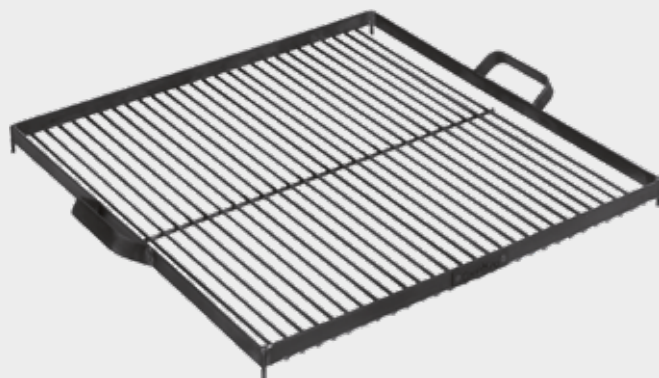

Natural Steel Grate for Fire Bowl

Size: Symbol:

44x44 cm for 60 cm fire bowl	1112260
50 x 50 cm for 70 cm fire bowl	1112261
58 x 58 cm for 80 cm and 70x70 cm fire bowl	1112262

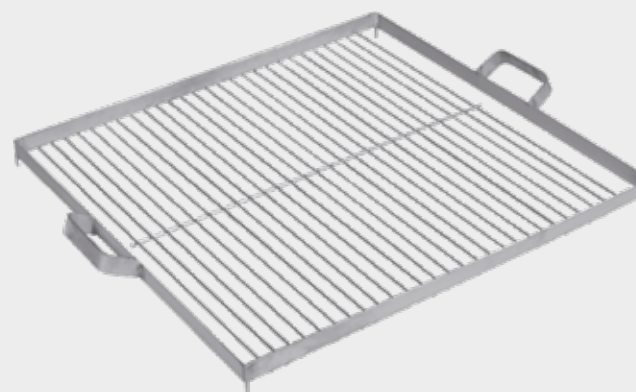

Stainless Steel Grate for Fire Bowl

Size: Symbol:

44x44 cm for 60 cm fire bowl	1112265
50 x 50 cm for 70 cm fire bowl	1112266
58 x 58 cm for 80 cm and 70x70 cm fire bowl	1112267

video on YouTube



Natural Steel Grate

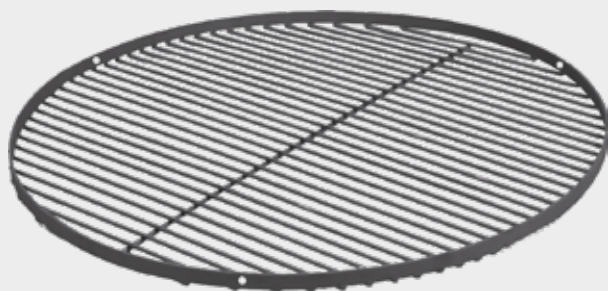

Size:	Symbol:
50 cm	111225
60 cm	111226
70 cm	111227
80 cm	111218
90 cm	111269
100 cm	111270

Stainless Steel Grate

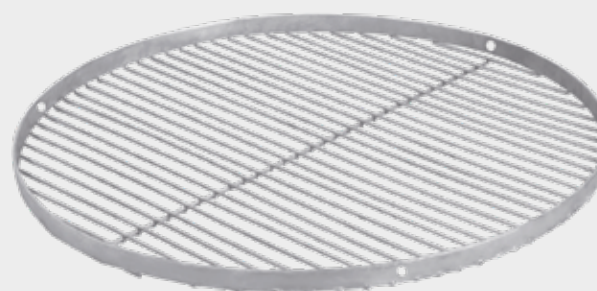

Size:	Symbol:
50 cm	1112290
60 cm	1112291
70 cm	1112292
80 cm	1112293

Grill Plate for Fire Bowl

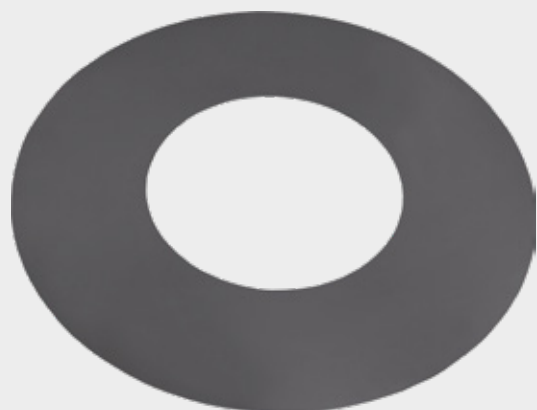

Size:	Symbol:
82 cm with 40 cm hole	222302
102 cm with 50 cm hole	222303

Stainless Grill Plate for Fire Bowl



Size:	Symbol:
82 cm with 40 cm hole	222402
102 cm with 50 cm hole	222403



Grill Plate for Fire Bowl with Grate

Size: **Symbol:**

82 cm 222305
with 40 cm grate

102 cm 222306
with 50 cm grate



Stainless Grill Plate for Fire Bowl with Grate

Size: **Symbol:**

82 cm 222405
with 40 cm grate

102 cm 222406
with 50 cm grate



Grill Plate for Fire Bowl 4 Handles

Size: **Symbol:**

78 cm 222388
with 36 cm hole

82 cm 222384
with 40 cm hole

98 cm 222389
with 46 cm hole

102 cm 222385
with 50 cm hole

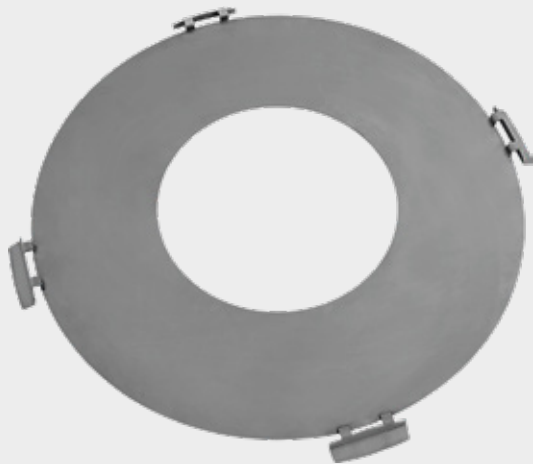

Stainless Grill Plate for Fire Bowl 4 Handles

Size: **Symbol:**

78 cm 222407
with 36 cm hole

82 cm 222408
with 40 cm hole

98 cm 222409
with 46 cm hole

102 cm 222410
with 50 cm hole

video on YouTube







Grill Plate for Fire Bowl with Grate and 4 Handles



Size: Symbol:

78 cm with 36 cm hole	222386
82 cm with 40 cm hole	222380
98 cm with 46 cm hole	222387
102 cm with 50 cm hole	222382

video on YouTube 



Stainless Grill Plate for Fire Bowl with Grate and 4 Handles



Size: Symbol:

78 cm with 36 cm hole	222411
82 cm with 40 cm hole	222412
98 cm with 46 cm hole	222413
102 cm with 50 cm hole	222414

Round Fire Bowl Base for Decorative Stones



Size: Symbol:

60 cm	111030
80 cm	111031
100 cm	111032
120 cm	111033



Square Fire Bowl Base for Decorative Stones



Size: Symbol:

60x60 cm	111035
80x80 cm	111036
100x100 cm	111037
120x120 cm	111038



Round Fire Bowl Base with Wood Storage



Size:	Symbol:
62 cm	111040
72 cm	111041
82 cm	111042
102 cm	111043

Fire Basket Base Plate



Size:	Symbol:
60 cm	111028
70 cm	111029

Spark Screen and Fire Bowl Poker



Size:	Symbol:
100 cm	111321



Fire Bowl Tripod

Size:	Symbol:
H= 23cm	111249



Natural Steel Pan with 2 Handles

Size:	Symbol:
50 cm	121201

video on YouTube



Natural Steel Pan with Long Handle

Size:	Symbol:
50 cm	121202



Holder for 50cm Steel Pan

Size:	Symbol:
40x40 cm	121209



Natural Steel Wok

Size:	Symbol:
60 cm	111015
70 cm	111016



Stainless Steel Goulash Pot

Size:	Symbol:
10l	1214014
14l	1214015



Cast-iron African Pot

Size:	Symbol:
6l	1214041
9l	1214042
13l	1214043

video on YouTube

SCAN



Natural Cast-iron Pan

Size:	Symbol:
26 cm	1214058
28 cm	1214059
30 cm	1214060

video on YouTube

SCAN



Natural Steel Grate with Handle for "BANDITO" and "MONTANA X" Fire Bowl

Size:	Symbol:
60 cm	121205



Natural Steel Pan with Handle for "BANDITO" and "MONTANA X" Fire Bowl

Size:	Symbol:
<hr/>	<hr/>
50 cm	121206



Natural steel grill plate with handle for "BANDITO" and "MONTANA X" Fire Bowl

Size:	Symbol:
<hr/>	<hr/>
50 cm	121208



Pot/Wok Hanger for "BANDITO" and "MONTANA X" Fire Bowl

Size:	Symbol:
<hr/>	<hr/>
	111360



Mast for "BANDITO" and "MONTANA X" Fire Bowl

Size:	Symbol:
<hr/>	<hr/>
77 cm	121207



180 cm Tripod

Size: Symbol:

180 cm 1112241



200 cm Tripod

Size: Symbol:

200 cm 1112242



180 cm Tripod + Winch

Size: Symbol:

180 cm 1112243



200 cm Tripod + Winch

Size: Symbol:

200 cm 1112244





160 cm Camping Tripod

Size:	Symbol:
160 cm	111900



210 cm Tripod "TIPI"

Size:	Symbol:
210 cm	1112248



Stainless Steel Chain Set for Grill Grate + 4x Carabiner Hooks

Size:	Symbol:
300 cm (1x150 cm + 3x50 cm)	1112245



Leather Apron by Cook King

Size:	Symbol:
	222400



Waterproof garden stove cover "FARO"

Size:	Symbol:
40 cm x 110 cm	222415



Waterproof garden stove cover "ROSA"

Size:	Symbol:
40x40x110 cm	222416



Waterproof garden stove cover "LIMA / HAWANA / ANKARA / AVANGARDO"

Size:	Symbol:
50x30x110 cm	222417



Wood racks



BEST QUALITY
HANDMADE





Wood Rack "MILA"

Size: _____ Symbol: _____

70x25x44 cm 333240



Wood Rack "FUEGO"

Size: _____ Symbol: _____

50x30x52 cm 333243



Wood Rack "TURYN"

Size: _____ Symbol: _____

70x36x45 cm 333241



Wood Rack "SEGAL"

Size: _____ Symbol: _____

40x30x74 cm 333244





Wood Rack "VENTO"

Size: 40x30x120 cm
Symbol: 333245



Fire bowls



Multifunctional fire bowls



Premium fire bowls



Premium barbecue



Garden stoves



Camping ovens



Fire baskets



Tripod grills



Tripod pots



Accessories



Wood racks



Wood Rack "CORNEL"



Size: _____ Symbol: _____

120x40x20 cm 333231

150x50x20 cm 333232

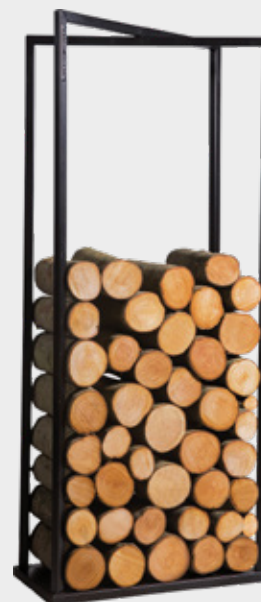

Wood Rack "LUIS"

Size: _____ Symbol: _____

120x40x20 cm 333242



Wood Rack "ATOS"



Size: _____ Symbol: _____

120x40x20 cm 333239

150x50x20 cm 333247





Wood Rack "SPIRAL"

Size:	Symbol:
80 cm	333238



Wood Rack "DAISY"



Size:	Symbol:
∅ 80 cm	333233
∅ 100 cm	333248



Wood Rack "DIEGO"

Size: Symbol:

∅ 80 cm 333237

∅ 100 cm 333249





Wood Rack "BERRY"

Size: _____ Symbol: _____

90x60x25 cm 333234



Wood Rack "CHERRY"

Size: _____ Symbol: _____

90x60x25 cm 333235



Wood Rack "ALDI"

Size: _____ Symbol: _____

60x90x25 cm 333236



Made
in Europe

HANDMADE



WARGO

Ul. Zakaszewskiego 10
66-300 Międzyrzecz



Poland

tel.: 0048 790 655 075

e-mail: office@cookking.com

www.cookking.com

Cook King
PASSION FOR COOKING